

# Facade Planner

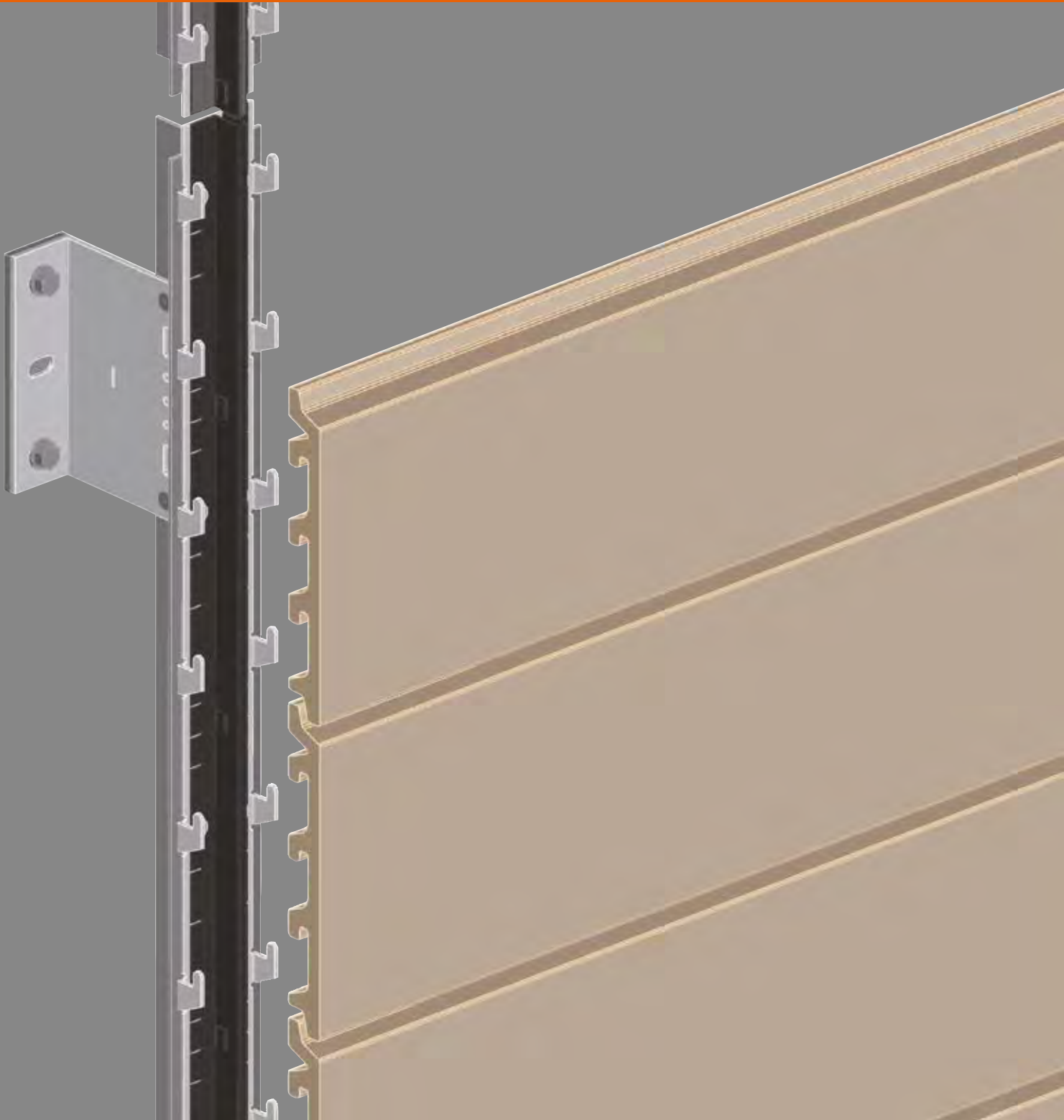

## Facade tiles



# Contents

Product overview .....	04
KERALIS quality .....	05
Rear-ventilated ceramic rainscreen facades .....	06 - 07
Base clinch rail system (BAS)	
BAS system description .....	08 - 11
BAS delivery programme .....	12
BAS-Flex holder system description .....	13 - 14
BAS-Flex holder delivery programme .....	15
BAS standard details .....	16 - 21
BAS installation of cut tiles.....	22 - 23
BAS on wooden primary substructure .....	24
BAS portrait installation .....	25
Adaptive system (ADS)	
ADS system description .....	26 - 32
ADS delivery programme .....	33
ADS standard details .....	34 - 39
ADS installation of cut tiles .....	40 - 41
ADS on wooden primary substructure .....	42 - 43
ADS T-Line .....	44
ADS Siding .....	45
ADS portrait installation .....	46 - 47
Permitted spans .....	48 - 49
Privacy and sun protection .....	50
Environmental declaration .....	51
Design basics .....	52 - 57
Colour overview .....	58 - 59

There is a copy of the latest version of the national technical approval at any time on our website at [www.tonality-facades.de](http://www.tonality-facades.de).

# Product overview

## Facade tiles

High quality, frost resistance and durability have been inherent characteristics of TONALITY facade tiles for decades. These high quality facade tiles distinguish themselves through their outstandingly high quality raw materials combined with their unique colours, range of surface finishes, highly attractive joint designs and practical installation-friendly technology. Ventilated rainscreen facade projects, whether new builds or refurbishments, when constructed from TONALITY facade tiles have proven themselves both to be highly reliable and to possess outstanding physical characteristics.

TONALITY facade tiles are certified by the German Institute Construction and Environment e.V. (IBU - Institut Bauen und Umwelt e.V.) with an environmental product declaration (EPD) in accordance with ISO 14025 and EN 15804.

TONALITY offers unique design opportunities for individual facades with standard formats from 150 x 300 mm up to 400 x 1,600 mm and a wide choice of finishes. TONALITY already offers a very wide spectrum of standard colours with the BRICK RED, NATUR, NUANCE, NOBLESSE COLOR and SIENA product series, as shown on pages 58/59.

Additional colours and surfaces are available on request.

## Privacy and sun protection

The Lamella, Baguette and Square Brise Soleil complement the TONALITY facade tile product range in the best way possible. The precast Brise Soleil elements are available in numerous standard dimensions and all the colours from the NATUR, BRICK RED, NUANCE and NOBLESSE COLOR series as shown on pages 58/59.

Additional formats, colours and shapes are available on request.

## Standard finishes

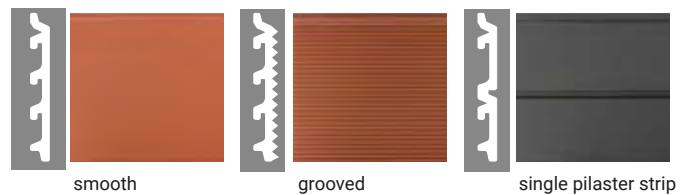

## Standard formats

Grid height (mm)	Min. grid width (mm)	Max. grid width (mm)
150	300	900
175	300	900
200	300	1,600
225	350	1,600
250	375	1,600
300	450	1,600
400	600	1,600



# KERALIS® Quality

## KERALIS sinter-firing process

### KERALIS Quality

- Innovative production process
- Meticulously prepared Westerwald clays
- Sinter firing at 1,200°C – high temperature firing
- Cutting-edge plant technology

### Your benefits

- Long lifespan under heavy loads
- Completely frost-resistant
- Low water absorption
- Low contamination
- Easy to clean



High firing factor



Protection from environmental influences

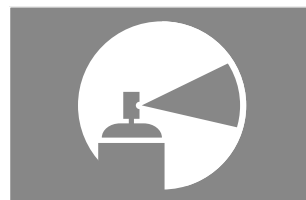

Graffiti protection



High strength



Easy installation



Innovative system technology



Low dead weight

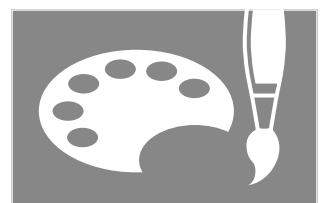

Large range of colours

# Rear-ventilated ceramic rainscreen facades

## Principle of the rear-ventilated rainscreen facade

The rear-ventilated rainscreen facade design is a highly effective system due to the physical separation of insulation and weather protection functions. Due to the space between the facade cladding and the insulation, air can circulate behind the facade cladding and remove any moisture. In terms of cost effectiveness, ecology and durability, the rear-ventilated rainscreen facade is growing in importance and is considered to be the leading system for new build constructions and building renovations.

This system can be used for all building types and heights and helps to reduce energy costs and fully complies with the requirements for energy-saving facades. Through the use of adequate insulation of thicknesses, the rear-ventilated facade can achieve the low-energy and passive house standards.

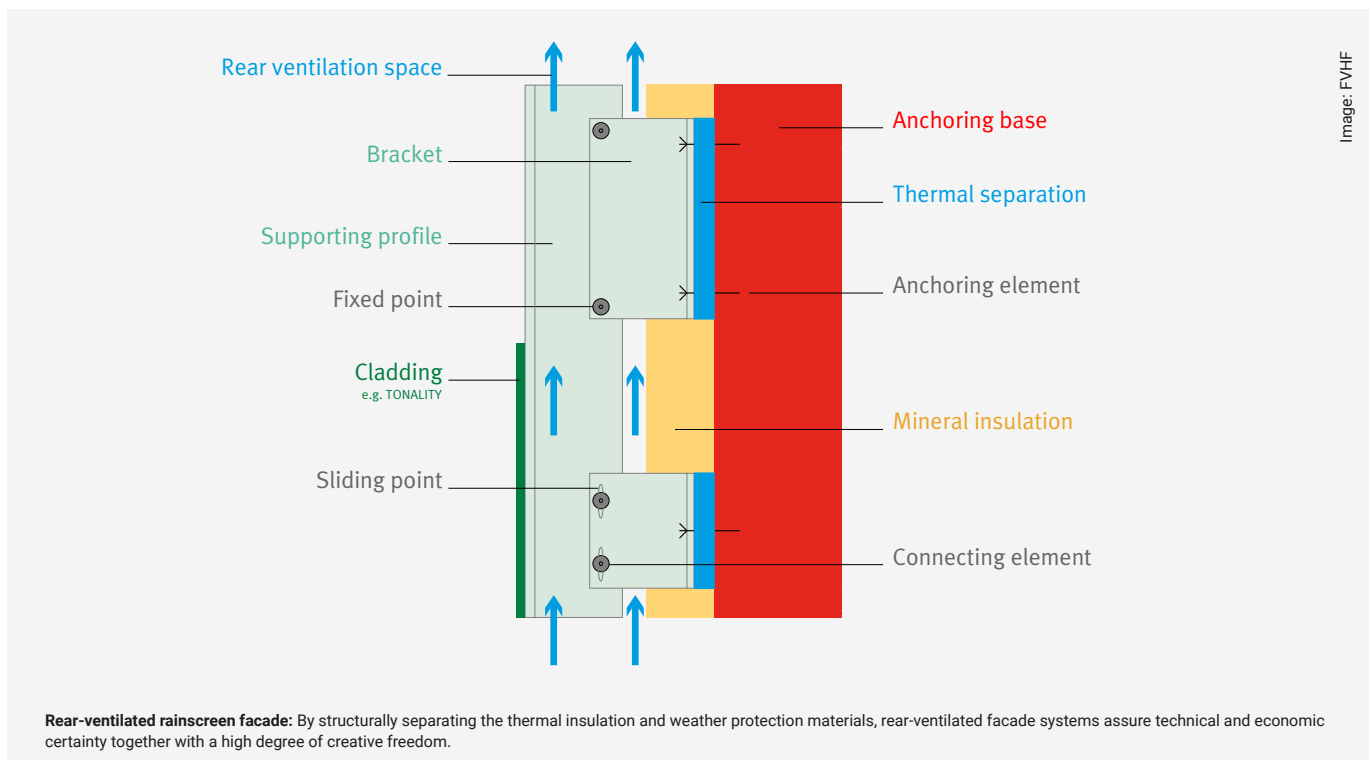

**Rear-ventilated rainscreen facade:** By structurally separating the thermal insulation and weather protection materials, rear-ventilated facade systems assure technical and economic certainty together with a high degree of creative freedom.

## TONALITY facade system

The TONALITY facade system consists of facade tiles that are profiled on the reverse and which interlock there with vertical aluminium hanger profiles. The vertical joints between the tiles are backed by aluminium joint profiles. TONALITY facade tiles can be used in indoor and outdoor areas with every building type and height. TONALITY facade tiles are also suitable for overhead (ceiling cladding) installation.

TONALITY facade tiles have been awarded technical approvals Z-10.3-796 for the 22 mm tile thickness and Z-10.3-798 for the 26 mm tile thickness.

The maximum spans for facade tiles in relation to the wind load can be obtained from the specific national technical approvals.

A distinction is made between the base clinch rail system (BAS) and the adaptive system (ADS), depending on the hanger profiles used.

## Manufacturing process

TONALITY facade tiles are produced, dried and fired in cutting-edge production facilities using the vacuum extrusion process. In the innovative KERALIS process, the raw clay material is dried, ground into a fine clay powder and coloured throughout in finely graduated mix ratios. The products are then fired at over 1,200°C. Due to the high quality of raw materials and high firing temperature, a sintering process occurs during firing. This produces the density and smooth surface.

## Areas of application

Rear-ventilated rainscreen facades. TONALITY facade tiles can be used in indoor and outdoor with every type and height of building. The TONALITY facade system has the national technical approval No. Z-10.3-798 in accordance with DIN 18516 from the Deutsches Institut für Bautechnik (DIBT). Privacy and sun protection is possible using TONALITY products.

## The clay material

The remarkable properties of clay have been known since ancient times. The discovery of clay ceramics made using the special plasticity of clay material dates from 10,000 - 8,000 BC. Thus, clay is among the oldest natural materials used by mankind. Clay materials are products of weathering and erosion of the earth's crust. They occur in continental and maritime areas. Their diversity is dependent on the physical-chemical conditions during their formation, which accounts for a wide spectrum of properties and thus the diverse possibilities for using clays. The first-class clays used for TONALITY are excavated in the Westerwald. They are among the world's finest clays and are famous for their special purity.

## Properties

- non-combustible / building material class A1 (EN 13501-1)
- weather-resistant and frost-resistant
- impermeable to water
- decay-proof
- UV resistant
- shock-proof
- permanent graffiti protection in the TONALITY NATUR, NUANCE, NOBLESSE COLOR and SIENA series
- governed by a national technical approval
- low system weight
- exact fit between tile and system substructure
- installation not affected by weather

# Base clinch rail system (BAS)

## BAS system

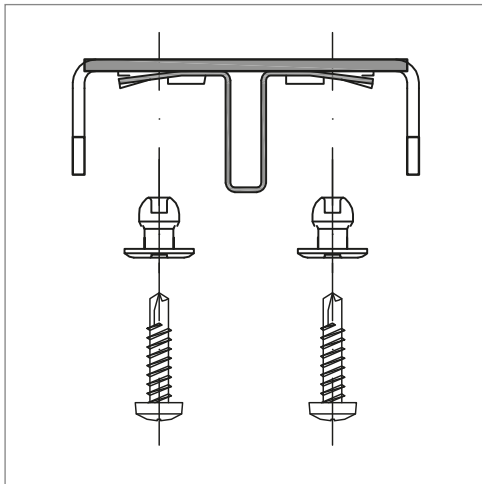

The base clinch rail system (BAS) can be attached to a conventional vertical primary substructure of wall brackets and T-profiles. Joint profiles and support profiles are already firmly connected to each other in the factory. The TONALITY 90° external corner profile is available for mitred corners and the TONALITY 30 x 30 mm external corner profile for open corners.

Reveal and lintel profiles are available for fixing in window and door areas. The system components are complemented by the universally applicable BAS-Flex holder.

Profile selection	Tile height (mm)	Profile length (mm)
Different system substructure profiles and profile lengths based upon the specific tile height resulting from the holder grid.	150	2,694
	175	2,794
	200	2,794
	225	2,694
	250	2,744
	300	2,694
	400	2,794



**BAS system on vertical substructure**

DWG No. BAS 200-01

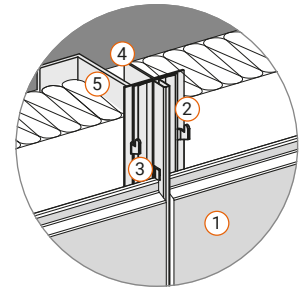
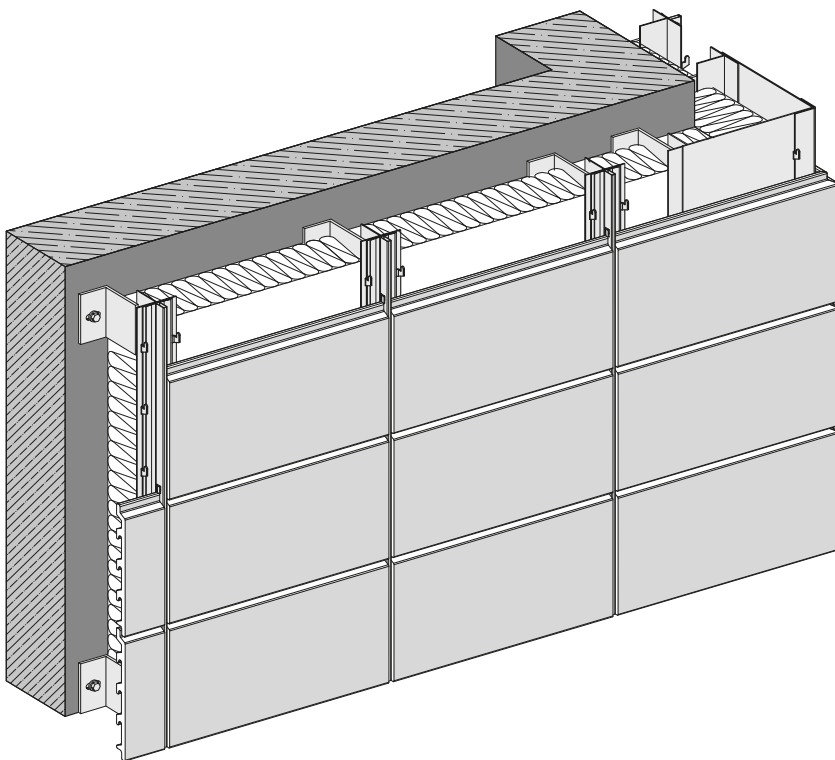

**Base clinch rail system (BAS)**

- 1 TONALITY facade tile
- 2 Base clinch rail system
- 3 Integrated deconstruction protection
- 4 Primary substructure aluminium T-profile (by installer)
- 5 Primary substructure metal wall bracket (by installer)

TONALITY system assemblies offer varied facade design options with a selection of joint profiles. Whether it is a closed 8 mm wide joint, an almost invisible 2 mm wide fine joint, or an open joint, the system has a solution for every design requirement. Closed joints can be implemented in both recessed and flush versions.

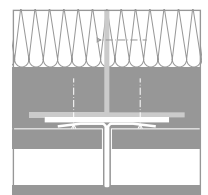
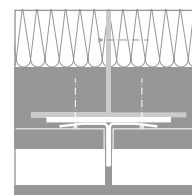
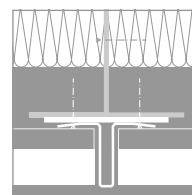
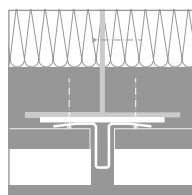
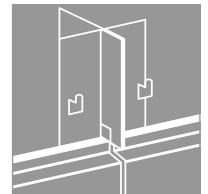
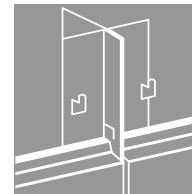
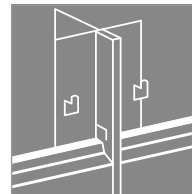
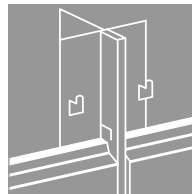

Closed joint profile  
recessed joint  
8 mm

Closed joint profile  
flush joint  
8 mm

Fine joint closed  
recessed joint  
2 mm

Fine joint closed  
flush joint  
2 mm

# Base clinch rail system (BAS)

## BAS system design and installation example

DWG No. BAS 200-02

DWG No. BAS 200-04/1

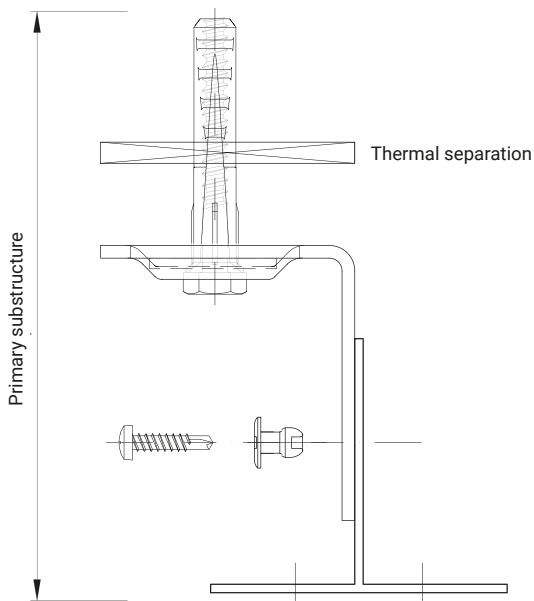

**Primary substructure**

Spacing, type of brackets, anchors, plugs or drill screws, in accordance with the specific structural calculations by the installer

Wall bracket and anchor by installer

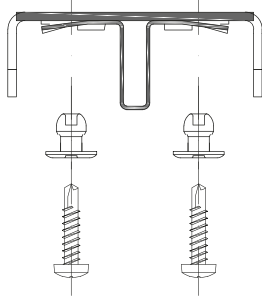

Aluminium T-profile  
by installer

System substructure  
BAS system

Rivet/drill screw by installer  
(in accordance with static  
engineering)

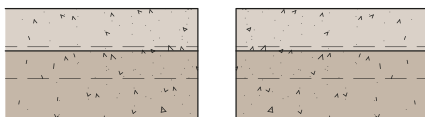

TONALITY Classic 26  
Facade tiles

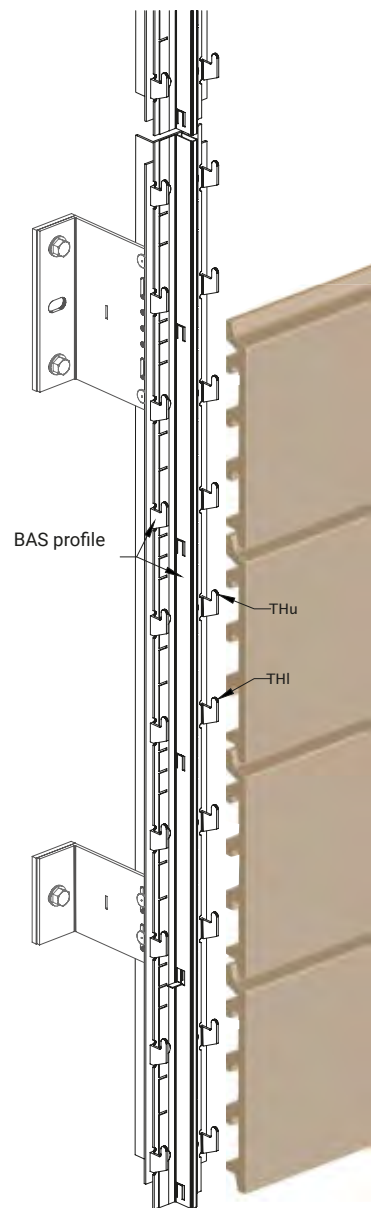

### Installation examples

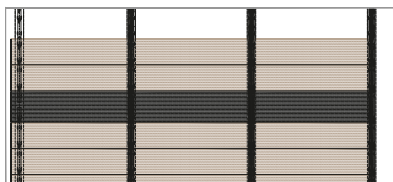
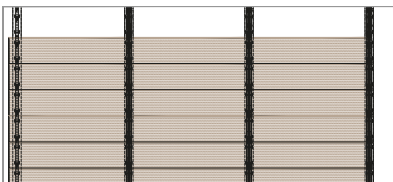

**BAS installation lay-out**

DWG No. BAS 200-05

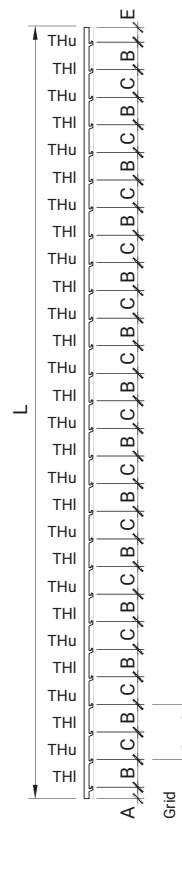
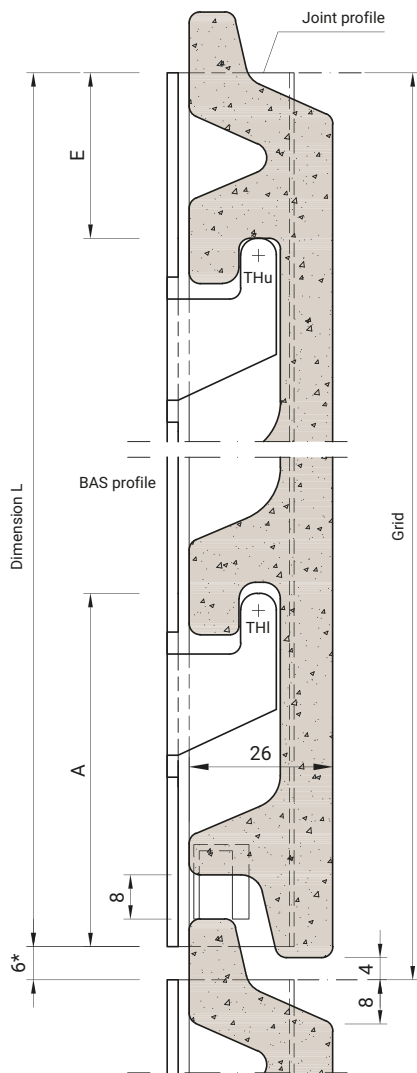

**Profile length= number of grid spaces minus 6 mm**

THu: Upper tile hanger  
THl: Lower tile hanger

\* The minimum butt joint spacing of tiles and profiles is 6 mm due to thermal linear expansivity (see approval).

Grid (mm)	Number of grid spaces	Dimension L (mm)	Dimension A (mm)	Dimension B (mm)	Dimension C (mm)	Dimension E (mm)
150	18	2,694	55	75	75	14
175	16	2,794	55	100	75	14
200	14	2,794	64	100	100	30
225	12	2,694	55	150	75	14
250	11	2,744	64	150	100	30
300	9	2,694	114	150	150	30
400	7	2,794	114	200	200	80

# Base clinch rail system (BAS)

## BAS delivery programme

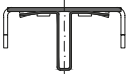



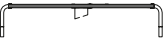

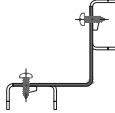



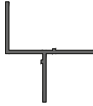

Image	Designation	Material/colour
DWG No. dwg 780 	BAS profile 20 x 60 x 20 mm System depth 31 mm Closed joint 8 x 21 mm	aluminium bright; joint profile RAL 7021 black-grey
DWG No. dwg 781 	BAS profile 20 x 60 x 20 mm System depth 31 mm Closed joint 8 x 29 mm	aluminium bright; joint profile RAL 7021 black-grey
DWG No. dwg 782 	BAS profile 20 x 60 x 20 mm System depth 31 mm Closed joint 2 x 21 mm	aluminium bright; joint profile RAL 7021 black-grey
DWG No. dwg 783 	BAS profile 20 x 60 x 20 mm System depth 31 mm Closed joint 2 x 29 mm	aluminium bright; joint profile RAL 7021 black-grey
DWG No. dwg 789 	BAS end profile 20 x 40 x 23 mm	aluminium bright
DWG No. dwg 723 	BAS reveal/lintel profile 20 x 100 x 20 mm	aluminium bright
DWG No. dwg 784/785 	BAS closure profile 23 x 40 x 20 mm left or 20 x 40 x 23 mm for right	aluminium bright

Image	Designation	Material/colour
DWG No. dwg 724 	Reveal clip 90° external corner 20 x 66 x 66 x 20 mm	aluminium bright
DWG No. dwg 787 	External corner profile 90° 20 x 40 x 40 x 20 mm System depth 31 mm	aluminium bright
DWG No. dwg all-16 	Sealing carrier profile for external corner 27 x 64 mm (usable on both sides)	aluminium bright
DWG No. dwg 206 	Joint profile for corner, closure joints and wind barrier	CR neoprene black
DWG No. dwg all-02 	External corner profile visible 30 x 30 mm	aluminium bright
DWG No. dwg all-16 	Spacer for horizontal joint with cut tile	aluminium bright

The substructure shown on this page is suitable for a tile thickness of 26 mm. An analogous substructure is available for a tile thickness of 22 mm. Note: Permitted spans and design calculation values (static engineering) see pages 48/49.

# BAS-Flex holder

## BAS-Flex system design and installation example

DWG No. BAS 200-51

DWG No. BAS 200-50

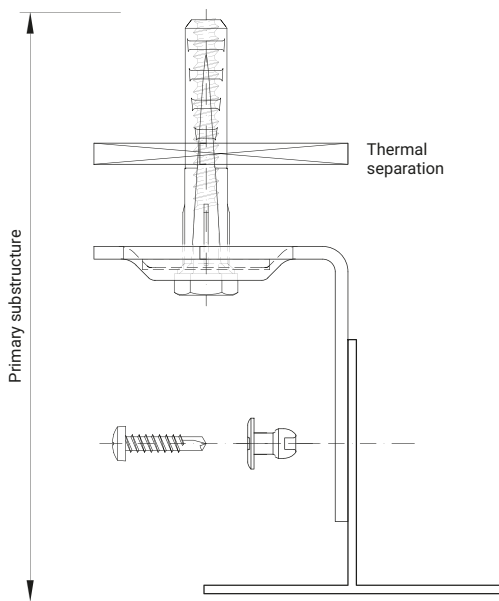

**Primary substructure**  
Spacing, type of brackets, anchors and dowel plugs in accordance with the specific structural calculations for the building by the installer

Wall bracket and anchor by installer

Aluminium T profile by installer

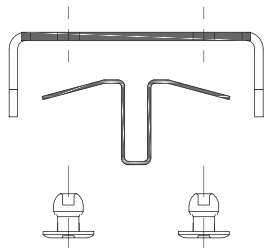

System substructure  
BAS-Flex holder  
with Flex joint profile

Blind rivet  
by installer  
(in accordance with structural calculations)

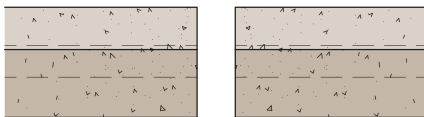

TONALITY Classic 26  
Facade tile

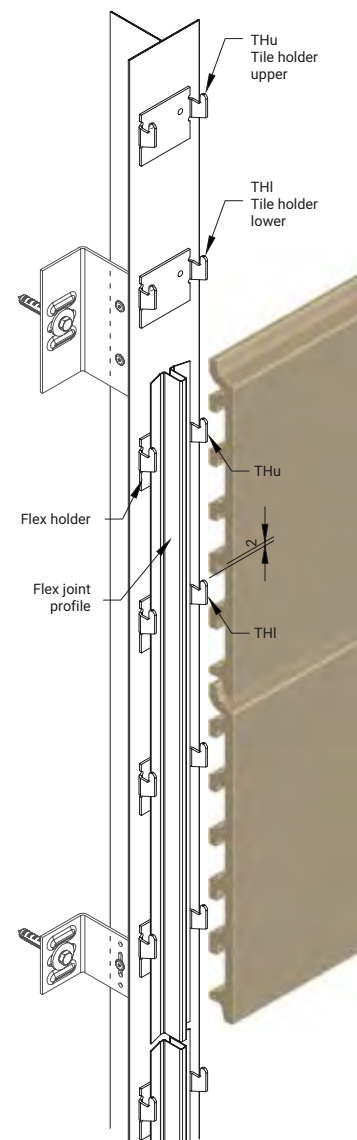

### Installation examples

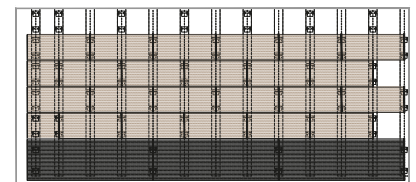
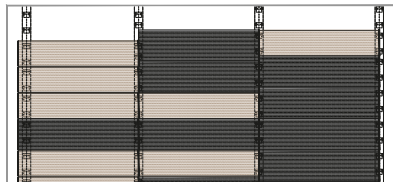
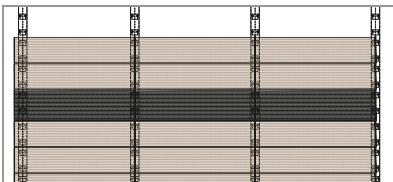



## BAS-Flex delivery programme

The BAS-Flex holder serves as a supplement to the BAS system components. It facilitates easy implementation of mixed grids and height offsets, and can be used universally with all grids and tile heights.

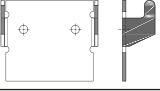

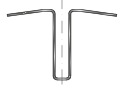







Image	Designation	Material/colour
DWG No. dwg 791 	BAS-Flex holder 20 x 60 x 50 mm System depth 31 mm	Finish bright
DWG No. dwg 792 	BAS-Flex joint profile closed (8 x 21 mm)	Finish coated RAL 7021 black-grey
DWG No. dwg 793 	BAS-Flex joint profile closed (8 x 29 mm) flush	Finish coated RAL 7021 black-grey
DWG No. dwg 795 	BAS-Flex fine joint profile (2 x 21 mm)	Finish coated RAL 7021 black-grey
DWG No. dwg 796 	BAS-Flex fine joint profile (2 x 29 mm) flush	Finish coated RAL 7021 black-grey
DWG No. dwg 794 	BAS-Flex spring end strip (45 mm)	Finish bright

Image	Designation	Material/colour
DWG No. dwg all-06 	Sealing carrier profile for external corner 27 x 24 mm (usable on both sides)	aluminium bright
DWG No. dwg 206 	Joint profile for corner, closure joints and wind barrier	CR neoprene black
DWG No. dwg all-02 	External corner profile visible 30 x 30 mm	aluminium bright
DWG No. dwg all-16 	TONALITY spacer for horizontal joint at fitted tile	aluminium bright
DWG No. dwg 798 	BAS-Flex Drilling jig 60 x 1,385 mm	Finish bright

The substructure shown on this page is suitable for a tile thickness of 26 mm.

An analogous substructure is available for a tile thickness of 22 mm.

Note: Permitted spans and design calculation values (static engineering)  
see pages 48/49.

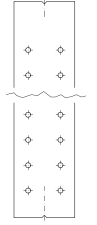
# BAS standard details

## Representation of joint profiles

DWG No. BAS 200-07

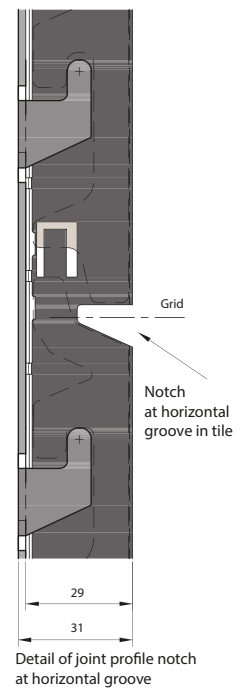
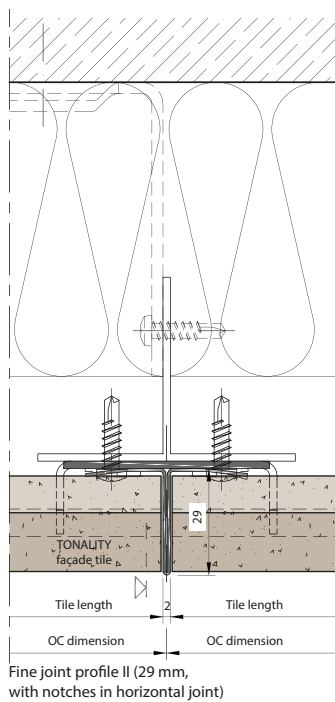
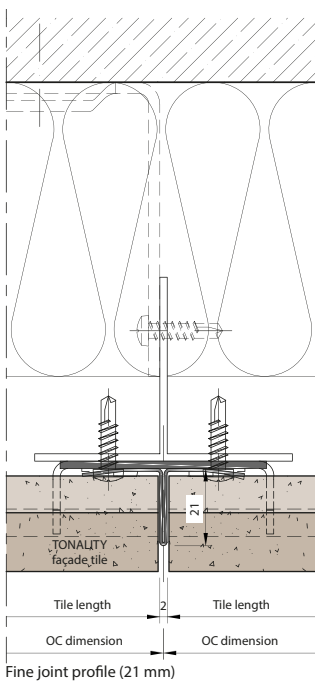
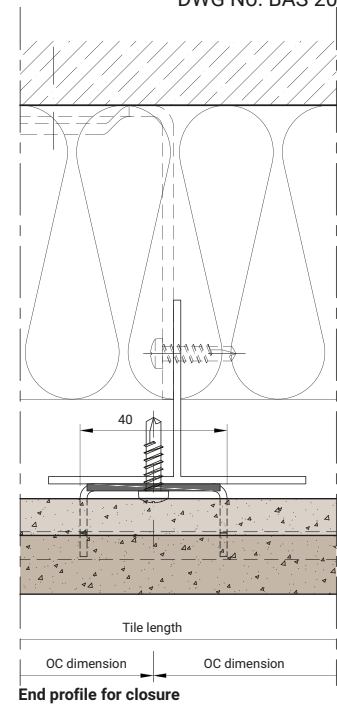
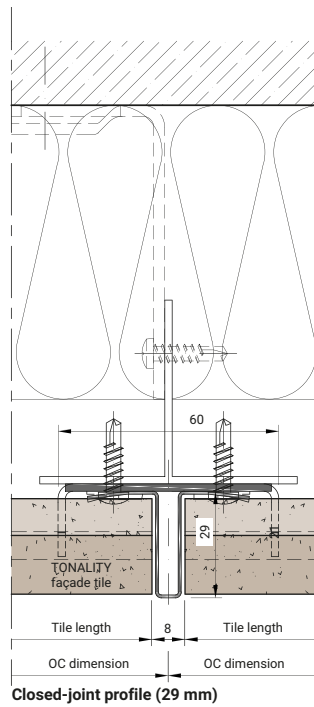
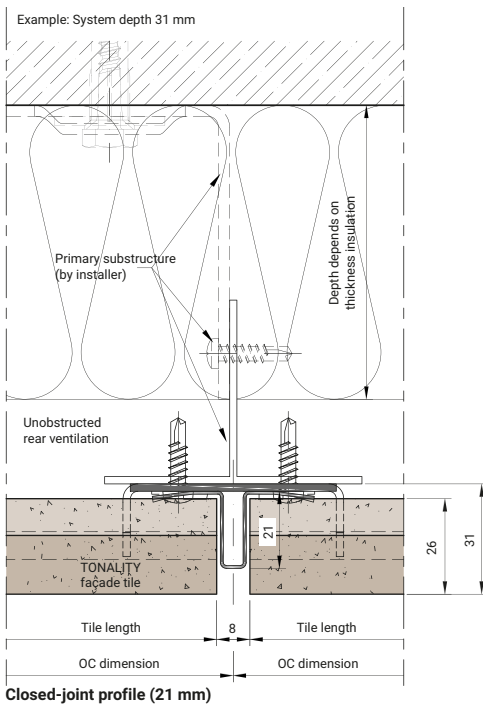



### Vertical section of parapet

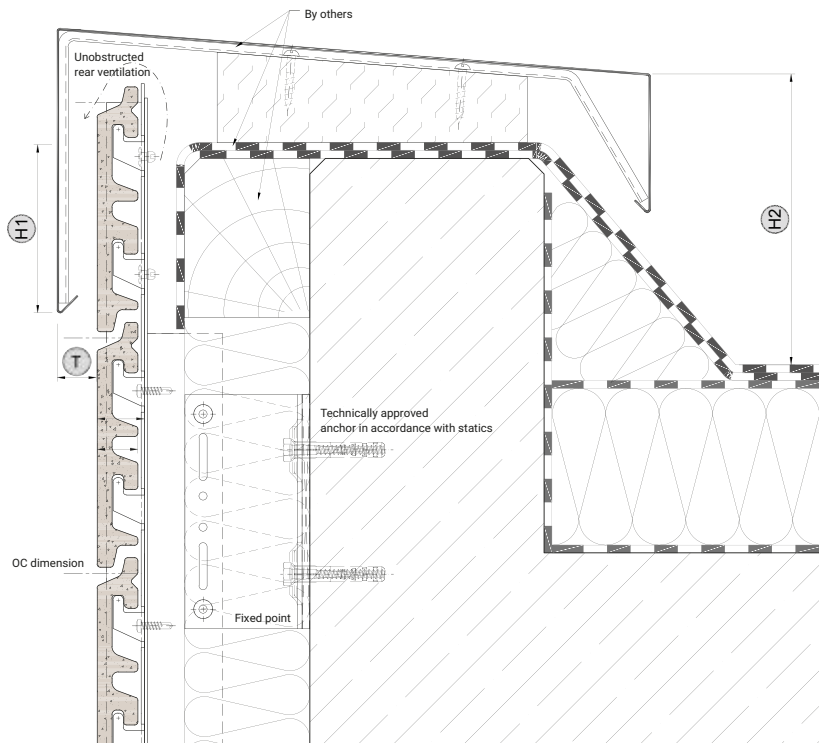

DWG No. BAS 100-20

#### Flat roof guideline requirements

- H1** The outer, vertical leg of covers or copings must overlap the upper edge of render or cladding.
- Building height:
 

up to 8 m:	min. 50 mm
over 8 to 20 m:	min. 80 mm
over 20 m:	min. 100 mm
- H2** The roof edge closure height must be as follows:
 

Roof pitches up to 5° approx.	100 mm
Roof pitches > 5° approx.	50 mm

 above the covering surface or gravel layer.  
 Roof edge closures must slope toward the roof.
- T** The overhang of covers or copings must have a drip edge, at least 20 mm away from the protected building elements.

### Vertical section of base

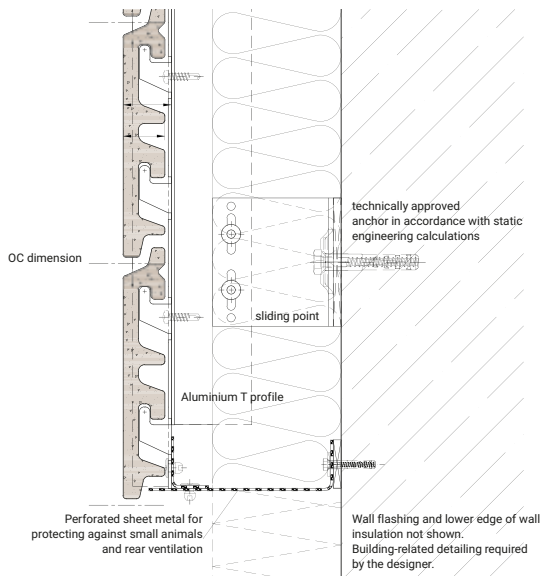

DWG No. BAS 100-21

# BAS standard details

## Vertical window sections

DWG No. BAS 200-15

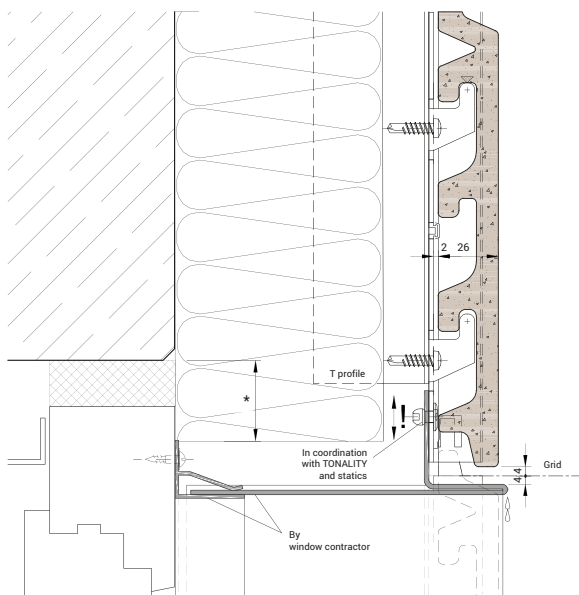

Window lintel with sheet metal cladding (without sun protection)

DWG No. BAS 200-17

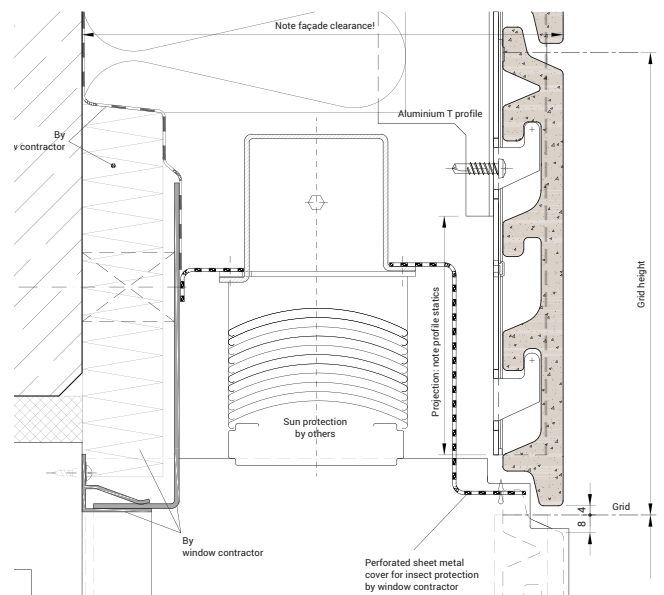

Window lintel with sun protection

DWG No. BAS 200-16

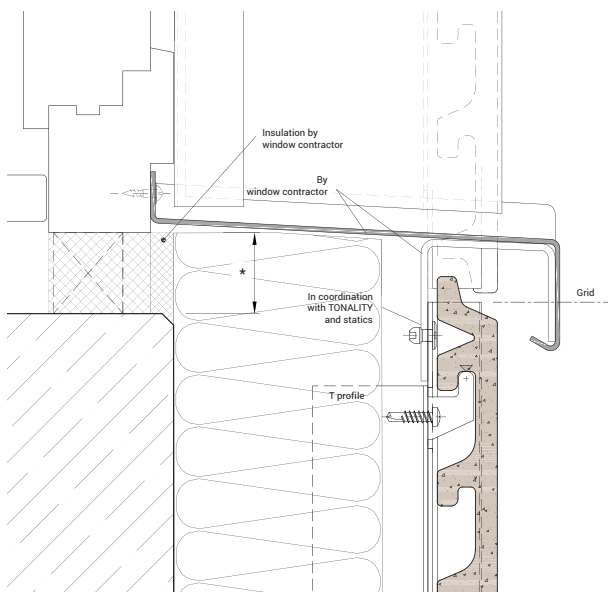

Parapet with window sill connection

DWG No. BAS 200-15.1

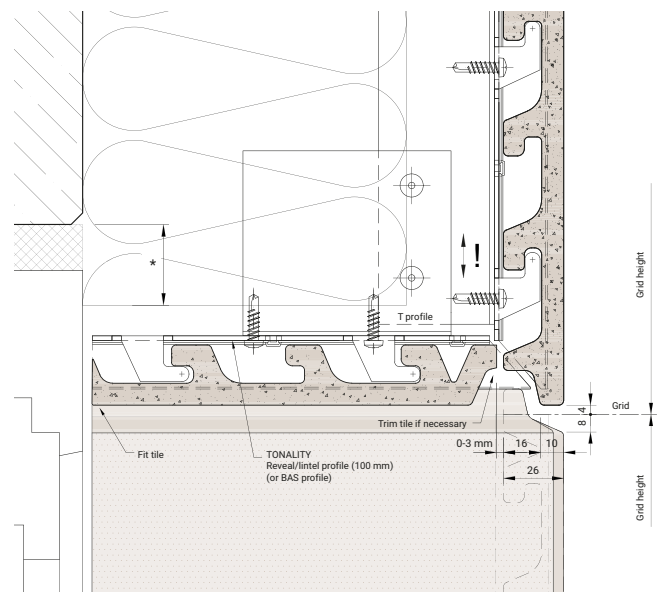

Window lintel with TONALITY cladding (without sun protection)

\* Insulation must be implemented in accordance with the current Energy Saving Ordinance (EnEV).

## Horizontal window sections

DWG No. BAS 200-14

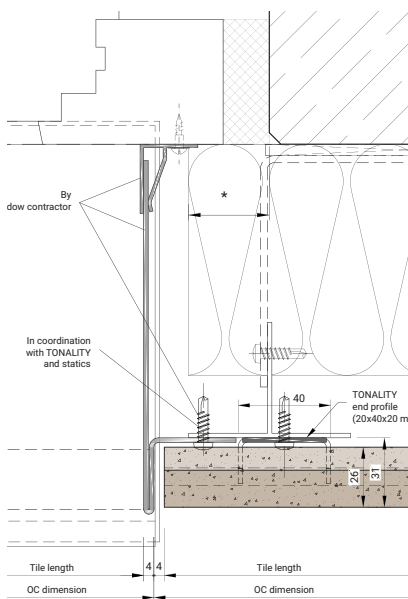

Window reveal with sheet metal cladding

DWG No. BAS 200-14.3

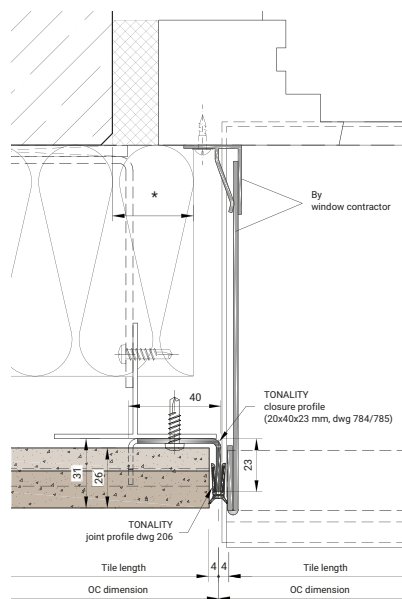

Window reveal with sheet metal cladding and neoprene joint seal

DWG No. BAS 200-30

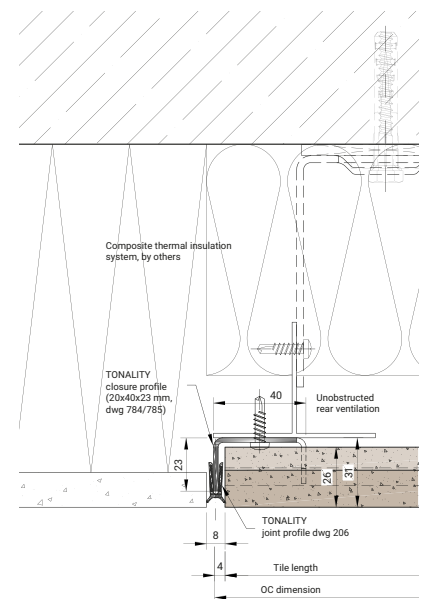

Transition from TONALITY facade (RVCF) to ETICS with neoprene joint seal

DWG No. BAS 200-14.2

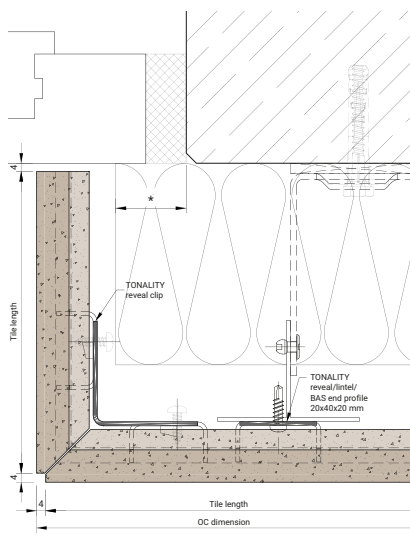

Window reveal with TONALITY (small)

DWG No. BAS 200-14.2

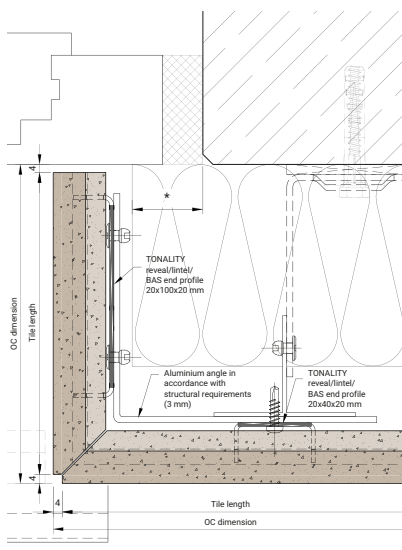

Window reveal with TONALITY (large)

DWG No. BAS 200-14.1

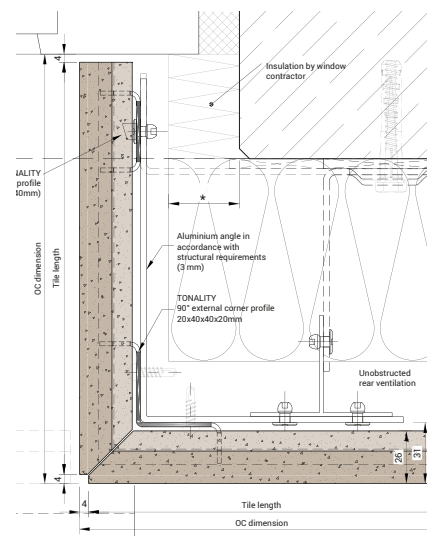

\* Insulation must be implemented in accordance with the current Energy Saving Ordinance (EnEV).

# BAS standard details

## Horizontal sections of external corners

DWG No. BAS 200-09

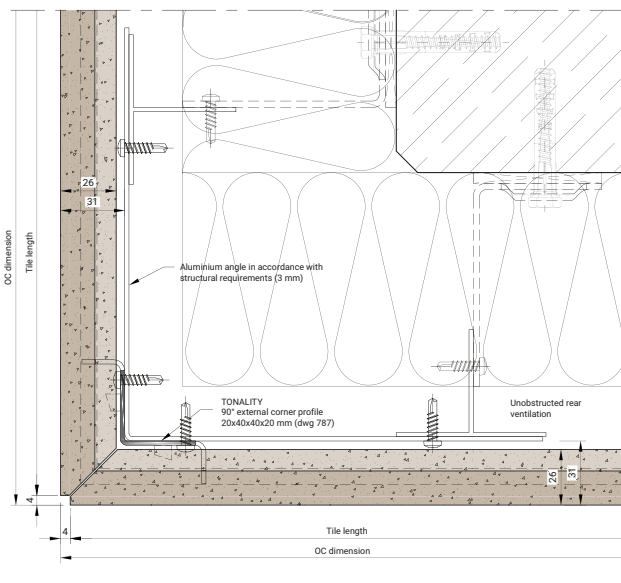

External corner 90° – TONALITY on vertical primary substructure, mitred TONALITY – external corner profile 90° 20 x 40 x 40 x 20 mm. The edges of mitre cuts must always be provided with a 4 mm chamfer. For example, the external corner profile can be attached to an aluminium sheet.

DWG No. BAS 200-10

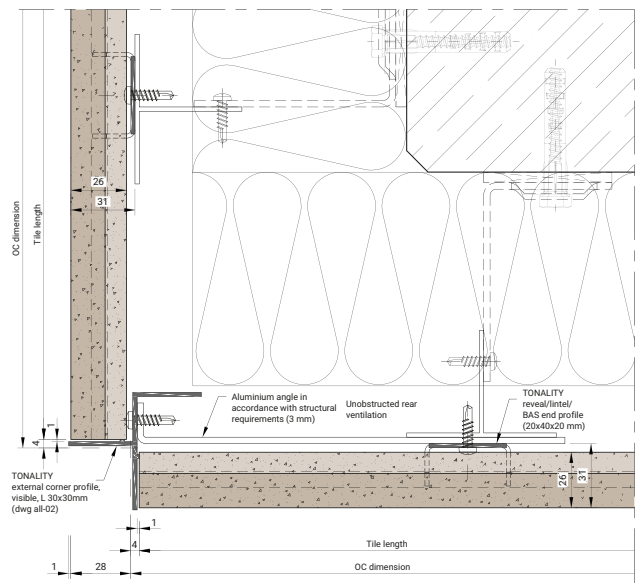

External corner 90° – TONALITY on vertical primary substructure, TONALITY with corner profile – visible external corner profile 30 x 30 mm.

## Horizontal sections of internal corners

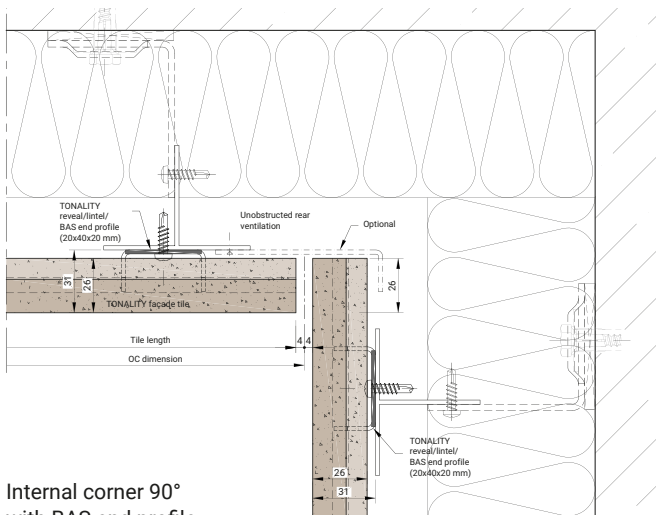

Internal corner 90° with BAS end profile  
All drawings show tiles with a thickness of 26 mm

DWG No. BAS 200-11

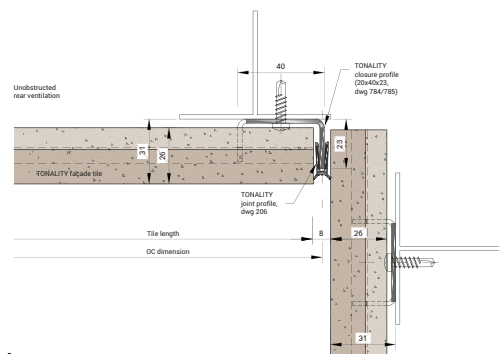

**Optional:**  
Internal corner 90° with BAS closure and joint profile (neoprene, black)

### Horizontal section of external corner with wind barrier

DWG No. BAS 200-08

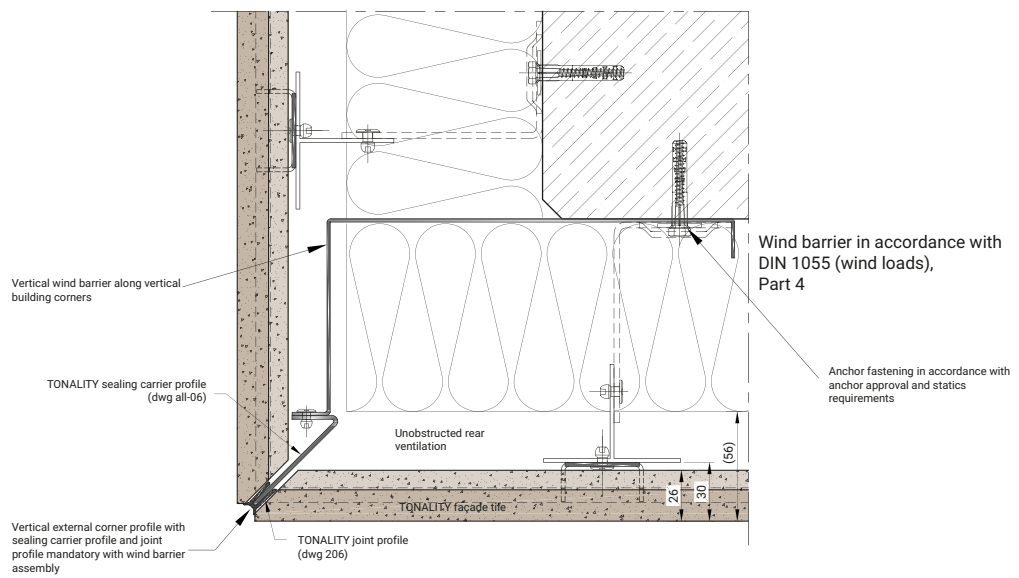

## BAS – installation of cut tiles

### Cut tiles with spacer

DWG No. dwg all-16

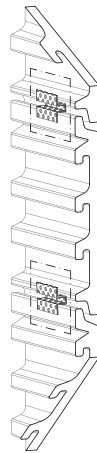
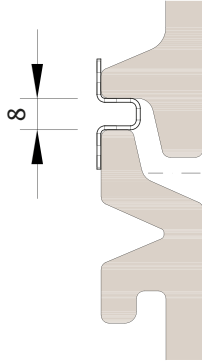

### Installation instructions

1. Mark the cut tile.
2. Cut with wet saw and recommended cutting blade.
3. Place cut tile face down on a flat substrate.
4. Set up the required tile spacing using a system substructure profile with hangers spaced in accordance with grid.
5. Place the spacers in position (two pieces per cut tile).
6. Fill the resulting joint with spacer adhesive, spread smoothly and evenly and allow to set.
7. Hang the facade tile with scheduled cutting mark on the system substructure profile.

### Installation with spacer – vertical section of window lintel

DWG No. BAS 200-15

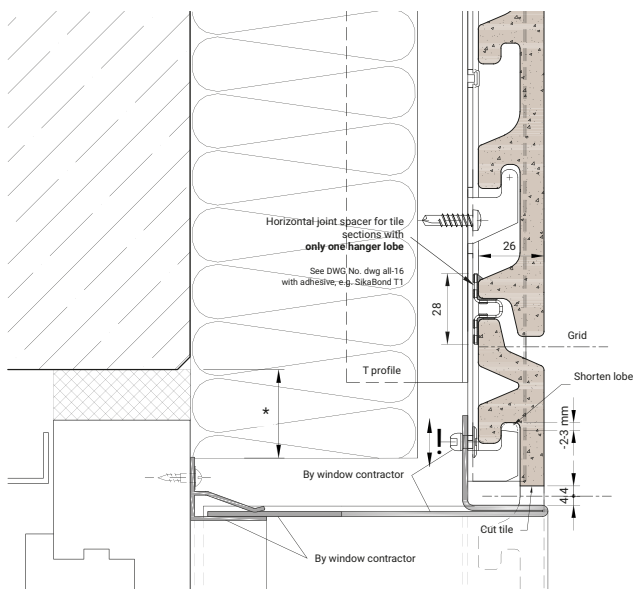

Detail of cut tile fastening above the window

### Installation with spacer – vertical section of window spandrel

DWG No. BAS 200-16

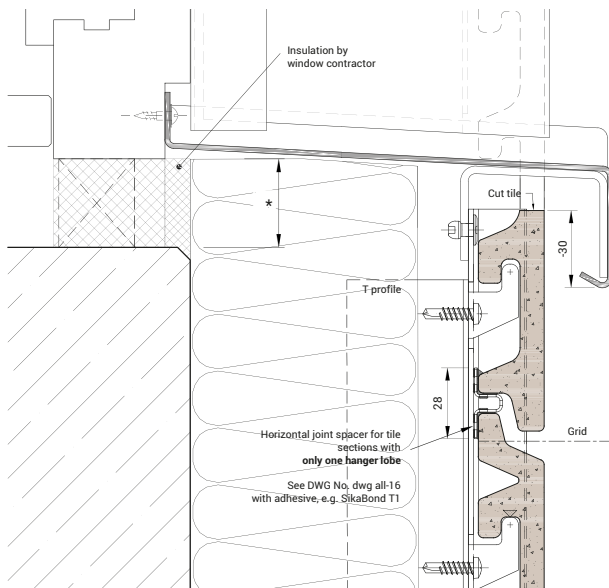

Detail of cut tile fastening below the window

# BAS on wooden primary substructure

## BAS on wooden primary substructure

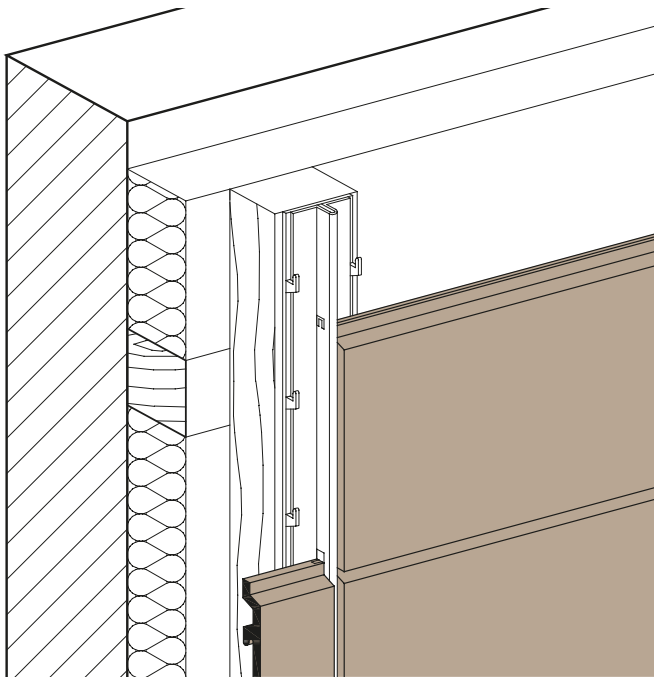

The details must be adapted to the material of the specific substructure selected.

### BAS system design



1 Wood primary substructure

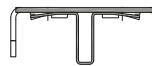

2 BAS profile



3 Wood screw

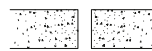

4 TONALITY facade tile



# BAS portrait installation

## Portrait installation

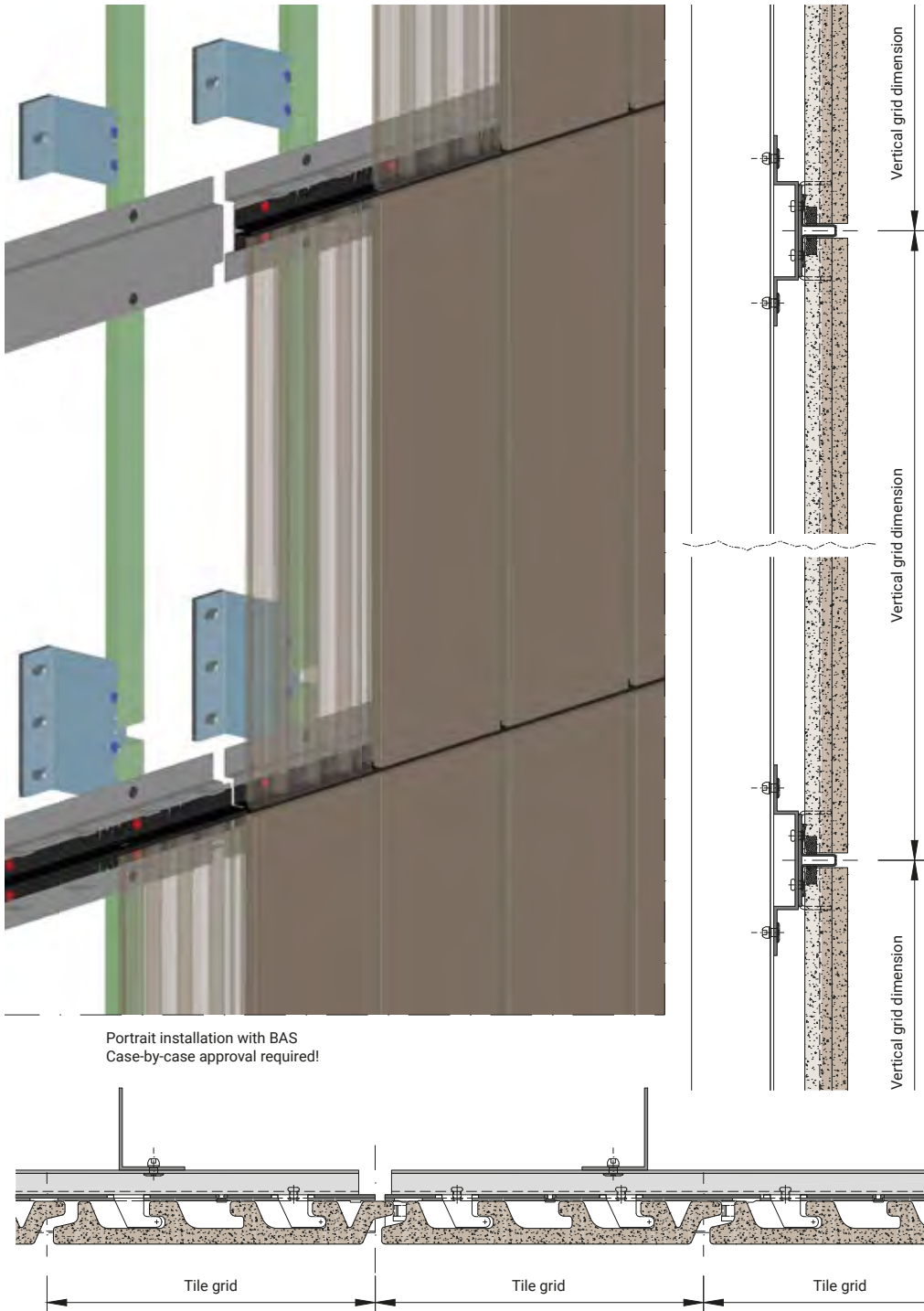



# Adaptive system (ADS)

## ADS on horizontal or vertical metal substructure

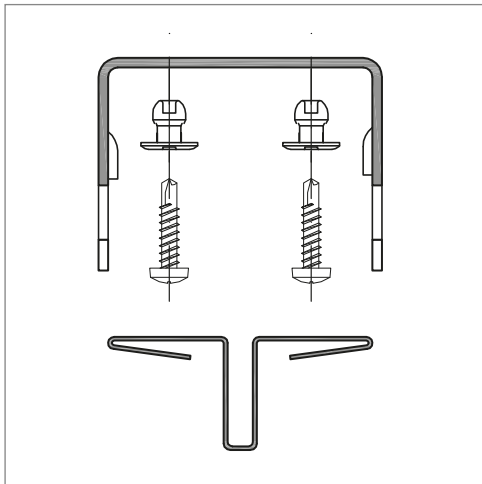

TONALITY adaptive vertical profiles accept joint profiles with closed, fine or open joints or end profiles without joints. Left and right-hand external corner profiles are available for mitred corners with 3 system depths: 46, 56 and 66 mm. The TONALITY 30 x 30 mm external corner profile is used for open corners with profiles of 56 and 66 mm system depth. The TONALITY support profile prevents noise being generated in the hanger bracket.

Reveal and lintel profiles are available for fixing in window and door areas. TONALITY gable clips are used with special adhesive to attach tiles cut at an angle.

Profile selection	Tile height (mm)	Profile length (mm)
Different system substructure profiles and profile lengths based upon the specific tile height result from the hanger grid.	150	2,694
	175	2,794
	200	2,794
	225	2,694
	250	2,744
	300	2,694
	400	2,794

# Adaptive system (ADS)

## Adaptive system (ADS) on horizontal substructure

DWG No. ADS 100-01h

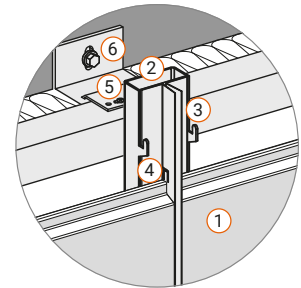
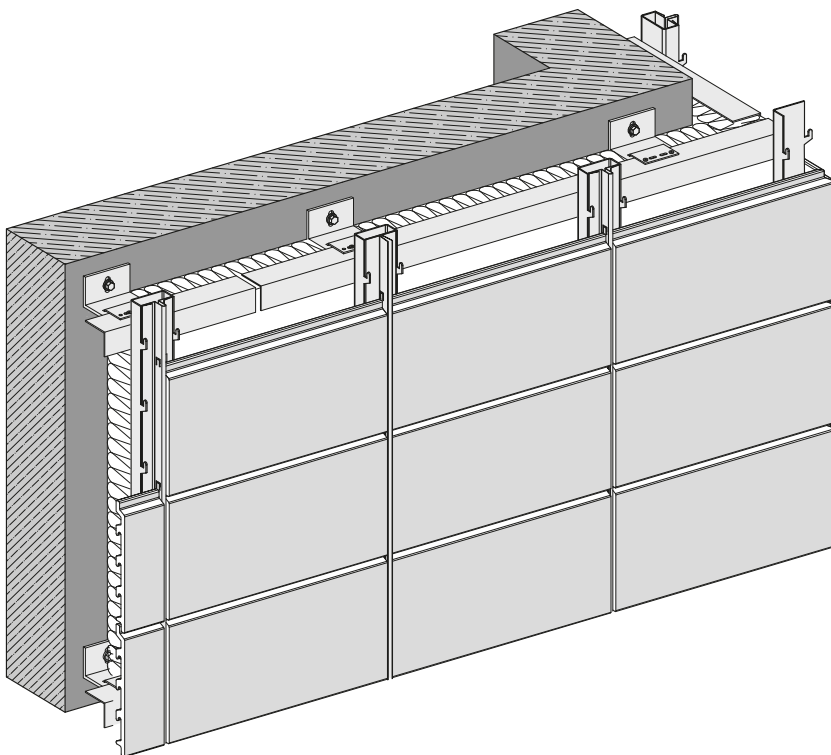

### Adaptive system ADS

- 1 TONALITY facade tile
- 2 TONALITY Adaptive vertical profile metal (= system substructure)
- 3 TONALITY Adaptive metal joint profile
- 4 TONALITY integrated deconstruction protection
- 5 Primary substructure aluminium T-profile (by installer)
- 6 Primary substructure metal wall bracket (by installer)

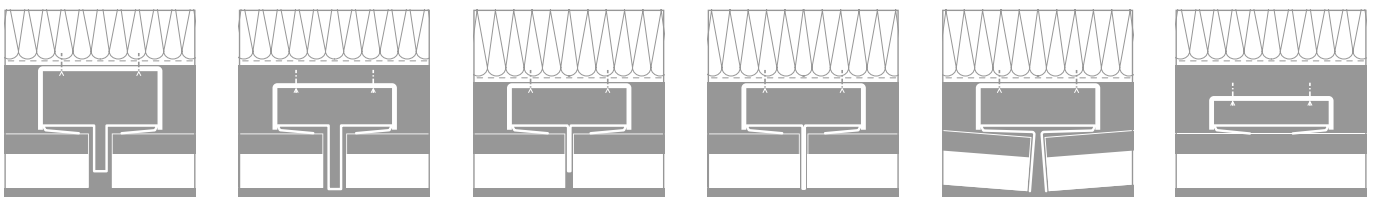
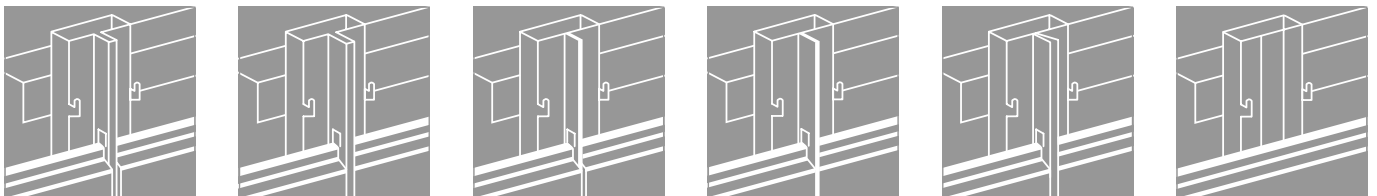

Closed joint profile  
recessed joint  
8 mm

Closed joint profile  
flush joint  
8 mm

Fine joint closed  
recessed joint  
2 mm

Fine joint closed  
flush joint  
2 mm

Open joint profile  
joint  
8 mm

End profile for closure  
No disassembly protection

### Adaptive system (ADS) on vertical substructure

DWG No. ADS 100-01v

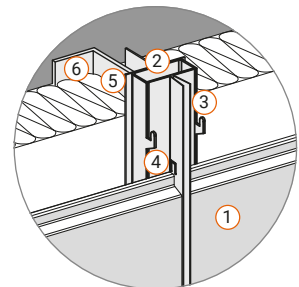
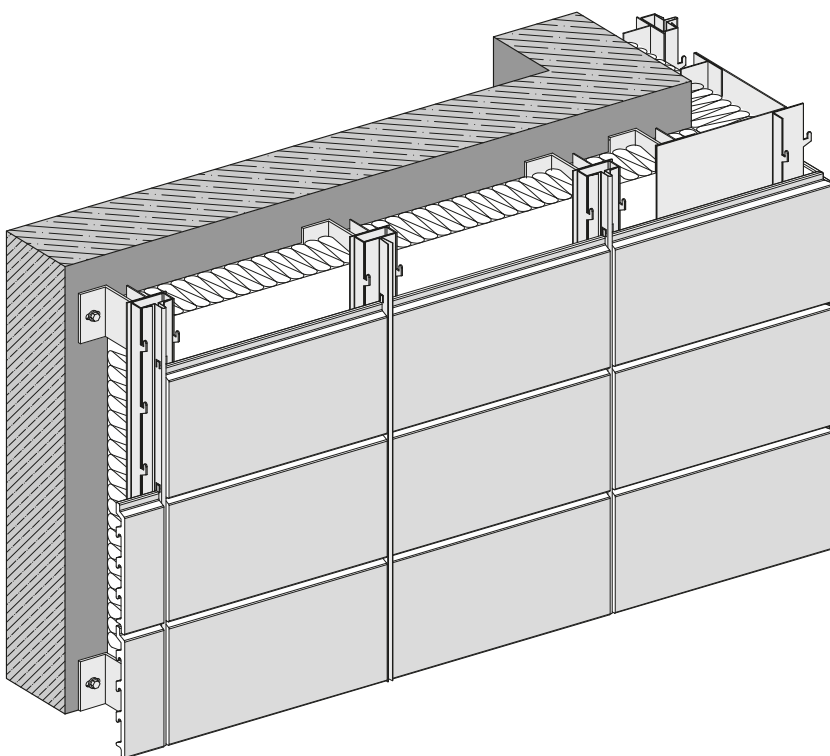

#### Adaptive system ADS

- 1 TONALITY facade tile
- 2 TONALITY Adaptive vertical profile metal (= system substructure)
- 3 TONALITY Adaptive metal joint profile
- 4 TONALITY integrated deconstruction protection
- 5 Primary substructure aluminium T-profile (by installer)
- 6 Primary substructure metal Wall bracket (by installer)

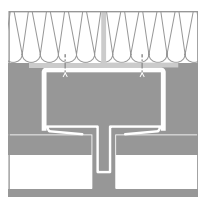
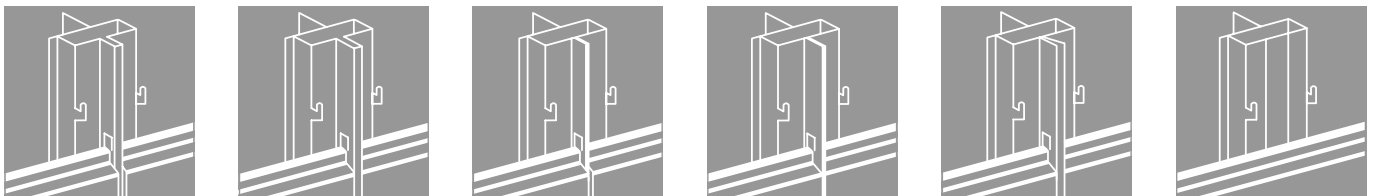

Closed joint profile  
recessed joint  
8 mm

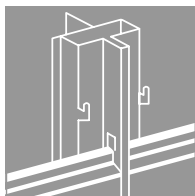

Closed joint profile flush joint  
8 mm

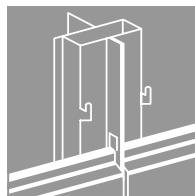

Fine joint closed  
recessed joint  
2 mm

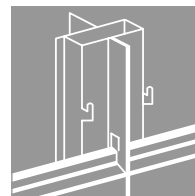

Fine joint closed  
flush joint  
2 mm

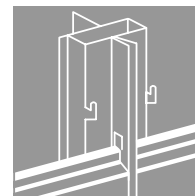

Open joint profile  
joint  
8 mm

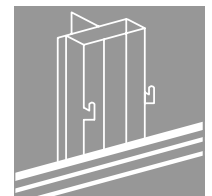

End profile for closure  
No disassembly protection

# Adaptive system (ADS)

## ADS on horizontal substructure – system design and installation example

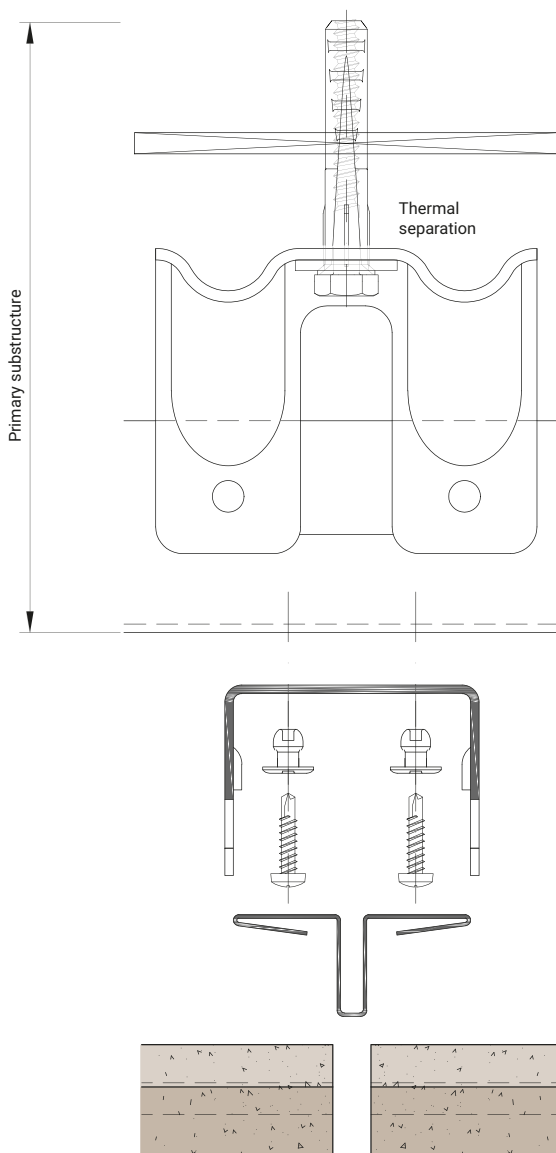

DWG No. ADS 100-02h

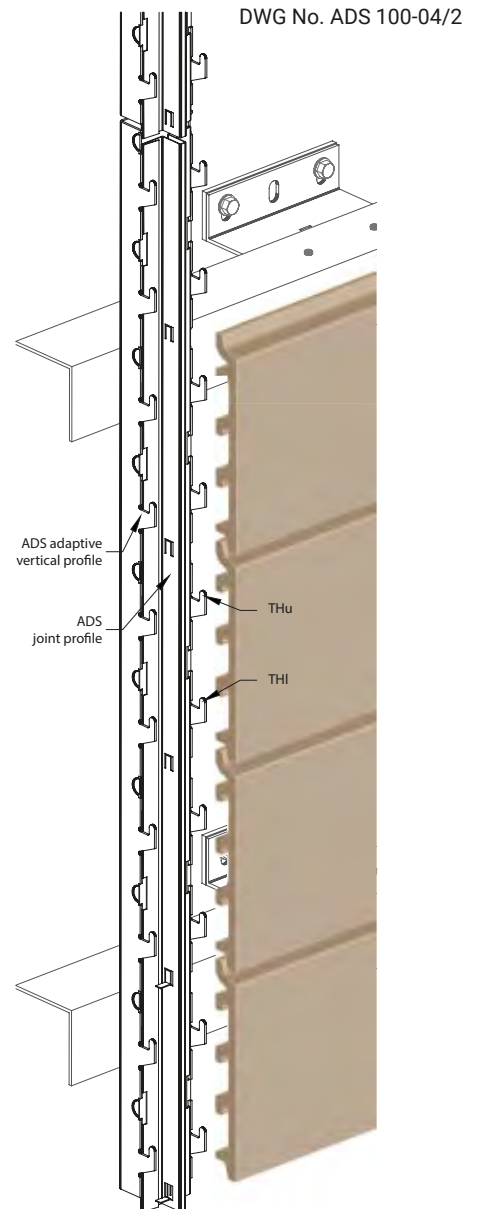

DWG No. ADS 100-04/2

### Installation examples

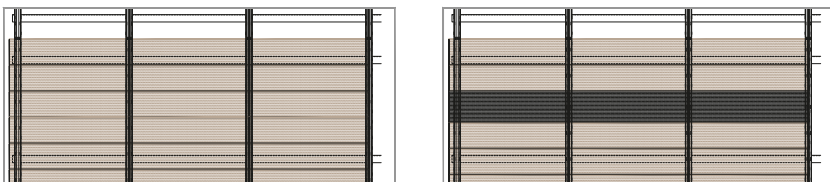

## ADS on vertical substructure – system design and installation example

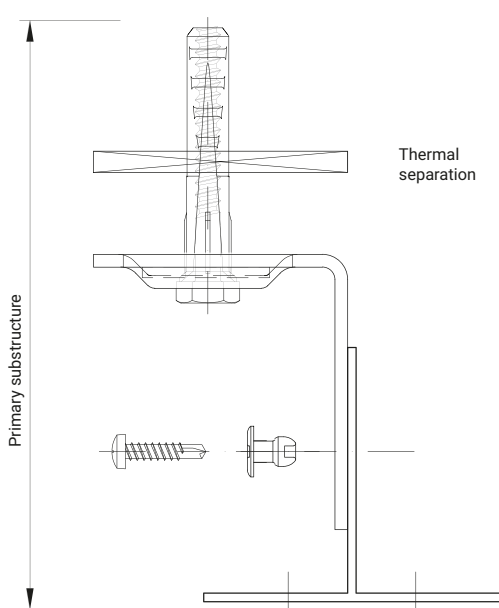

Thermal separation

DWG No. ADS 100-02v

**Primary substructure**  
Spacing, type of brackets, anchors and plugs in accordance with property-specific structural calculations! by installer

Wall bracket and anchor by installer

Aluminium T profile by installer

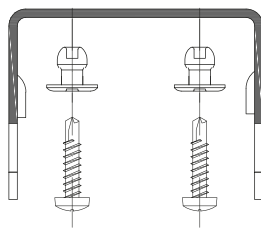

System substructure  
TONALITY adaptive vertical profile

Rivet/drill screw by installer (in accordance with statics calculation)



TONALITY adaptive joint profile

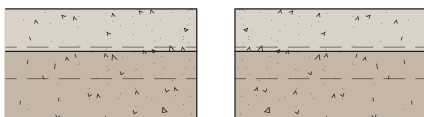

TONALITY façade tile

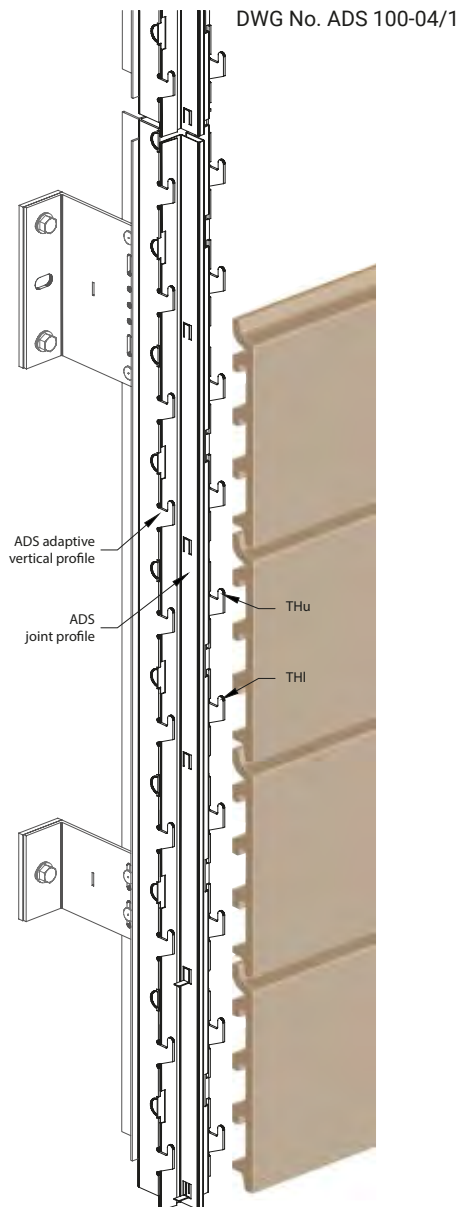

DWG No. ADS 100-04/1

### Installation examples

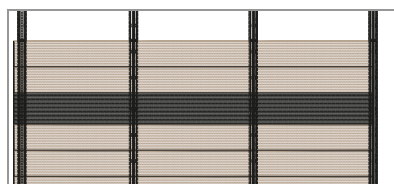

# Adaptive system (ADS)

## ADS installation lay-out

DWG No. ADS 100-05

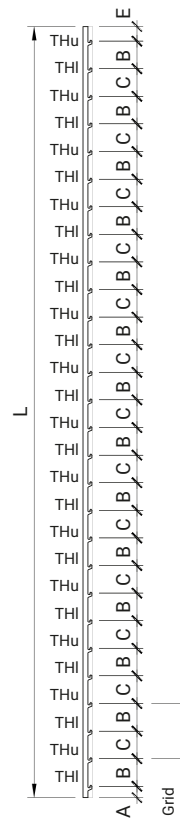
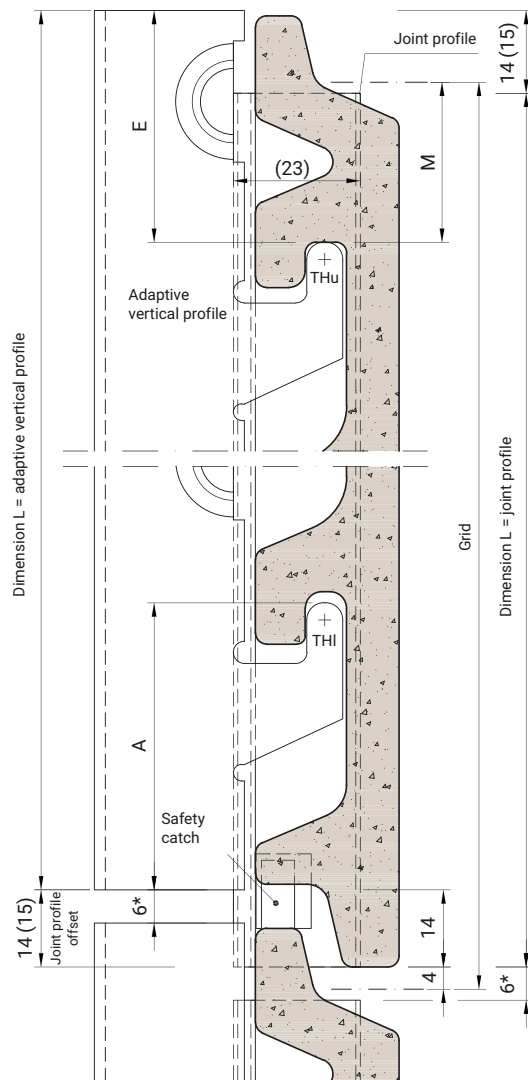

\* The minimum butt joint spacing of tiles and profiles is 6 mm due to linear thermal expansion (see approval).

Grid (mm)	Number of grid spaces	Dimension L (mm)	Dimension A (mm)	Dimension B (mm)	Dimension C (mm)	Dimension E (mm)	Dimension M (mm)
150	18	2,694	43	75	75	26	14
175	16	2,794	43	100	75	26	14
200	14	2,794	52	100	100	42	30
225	12	2,694	43	150	75	26	14
250	11	2,744	52	150	100	42	30
300	9	2,694	102	150	150	42	30
400	7	2,794	102	200	200	92	80

The substructure shown on this page is suitable for a tile thickness of 26 mm. An analogous substructure for a tile thickness of 22 mm is available. Note: Permitted spans and calculation values (static engineering) see pages 48/49.



## ADS delivery programme



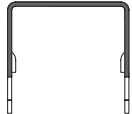











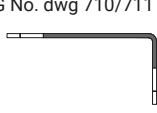
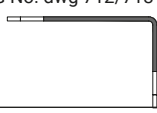
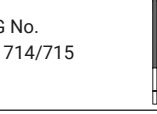



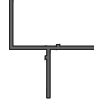

Image	Designation	Material/colour
DWG No. dwg 701 	Adaptive vertical profile 46 35 x 60 x 35 mm for system depth 46 mm	aluminium bright
DWG No. dwg 702 	Adaptive vertical profile 56 45 x 60 x 45 mm for system depth 56 mm	aluminium bright
DWG No. dwg 703 	Adaptive vertical profile 66 55 x 60 x 55 mm for system depth 66 mm	aluminium bright
DWG No. dwg 704 	Closed joint profile (8 mm) 56 x 23 mm for all system depths	aluminium RAL 7021 (black-grey)
DWG No. dwg 706 	Closed joint profile (8 mm) 56 x 30 mm, flush for all system depths	aluminium RAL 7021 (black-grey)
DWG No. dwg 707 	Joint profile fine joint (2 mm) 56 x 23 mm for all system depths	aluminium RAL 7021 (black-grey)
DWG No. dwg 708 	Joint profile fine joint (2 mm) 56 x 30 mm, flush for all system depths	aluminium RAL 7021 (black-grey)
DWG No. dwg 709 	Joint profile (8 mm) open 56 x 32 mm, flush for all system depths	aluminium RAL 7021 (black-grey)
DWG No. dwg all-01 	End profile for closure 56 x 5 mm for all system depths	aluminium bright
DWG No. dwg 789 	Reveal/lintel profile narrow, profile width 40 mm for all system depths	aluminium bright
DWG No. dwg 723 	Reveal/lintel profile wide, profile width 100 mm for all system depths	aluminium bright

Image	Designation	Material/colour
DWG No. dwg 716/717 	Closure profile 35 x 30 x 37 mm for right or 37 x 30 x 35 mm for left, for system depth 46 mm	aluminium bright
DWG No. dwg 718/719 	Closure profile 45 x 30 x 47 mm for right or 47 x 30 x 45 mm for left, for system depth 56 mm	aluminium bright
DWG No. dwg 720/721 	Closure profile 55 x 30 x 57 mm for right or 57 x 30 x 55 mm for left, for system depth 66 mm	aluminium bright
DWG No. dwg 710/711 	Vertical profile external corner for system depths 46 mm, 74/35 mm, available in both right and left versions	aluminium bright
DWG No. dwg 712/713 	Vertical profile external corner for system depths 56 mm, 74 x 45 mm, available in both right and left versions	aluminium bright
DWG No. dwg 714/715 	Vertical profile external corner for system depths 66 mm, 74/55 mm, usable on both sides	aluminium bright
DWG No. dwg 207 	Support profile 60 mm (short piece) for all system depths and grids	CR neoprene black
DWG No. dwg all-06 	Sealing carrier profile for external corner (usable on both sides)	aluminium bright
DWG No. dwg 206 	Joint profile for corner, closure joints and wind barrier	CR neoprene black
DWG No. dwg all-02 	External corner profile 30 x 30 mm, visible, for all grids with system depth 56/66 mm	aluminium bright
DWG No. dwg all-16 	Spacer for horizontal joints at fitted tiles	aluminium bright

# ADS standard details

## View of joint profiles on vertical substructure

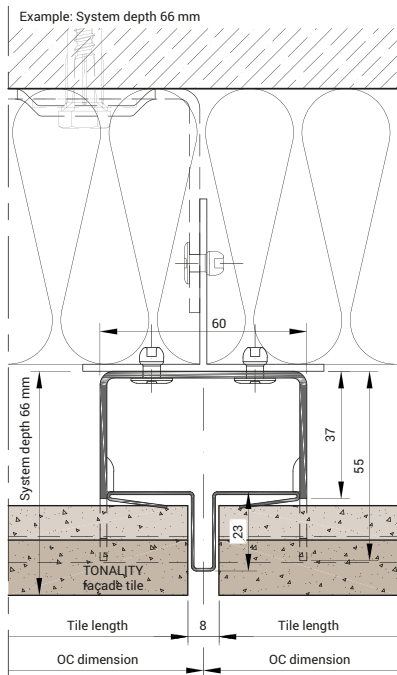

Closed-joint profile (23 mm)

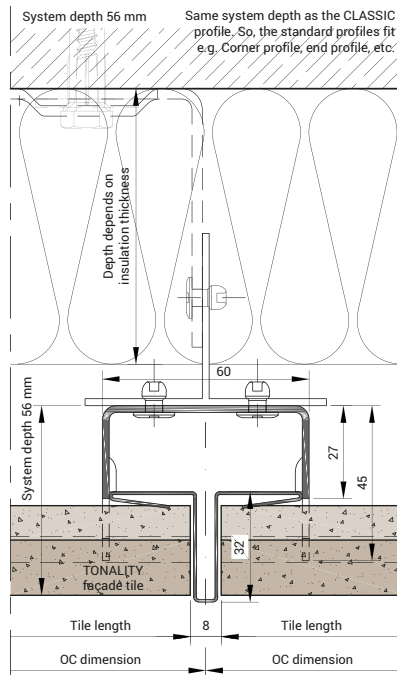

Closed-joint profile (32 mm)

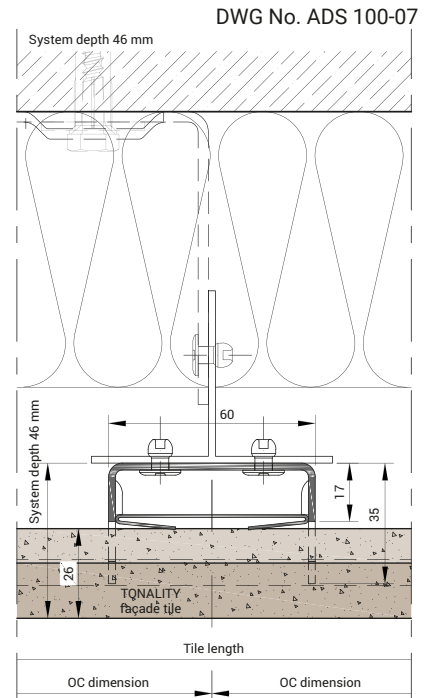

End profile for closure

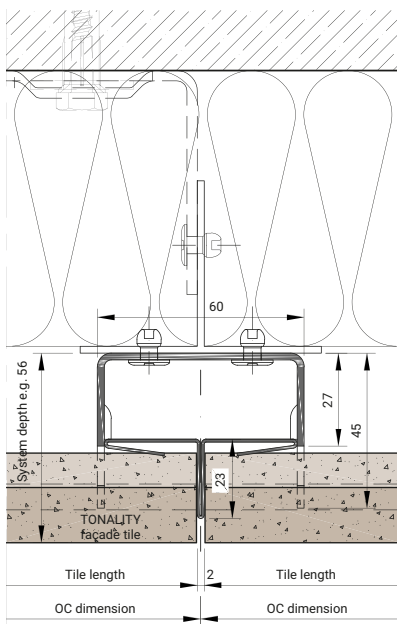

Fine joint profile (23 mm)

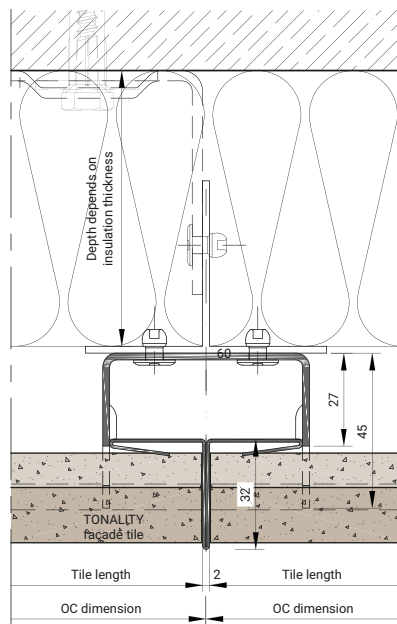

Fine joint profile II  
(32 mm with notches in horizontal joint)

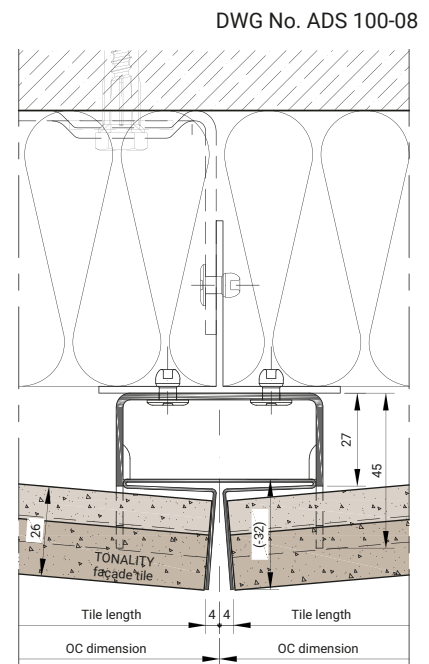

Open joint profile (30 mm)  
Due to production tolerances, it is possible that the open profile will not end precisely at the tile surface.

### Vertical section of parapet

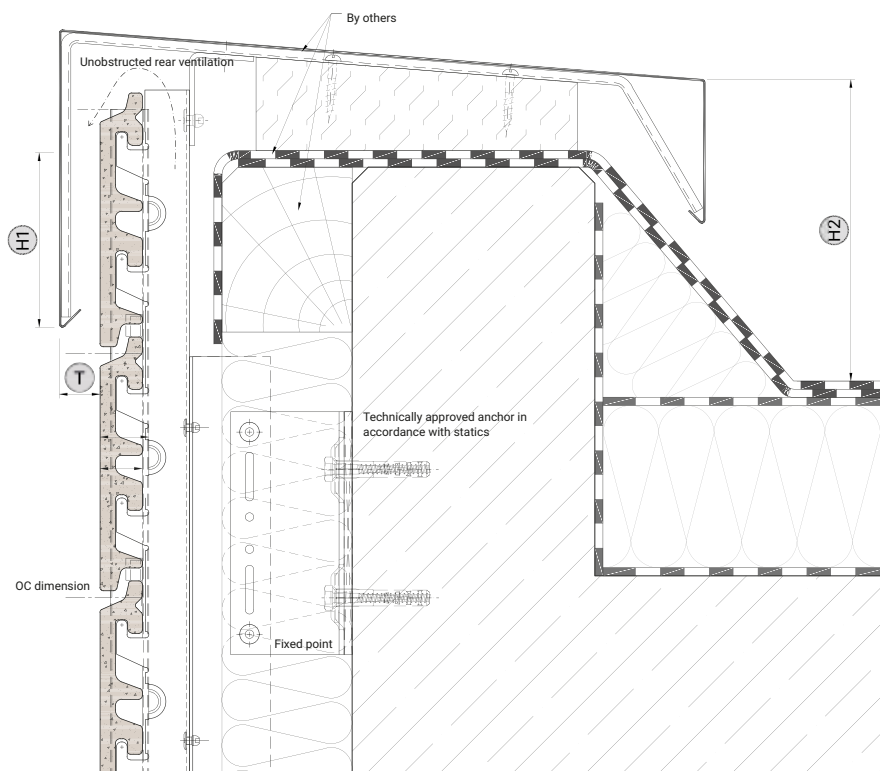

DWG No. ADS 100-20

#### Flat roof guideline requirements

- H1** The outer, vertical leg of covers or copings must overlap the upper edge of render or cladding.
- Building height:
  - up to 8 m: min. 50 mm
  - over 8 to 20 m: min. 80 mm
  - over 20 m: min. 100 mm
- H2** The roof edge closure height must be as follows:
  - Roof pitches up to 5° approx. 100 mm
  - Roof pitches > 5° approx. 50 mm above the covering surface or gravel layer.
 Roof edge closures must slope toward the roof.
- T** The overhang of covers or copings must have a drip edge, at least 20 mm away from the protected building elements.

### Vertical section of base

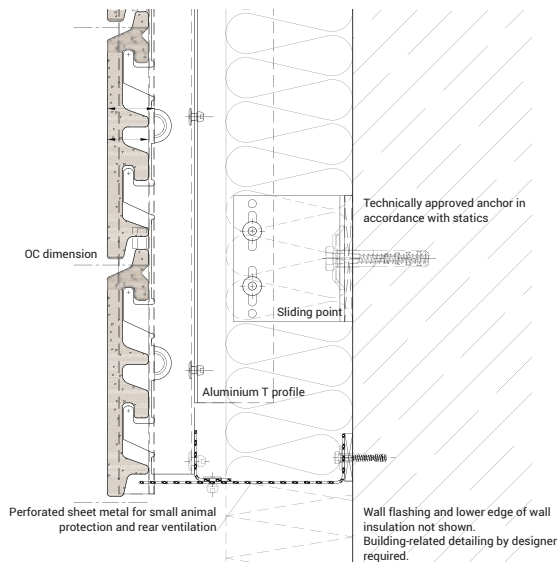

DWG No. ADS 100-21

# ADS standard details

## Vertical sections of windows

DWG No. ADS 100-15

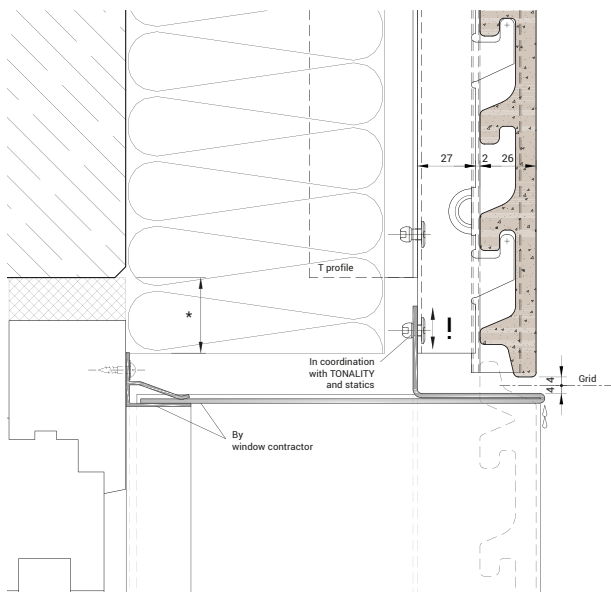

Window lintel with sheet metal cladding (without sun protection)

DWG No. ADS 100-17

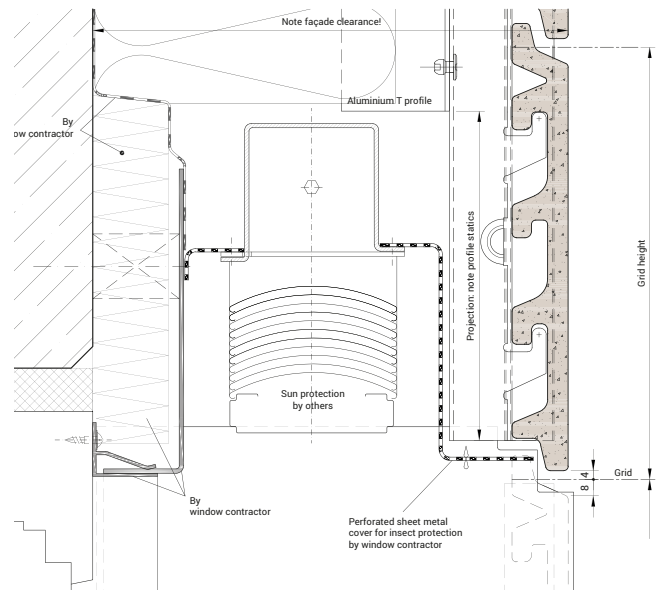

Window lintel with sun protection

DWG No. ADS 100-16

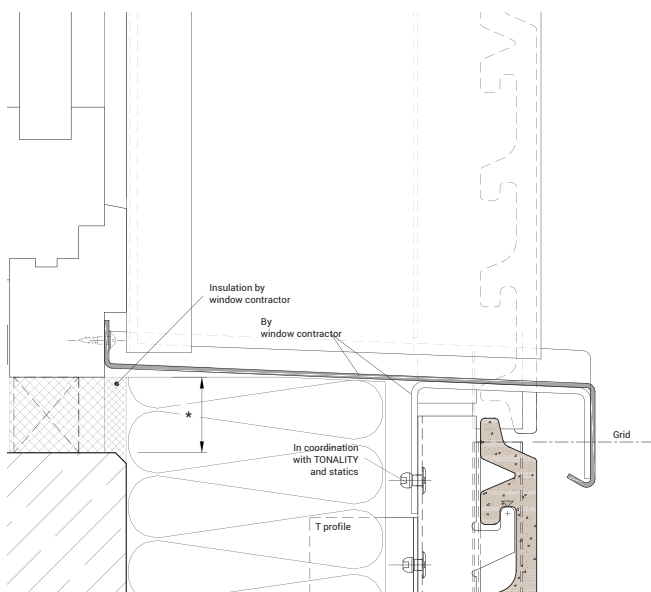

Parapet with window sill connection

DWG No. ADS 100-15.1

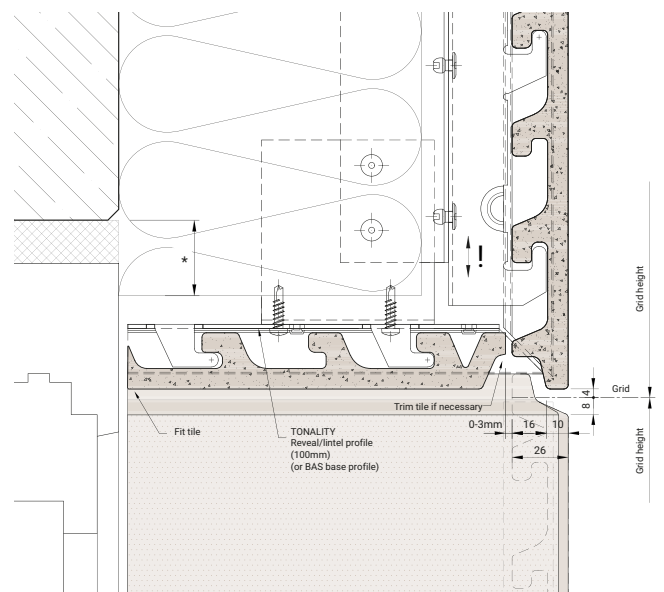

Window lintel with TONALITY cladding (without sun protection)

\* Insulation must be implemented in accordance with the current Energy Saving Ordinance (EnEV).

## Horizontal sections of windows

DWG No. ADS 100-14

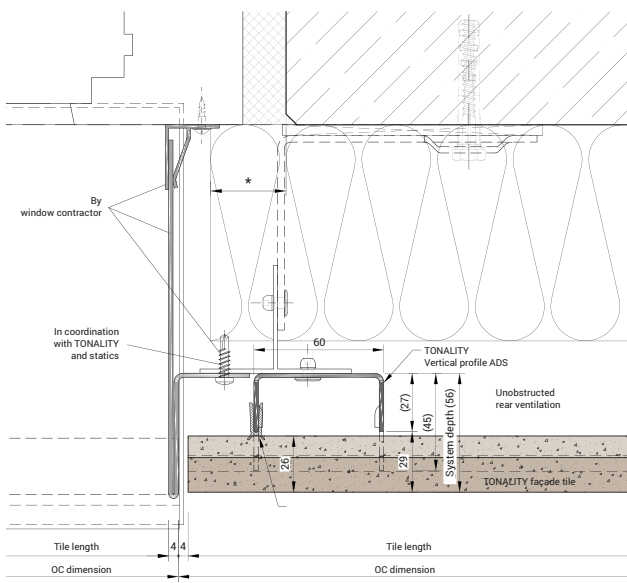

Window reveal with sheet metal cladding on vertical primary substructure

DWG No. ADS 100-18

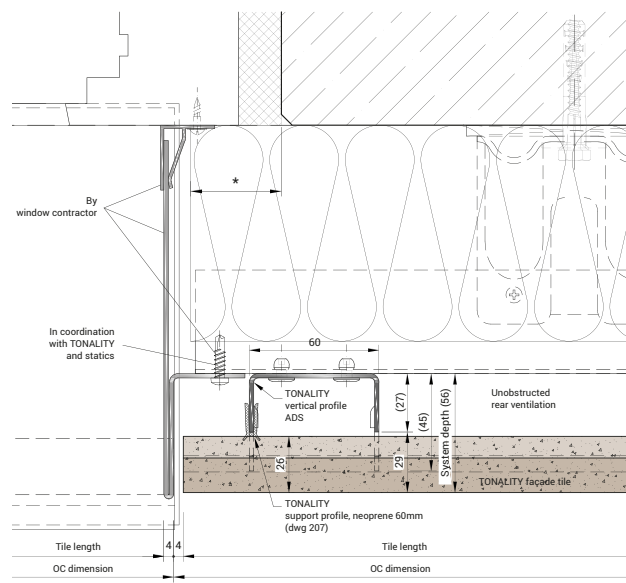

Window reveal with sheet metal cladding on horizontal primary substructure

\* Insulation must be implemented in accordance with the current Energy Saving Ordinance (EnEV).

# ADS standard details

## Horizontal sections of external corners

DWG No. ADS 100-09

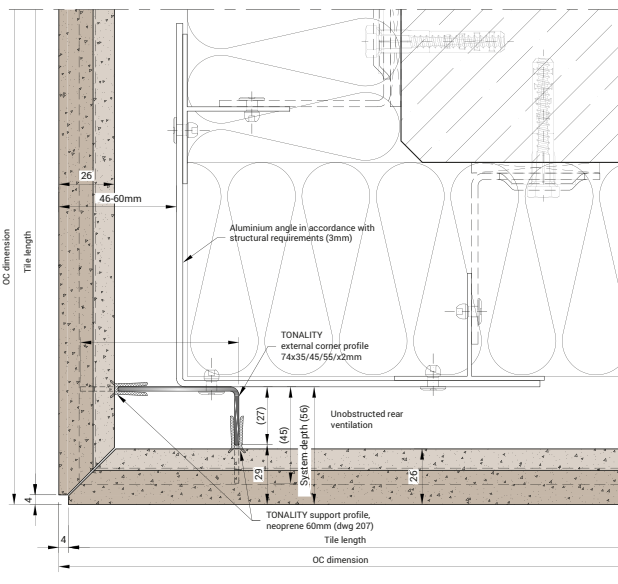

External corner 90° – TONALITY on vertical primary substructure, mitred TONALITY – external corner profile 90° 74 x 45 x 2 mm. The edges of mitre cuts must always be provided with a 4 mm chamfer. The external corner profile can be attached to an aluminium sheet.

DWG No. ADS 100-10

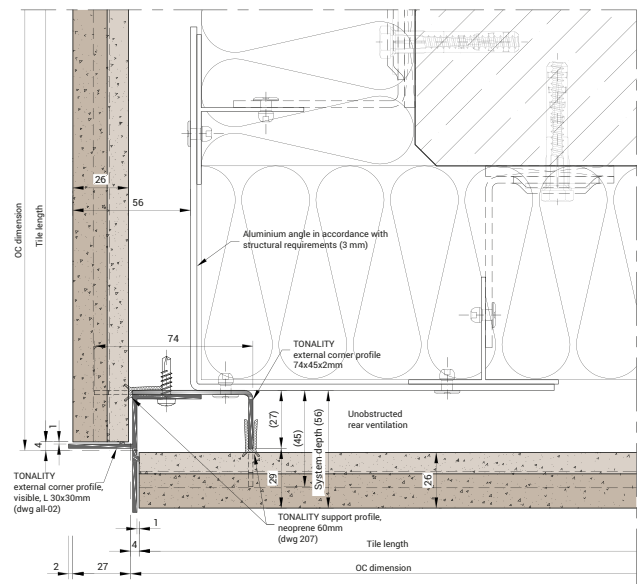

External corner 90° – TONALITY on vertical primary substructure, TONALITY with corner profile – visible external corner profile. The visible external corner profile is attached to the external corner profile 74 x 45 x 2 mm.

## Horizontal sections of internal corners

DWG No. ADS 100-11

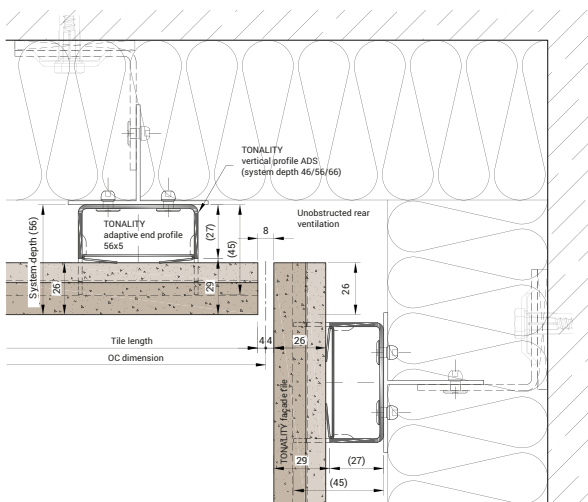

Internal corner 90° with ADS end profile

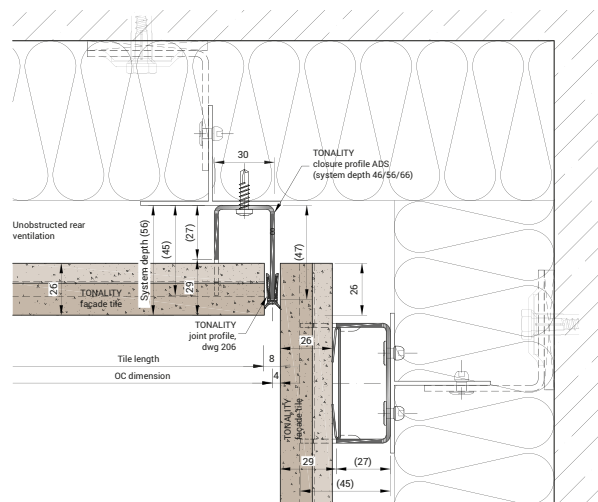

optional: Internal corner 90° with ADS closure and joint profile

### Horizontal section of external corner with wind barrier

DWG No. ADS 100-22

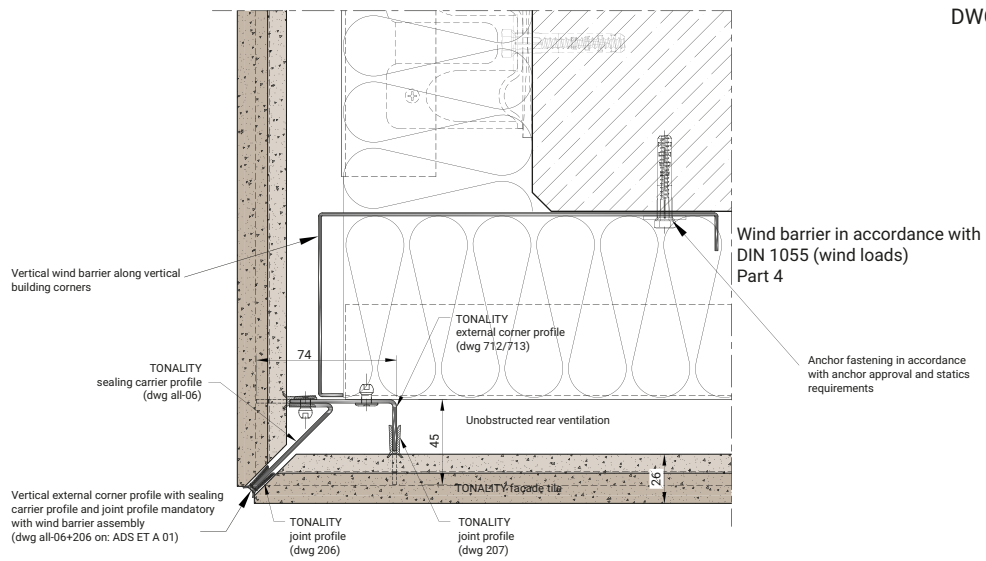

### Curved walls

DWG No. ADS 100-23

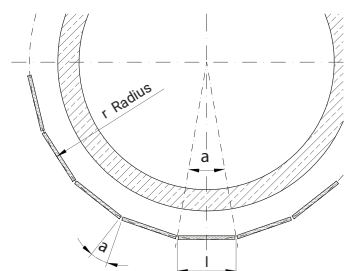
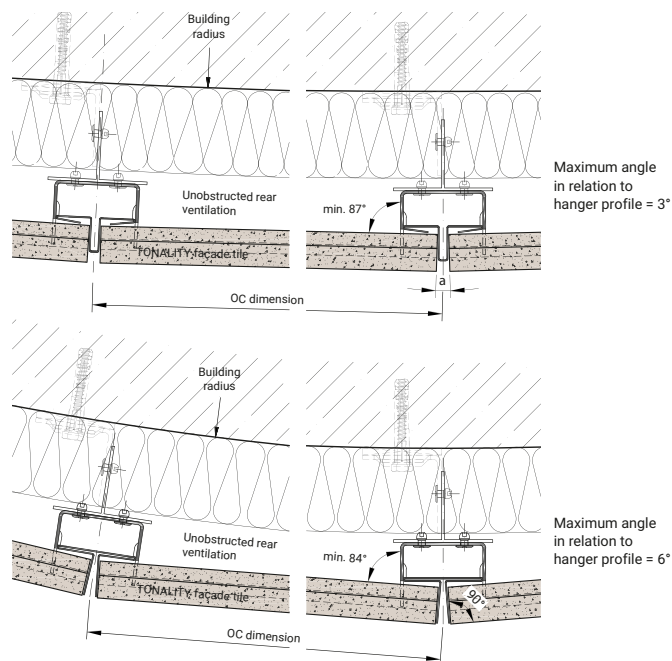

Formula:  $\sin \frac{l}{r} = a$

l = Length/OC dimension  
 r = external radius of façade  
 a = Angle between tiles

Example:  
 l = OC dimension 450 mm  
 r = 5,150 mm  
 $\sin = 450 : 5,150 = 5.01^{\circ}$   
 a = 5.01°

up to 6° = closed joint profile  
 6° to 12° = open joint profile

Large radii can also be built using the BAS system design.

## ADS – installation of cut tiles

### Cut tiles with spacer

DWG No. dwg all-16

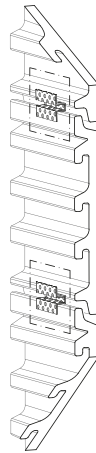
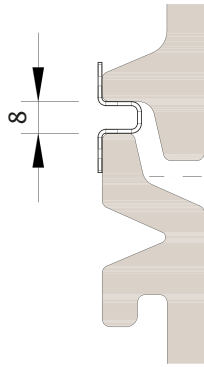

### Installation instructions

1. Mark the cut tile.
2. Cut with wet saw and recommended cutting blade.
3. Place cut tile face down on a flat substrate.
4. Set up the required tile spacing using a system substructure profile with hangers spaced in accordance with grid.
5. Place the spacers in position (two pieces per cut tile).
6. Fill the resulting joint with spacer adhesive, spread smoothly and evenly and allow to set.
7. Hang the facade tile with scheduled cutting mark on the system substructure profile.



**Installation with spacer – vertical section of window lintel**

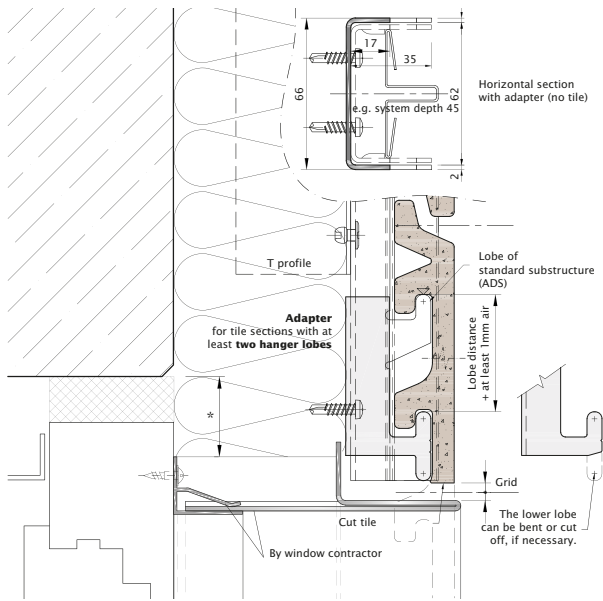

Detail of fitted tile fastening above the window

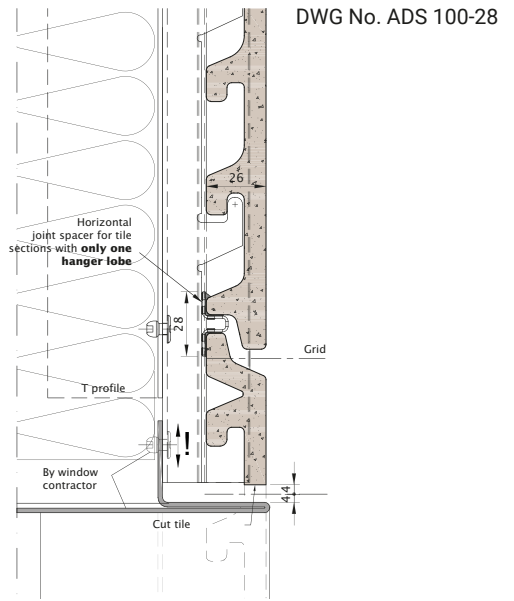

**Installation with spacer – vertical section of window spandrel**

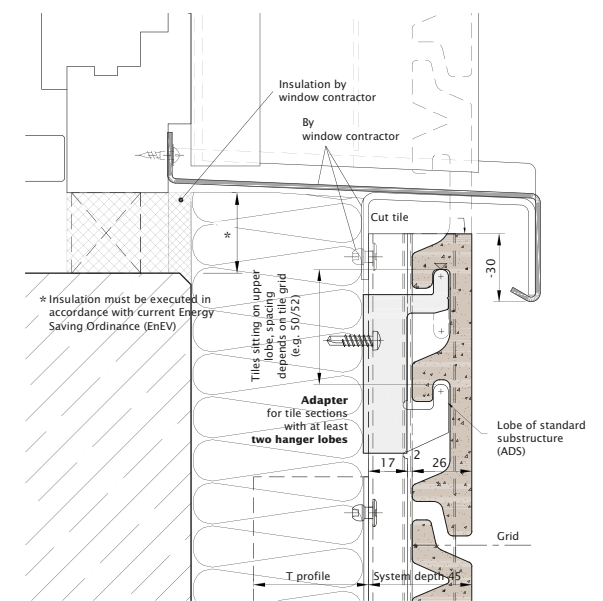

Detail of fitted tile fastening below the window

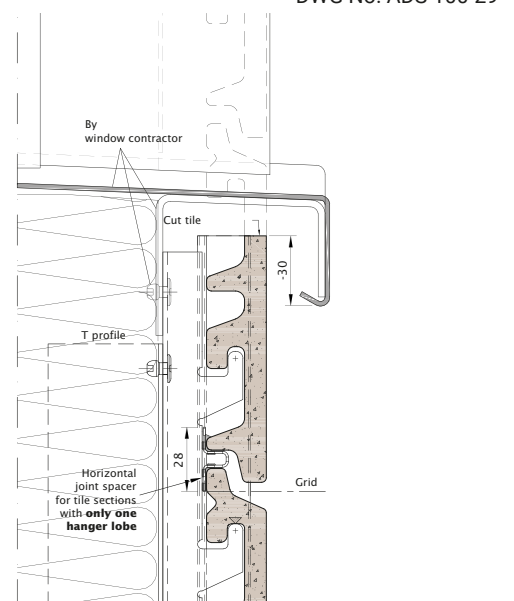

## ADS on wooden primary substructure

### TONALITY ADS on wooden primary substructure

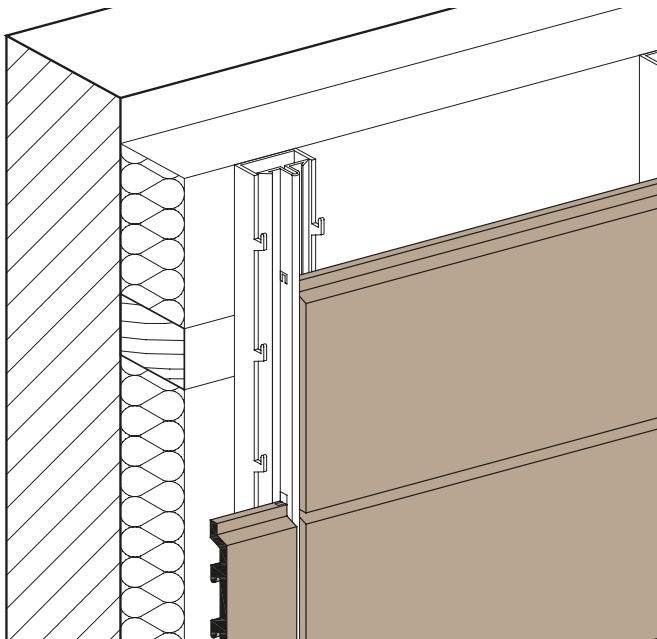

The details must be adapted to the material of the specific substructure selected.

#### ADS system design

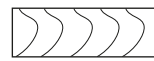

1 Wood primary substructure

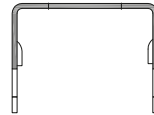

2 ADS TONALITY adaptive vertical profile



3 Wood screw



4 TONALITY adaptive joint profile



5 Tonalite facade tile

**TONALITY ADS on wooden primary substructure – Vertical section**

DWG No. ADS 100-19

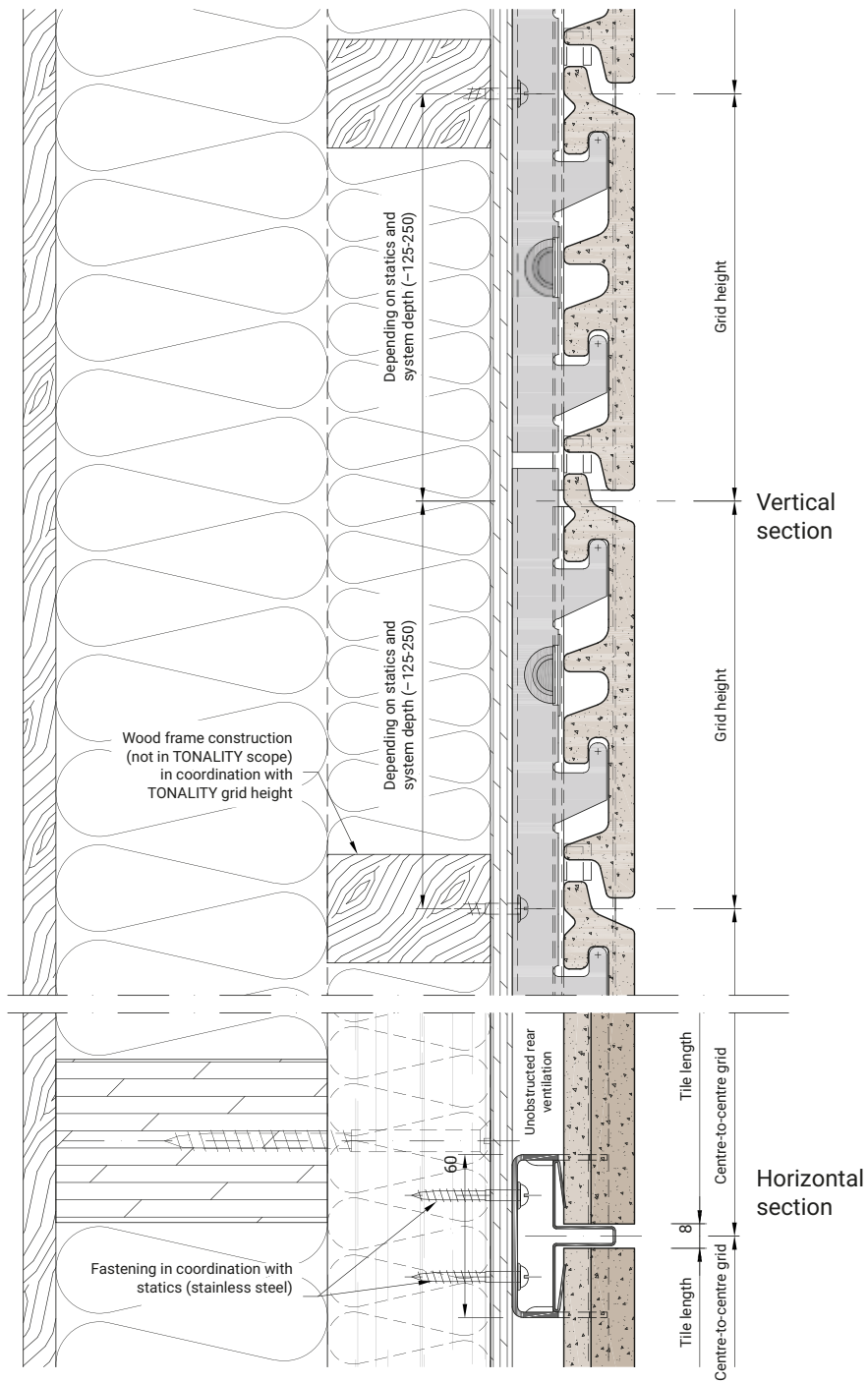

# Adaptive systems

## TONALITY Adaptive system T-Line

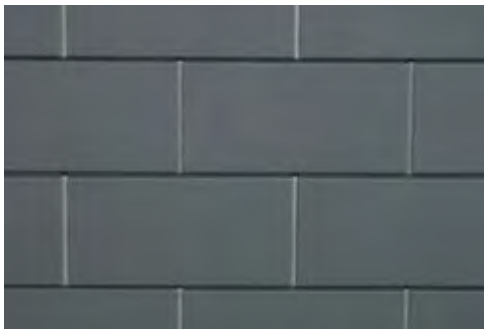

A classic brick wall appearance can be created using a TONALITY T-Line system. It is suitable for all tile types and sizes. As an adaptive system, T-Line can be installed on vertical and horizontal substructures.

The TONALITY Adaptive system T-Line consists of type A and type B profiles that are attached alternately to the primary substructure which are attached in a staggered lay-out. Type A and type B joint profiles are available as a closed joint (8 mm).

DWG No. T-Line 600-01

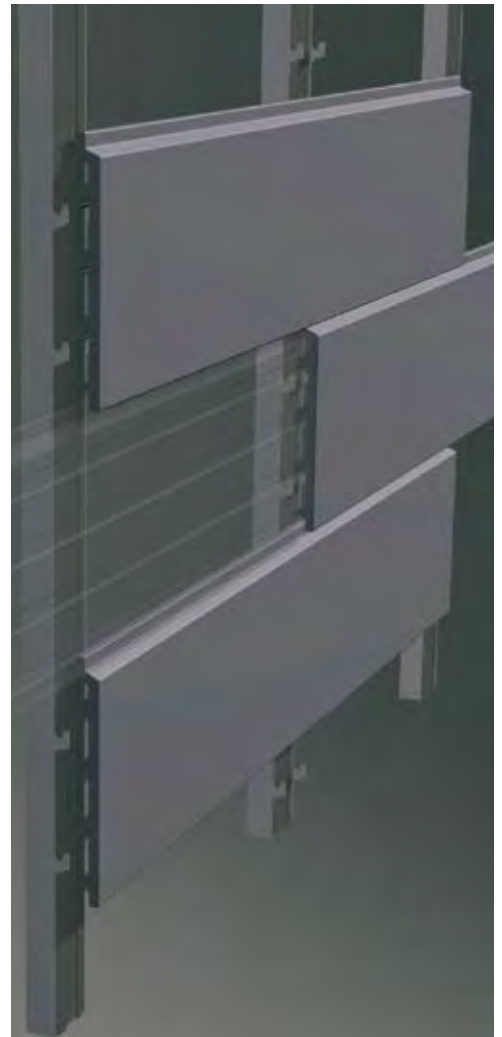
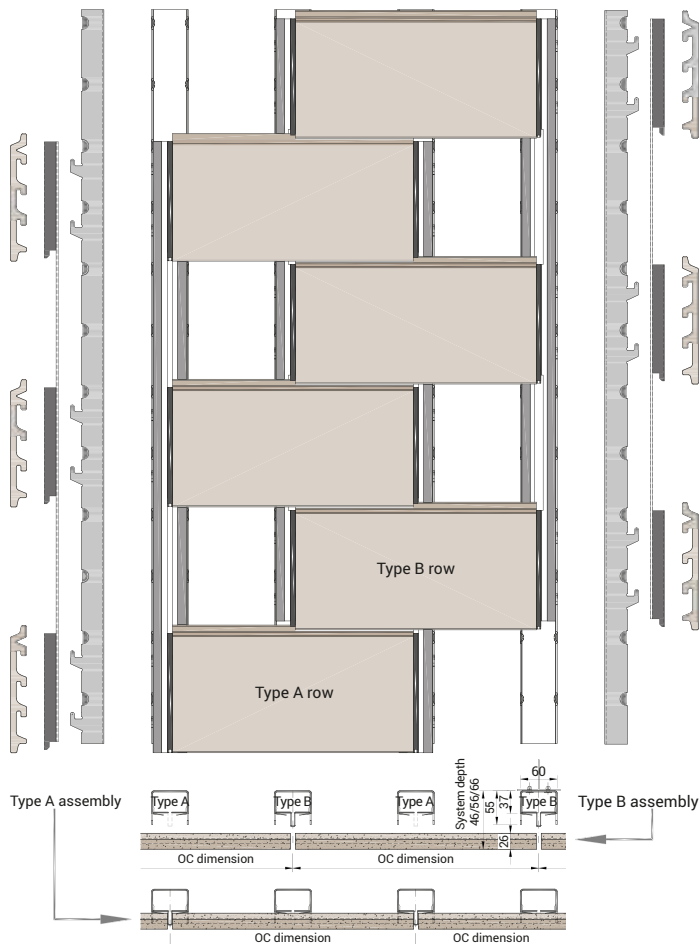

### TONALITY adaptive system Siding



The TONALITY Siding system substructure is ideally suited for the design of a TONALITY tile facade with the appearance of weatherboard (“shiplap” effect). All tile types and sizes can be used for this TONALITY system substructure. The sloping position and overlapping of TONALITY tiles is achieved by the shape of TONALITY Siding system substructure profiles.

The continuous vertical joints can be designed with a closed 8 mm joint or a fine 2 mm joint, either flush with the tile face or recessed.

DWG No. SID 500-01

DWG No. SID 500-03

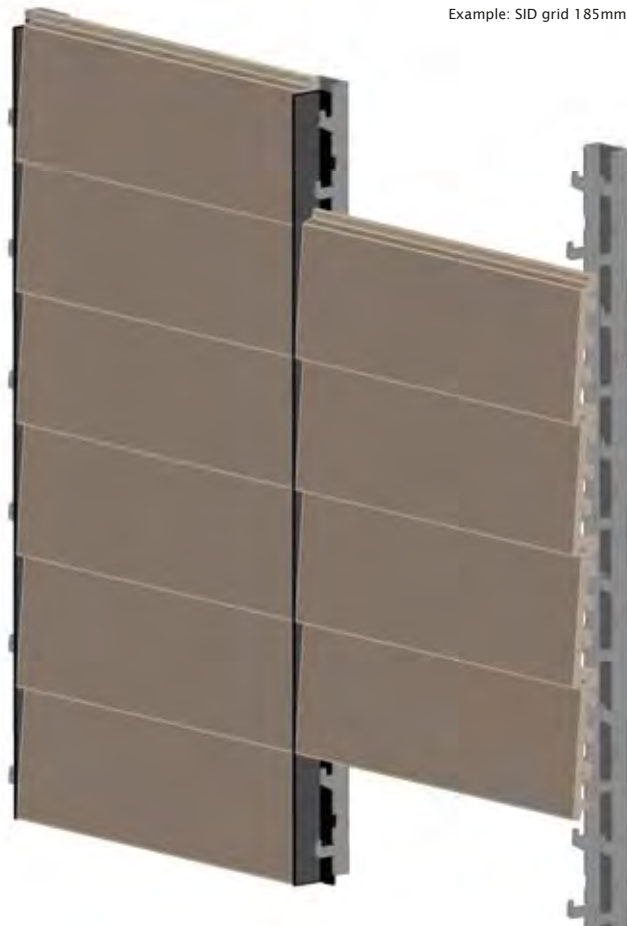
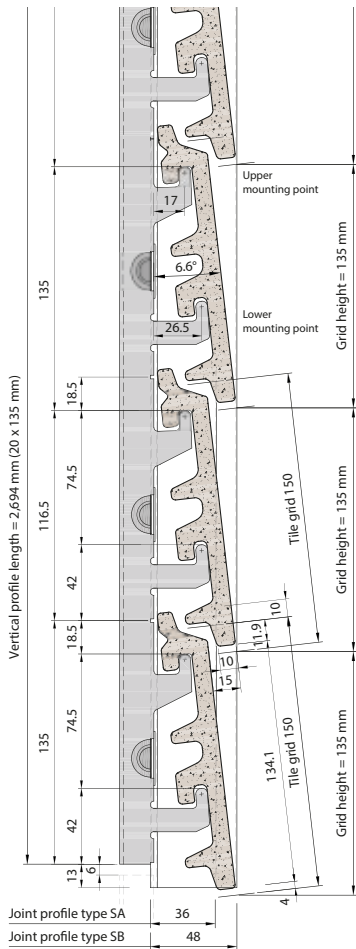

Example: SID grid 185mm



# ADS portrait installation

## Portrait installation

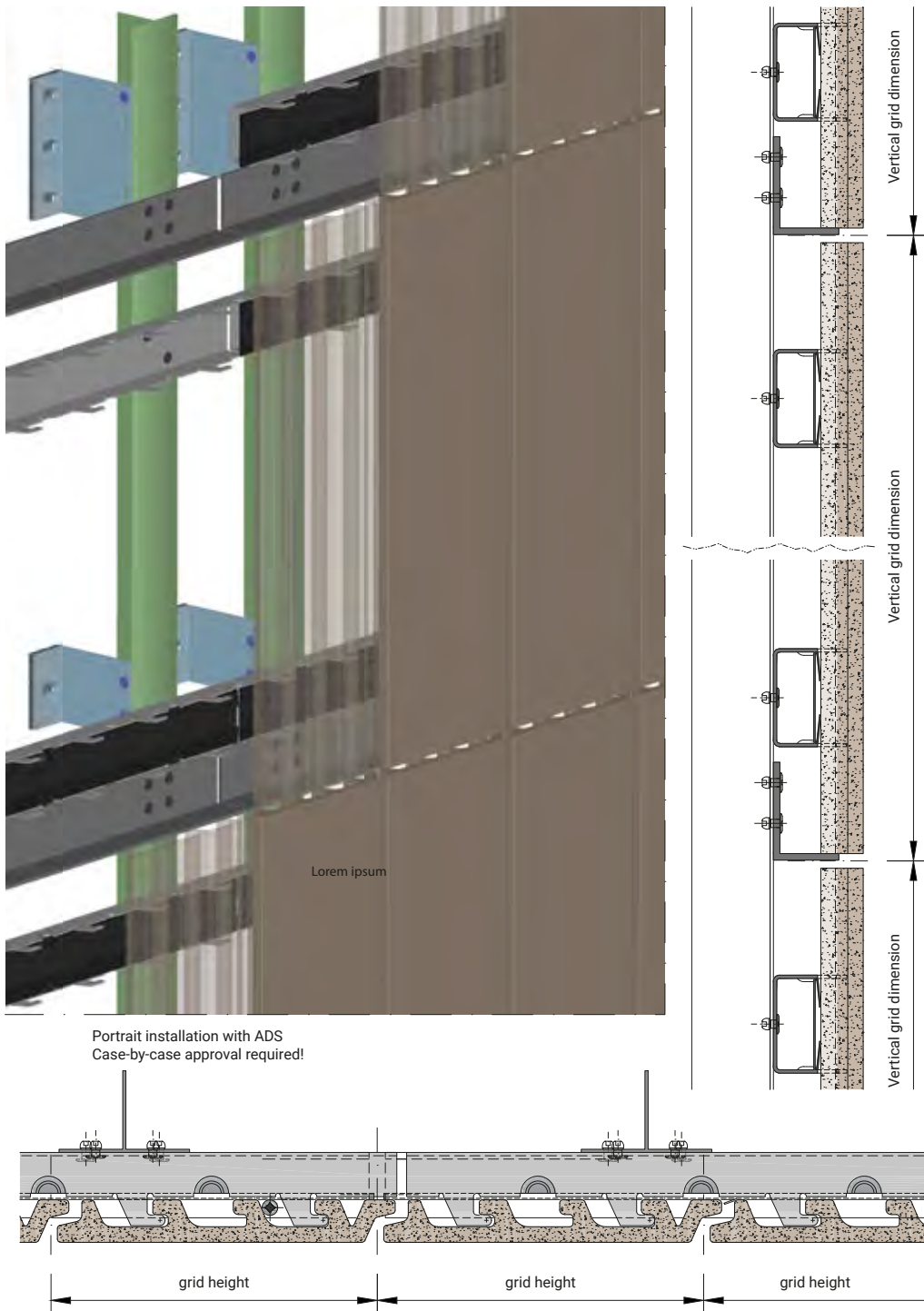

# Permitted spans

## National technical approval No. Z-10.3-798

The wind loads specified in the following tables are the design values of resistance for building components to wind loading. Linear interpolations may be made between two adjacent table values. The values apply to tiles with a thickness of 26 mm.

In each case, the permissible span is the shorter span from the wind load pressure and wind suction tables. To obtain the maximum permissible bearing spans, the wind loads specified in the table must be compared with the design values of building components to wind loading for the construction project.

### Max. bearing spans of cladding tiles for the design values of building components under positive wind load pressure for the 'ADS', 'BAS' and 'BAS-Flex' systems

Positive wind load pressure* (kN/m <sup>2</sup> )	+0.75	+1.20	+1.50	+2.25	+3.00	+3.75	+4.50
	Maximum spans (m)						
Tile 150	1.20	1.20	1.20	1.20	1.10	0.98	0.89
Tile 175	1.20	1.20	1.20	1.20	1.10	0.98	0.89
Tile 200	1.60	1.60	1.60	1.28	1.10	0.99	0.90
Tile 225	1.60	1.60	1.60	1.30	1.12	1.00	0.92
Tile 250	1.60	1.60	1.60	1.27	1.10	0.99	0.90
Tile 300	1.60	1.60	1.60	1.26	1.10	0.98	0.89
Tile 400	1.60	1.60	1.60	1.37	1.18	1.06	0.97

\* The partial stability coefficient  $\gamma_M$  has already been taken into consideration.

### Max. bearing spans of cladding tiles for design values of building components under negative wind load pressure for the 'ADS' and 'BAS-Flex' systems

Negative wind load pressure* (kN/m <sup>2</sup> )	-0.75	-1.20	-1.50	-2.25	-3.00	-3.75	-4.50
	Maximum spans (m)						
Tile 150	1.20	1.20	1.20	1.20	1.20	1.01	0.84
Tile 175	1.20	1.20	1.20	1.20	1.20	1.20	1.10
Tile 200	1.60	1.60	1.60	1.60	1.35	1.08	0.90
Tile 225	1.60	1.60	1.60	1.35	1.11	0.89	0.74
Tile 250	1.60	1.60	1.60	1.20	0.90	0.72	0.60
Tile 300	1.60	1.60	1.60	1.27	0.95	0.76	0.63
Tile 400	1.60	1.60	1.28	0.85	0.64	0.51	0.43

\* The partial stability coefficient  $\gamma_M$  has already been taken into consideration.



### Max. bearing spans of cladding tiles for design values of building components under negative wind load pressure for the 'BAS' system with screw connection

Negative wind load pressure* (kN/m <sup>2</sup> )	-0.75	-1.20	-1.50	-2.25	-3.00	-3.75	-4.50
	Maximum spans (m)						
Tile 150 a) or b)	1.20	1.20	1.20	1.16	0.87	0.69	0.58
Tile 175 a) or b)	1.20	1.20	1.20	0.97	0.73	0.58	0.49
Tile 200 a) b)	1.60 1.60	1.60 1.60	1.60 1.20	1.60 0.80	1.30 0.60	1.04 0.48	0.87 0.40
Tile 225 a) b)	1.60 1.60	1.60 1.36	1.60 1.02	1.35 0.68	1.11 0.51	0.89 0.41	0.74 0.34
Tile 250 a) b)	1.60 1.60	1.60 1.10	1.60 0.83	1.20 0.55	0.90 0.41	0.72 0.33	0.60 0.28
Tile 300 a)	1.60	1.60	1.60	1.11	0.83	0.67	0.56
Tile 400 a)	1.60	1.60	1.20	0.80	0.60	0.48	0.40

\* The partial stability coefficient  $\gamma_M$  has already been taken into consideration. a) Spacing of screw connections = 1x nominal tile height b) Spacing of screw connections = 2x nominal tile height

### Max. bearing spans of cladding tiles for design values of building components under negative wind load pressure for the 'BAS' system with rivet connection

Negative wind load pressure* (kN/m <sup>2</sup> )	-0.75	-1.20	-1.50	-2.25	-3.00	-3.75	-4.50
	Maximum spans (m)						
Tile 150 a)	1.20	1.20	1.20	1.20	1.15	0.92	0.77
Tile 175 a)	1.20	1.20	1.20	1.12	0.84	0.67	0.56
Tile 200 a) b)	1.60 1.60	1.60 1.60	1.60 1.29	1.60 0.86	1.35 0.65	1.08 0.52	0.90 0.43
Tile 225 a) b)	1.60 1.60	1.60 1.36	1.60 1.02	1.35 0.68	1.11 0.51	0.89 0.41	0.74 0.34
Tile 250 a) b)	1.60 1.60	1.60 1.10	1.60 0.83	1.20 0.55	0.90 0.41	0.72 0.33	0.60 0.28
Tile 300 a)	1.60	1.60	1.60	1.27	0.95	0.76	0.63
Tile 400 a)	1.60	1.60	1.28	0.85	0.64	0.51	0.43

\* The partial stability coefficient  $\gamma_M$  has already been taken into consideration. a) Spacing of rivet connections = 1x nominal tile height b) Spacing of rivet connections = 2x nominal tile height

# Privacy and sun protection systems

## Lamella, Baguette and Square Brise Soleil

The Lamella, Baguette and Square Brise Soleil optimally complement the TONALITY facade tile product range. Integration of Brise Soleil early in the design process provides scope for creative facade design concepts. You can choose just to match the clay tile facade or alternatively to use the Brise Soleil as decorative elements in their own right either individually or in combination with metal, ceramic, glass and rendered facades. The precast elements Brise Soleil are available in numerous standard dimensions and all colours from the NATUR, BRICK RED, NUANCE and NOBLESSE COLOR series as shown

on page 58/59. Whether used inside or outside the building, or in either vertical or horizontal format these Brise Soleil help designers to create truly unique buildings.

The TONALITY sight and sun protection elements are available in standard dimensions from 300 to 1,600 mm.

Please contact our technical support team for fixing options for privacy and sun protection systems.

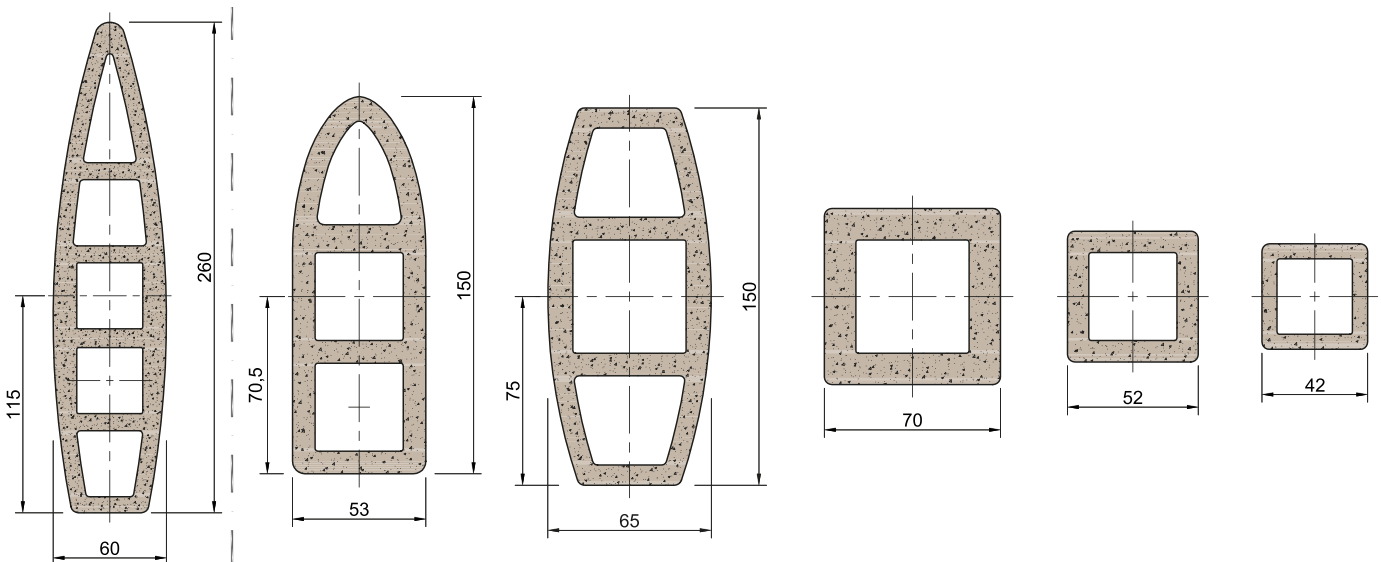
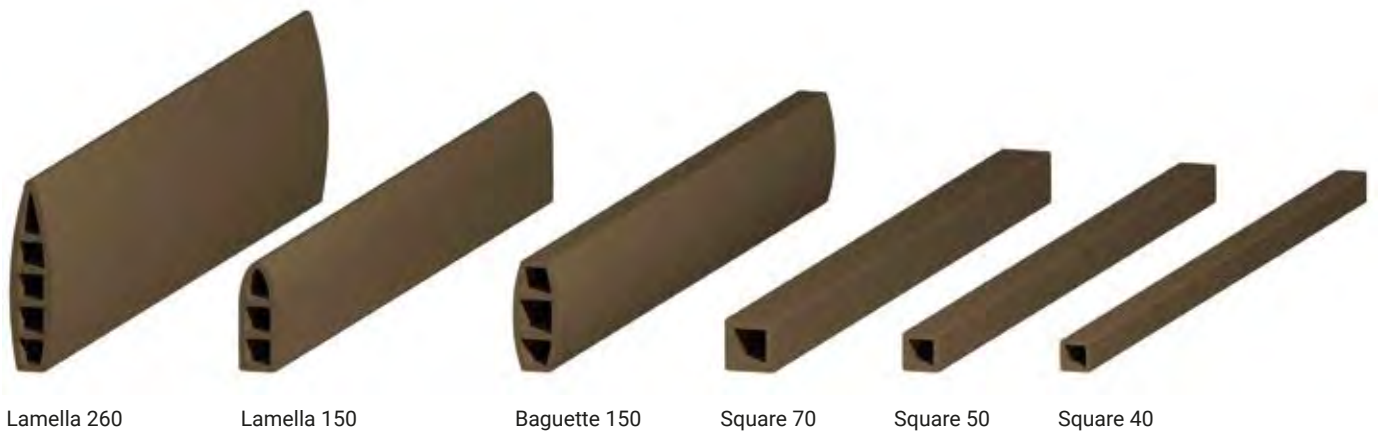

# Environmental declaration

## Sustainable building with TONALITY facade tiles

The data includes raw material extraction and energy supply, raw material transport and product manufacturing, including packaging and its disposal.

Parameter	Units per m <sup>2</sup>	TONALITY value
Total non-renewable primary energy	megajoules	651
Total renewable primary energy	megajoules	59.4
Global warming potential	kg CO <sub>2</sub> equivalent	43.1
Depletion of stratospheric ozone layer potential	kg CFC11 equivalent	6.32E-9
Summer smog potential	kg SO <sub>2</sub> equivalent	1.12E-1
Acidification of soil and water potential	kg (PO <sub>4</sub> ) <sub>3</sub> equivalent	8.83E-2
Nutrient input/eutrophication potential	kg ethylene equivalent	9.04E-3

### Explanation of measured quantities:

**Total non-renewable primary energy:** Effect: Non-renewable primary energy as a measure of fossil fuel energy sources (oil, natural gas, coal, lignite and uranium) and weighted in line with the scarcity.

**Total renewable primary energy:** Effect: Renewable primary energy as the measure of the use of renewable energy (wind power, hydro power, biomass, solar energy).

**Global warming potential:** Global Warming Potential (GWP) > global warming; Effect: Increased warming of the troposphere due to anthropogenic greenhouse gases such as burning fossil fuels.

**Depletion of stratospheric ozone layer potential:** Depletion Potential (ODP) > ozone layer destruction; Effect: Reduction of ozone concentration in the stratosphere due to emissions such as chlorofluorocarbons (CFCs).

**Summer smog potential/photochemical ozone:** Creation Potential > summer smog; Effect: Development of ozone near the ground under the influence of sunlight due to photochemical reaction of nitrogen oxides with hydrocarbons and volatile organic substances.

**Acidification of soil and water potential:** Acidification Potential (AP) > acid rain; Effect: Reduction of rainwater pH due to leaching of acid forming gases such as sulphur dioxide (SO<sub>2</sub>) and nitrogen oxide (NO<sub>x</sub>).

**Nutrient input/eutrophication potential:** (EP) > over-fertilisation; Effect: Excessive content of nutrients in water table and in rural areas due to substances such as phosphorus and nitrogen from agriculture, combustion processes and waste water.

# Design basics

## Building physics requirements (air intake, ventilation and rear ventilation)

The interaction of the outer wall with the external wall cladding must take the assessment of thermal insulation, soundproofing, water vapour control and fire protection into account. As a rule, rear-ventilation is required to reliably discharge moisture from the building, to drain off any possible penetrating precipitation, for capillary separation of cladding from the insulation or surface of the outer wall and for discharging any condensation inside the cladding.

The cladding facade should be situated at a distance of at least 20 mm from the thermal insulation or the surface of the outer wall. The distance may be reduced locally to 5 mm by the substructure or irregularities in the wall, for example. To ensure long-term, reliable functioning of the cladding facade, air intake and ventilation openings must be designed with cross-sections of at least 50 cm<sup>2</sup> per 1 m length of wall.

## Structural requirements

The cladding facade must be free from stress forces once installed. Deformation stress loads must not damage the cladding or substructure at connecting or fixing points. Similar or identical movements must be possible in the substructure and cladding in the region of expansion joints in the structure. This also applies by analogy for movement joints in the substructure. Anchor points must be provided for scaffolding. During installation, the insulation must be fixed permanently in place, forming a seamless barrier with stable dimensions, also taking any possible moisture ingress into consideration due to the weather conditions. Wooden and wood-based materials must be protected in accordance with DIN 68800-1, -2, -3 and -5.

Moisture penetration through vertical wooden load-bearing battens is prevented by using a system-relevant substructure. Harmful effects, e.g. between different building materials – even without direct contact, especially in the direction of the flow of water – must be excluded by structural measures and by selecting suitable building materials.

### Requirements for installation

The geometric assumptions of static engineering calculations and implementation plans must be complied with during installation.

## Stability

The stability of the facade cladding must be proven and demonstrated. TONALITY facade tiles may only be used as a cladding facade if a national technical approval or European technical approval/evaluation has been issued for the facade tiles for this field of use or an "approval for an individual case" is available from the building super-

visory authority responsible for the specific individual case of implementation. The verification of stability in accordance with national or state building regulations must be provided by the building's owner or his approved agent.

## Assumed Loads, design values, setting out

All parts of the facade cladding must be designed taking the safety factors or permitted stress forces of the appropriate standards or national technical approvals into account. DIN 18516-1 must be taken into consideration when calculating internal forces. Design values for TONALITY facade tiles must be taken from the respective approval. The permitted forces for fastening elements must be taken from the national technical approvals or test certificates. The load-bearing capacity of fastenings and connections not governed in standards or technical approvals, the national application document must be demonstrated and proven for all components of the cladding facade. Reduced wind loads may be assessed for the facade tiles for

buildings with rear-ventilated rainscreen facades if the external wall cladding qualifies as permeable to wind.

The substructure system must not carry any additional loads such as components for advertising or window systems. In verifying the stability, at least an additional 20 mm must be added to the design separation assessed between outer wall and cladding to take deviations in the dimensions of the outer wall into account. Deviations to this are permitted, if only small dimensional deviations have been determined on-site.

## Verification of suitability

TONALITY facade tiles 26 mm thick may be used as non-combustible building materials in accordance with national technical approval Z-10.3-798, or 22 mm thick TONALITY facade tiles in accordance with national technical approval Z-10.3-796 within the meaning of

## Fire protection

Rear-ventilated rainscreen facades are traditionally amongst the safest external wall cladding assemblies. The contemporary fire protection requirements for rear-ventilated rainscreen facades can be obtained from specific state or national building regulations. Building authority requirements for fire behaviour are based on the building's height and use.

## Protection against condensation

Protection against condensation is a major pre-condition for thermal insulation functioning in external walls. Formation of condensation and subsequent formation of mould on the inside of the outer wall can be prevented by using rear-ventilated rainscreen facades. These permit problem-free, physically correct external wall constructions with decreasing resistance to vapour diffusion in the layers toward the exterior. Moisture in the building and from inside the building is

## Insulation

Only standardised or technically approved, type WAB (external thermal insulation for use beneath cladding) may be used in accordance with DIN 4108-10:2008-06 for thermal insulation in rear-ventilated rainscreen facades. Fleece-backed mineral fibre insulation in accordance with DIN EN 13162 is preferable in open-jointed facades. Facade insulation panels must be installed fitting tightly together in formation, between the substrate and insulation layer in accordance with structural standards or manufacturer's specifications. They must be

## Weather protection

Rear-ventilated rainscreen facades ensure lasting protection for buildings from atmospheric precipitation. They are allocated to the highest requirements group III – heavy driving rain loads – of DIN 4108-3. This shows rear-ventilated rainscreen facades are especially resistant to driving rain. Even in areas with high annual precipitation and windy locations, rear-ventilated rainscreen facades prevent water penetration into the building without impairing the expulsion of moisture

national or state building regulations when attached to metallic substructures for rear ventilated external wall cladding in accordance with DIN 18516-1.

According to the national technical approval, the TONALITY facade system is non-combustible, as long as any thermal insulation present consists of non-combustible mineral fibre thermal insulation. Therefore, TONALITY facade tiles in the form of a rear-ventilated rainscreen facade can be used for every type and height of building.

removed via the rear ventilation gap, without the formation of condensation on the inside of the external wall.

The improved drying behaviour of outer walls with rear-ventilated rainscreen facades contributes to a healthy indoor climate and benefits the energy balance, because otherwise increased humidity could only be removed by increased window ventilation. Verification opportunities for protecting against condensation forming are listed in DIN 4108-3.

mechanically attached using insulation fasteners ('fixing pins') and must be tightly connected to adjacent building components. Particularly high requirements are placed on the insulation in the external building envelope of so-called energy Efficient and Passivhaus buildings that are largely designed to function without supplementary heating. Suspended rear-ventilated rainscreen facades make an exemplary contribution to this ambitious overall energy concept for relieving the climate and the environment.

from inside the building. The consistent separation of the cladding facade from the structure of the building and insulation protects the building from the effects of weather. Both cooling down and heat losses in winter as well as heating up in summer are avoided. Stable, comfortable climates are achieved in the rooms inside. Structural components are protected against high temperature loads, which has a very positive impact on their working life.

## Design basics

### Substructure installation – primary substructure wall brackets

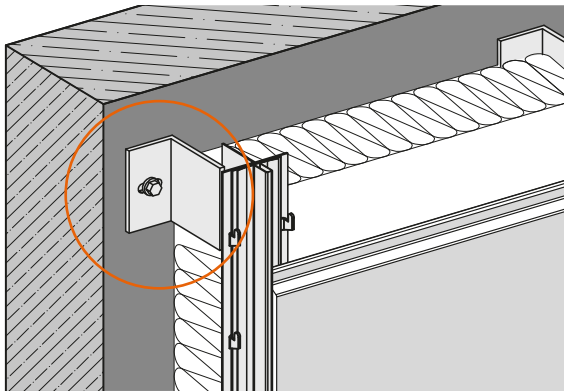

The wall brackets must be fitted at vertical axis separations and in the horizontal grid in accordance with static engineering calculations. Attention must be paid to ensure a precisely perpendicular alignment.

The system manufacturer's processing instructions for the primary substructure and anchors must be strictly adhered to during the installation of wall brackets. All brackets must be thermally insulated from the outer shell of the building using suitable underlays in accordance with DIN 18516. Care must be given to use technically approved anchoring elements in accordance with static engineering requirements. We recommend the dowel manufacturer completes a sufficient number of pull-out tests prior to starting installation work.

### Substructure installation – primary substructure vertical T-profile

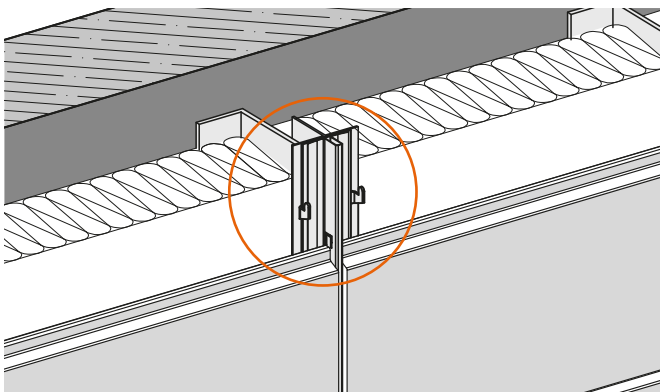

The vertical T-profiles must be adjusted to the facade alignment at the appropriate height on wall brackets and screwed or riveted in place in accordance with manufacturer's specifications.

Appropriate butt joints must be formed and both fixed and sliding point connections to absorb linear thermal expansion of the profiles must be built in during installation of the vertical T-profiles.

During implementation, ensure that the primary substructure and the TONALITY profile can expand uniformly and free from stress.

### Substructure installation – primary substructure horizontal L-profile – only applies to ADS

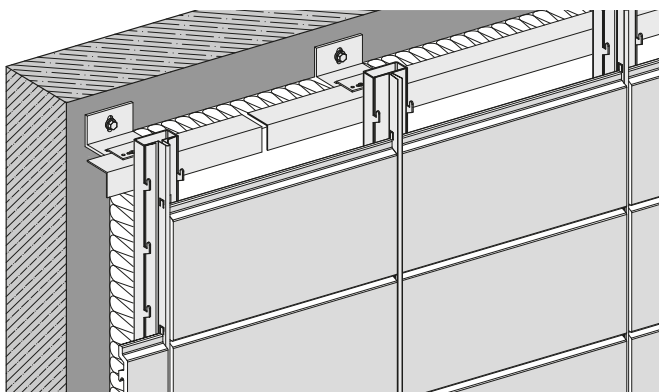

The horizontal L-profiles must be adjusted to the facade alignment at the appropriate height on wall brackets and screwed or riveted in place in accordance with manufacturer's specifications.

Appropriate butt joint formation and both fixed and sliding point connections to absorb linear thermal expansion of profiles must be built in during installation of the profiles. During implementation, ensure that the primary substructure and the TONALITY profiles can expand uniformly, free from stress. On thermal linear expansion grounds, we recommend restricting the profile length to a maximum of 3m. Ensure there is a sufficient gap between the profiles to avoid distortion due to linear thermal expansion

## Thermal installation

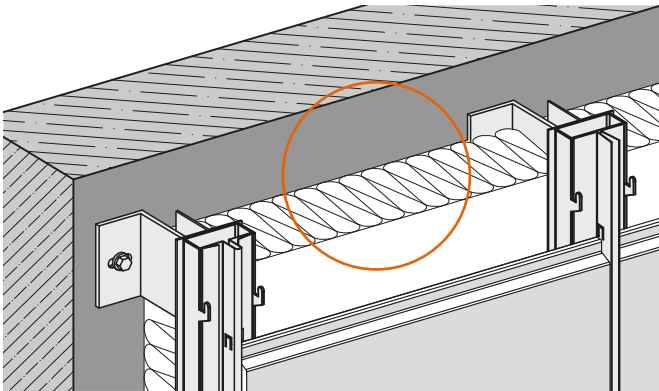

The thickness of thermal insulation and type of insulation are determined by the Energy Saving Ordinance or client specifications. Generally, the installation must be installed on wall surfaces which have been sanitized in compliance with manufacturer's guidelines.

Using perimeter insulation is recommended for the base area. Care must be taken that the insulation panels are pressed firmly together in the butt joints. All window, door and building joints must be checked for proper seals and, if applicable, visible defects must be reported to Project Management before proceeding with work.

## Fixed point – sliding point

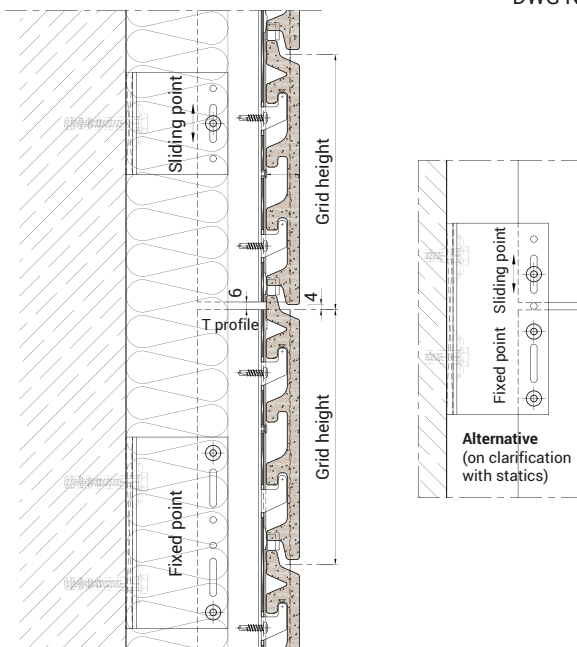

DWG No. BAS  
200-19

To ensure stress-free working of the aluminium substructure, it is absolutely essential to give formation of fixed and sliding points consideration during the installation of the primary substructure.

For sliding points, the fastener (rivet, screw) is set in a slot; fixed points are formed by precisely fixing a fastener into a corresponding round hole.

## Ceiling cladding / overhead installation

According to the national technical approval, TONALITY facade tiles can also be used as ceiling cladding (overhead installation), when used with the base clinch rail system (BAS) and adaptive system (ADS). This requires mechanical protection against facade tile

slippage from hanger profiles. This can be carried out for example, by optionally using the anti-lift retaining clip already integrated in the joint profile.

# Design basics

## Base clinch rail system (BAS)

TONALITY BAS profiles must be screwed to T-aluminium 70 x 50 x 2 mm support profiles made of EN AW 6060 aluminium alloy in accordance with DIN EN 755-2, material corresponding to T66, in accordance with the national technical approval, at a spacing equal to or twice the nominal tile height. The proof of stability for the support profile must be verified by static engineering for the specific construction project. The connection between base clinch rail system and support profile on the reverse must be provided using drill screws

JT9-4-4.8x19 or other approved means of fixing, verified by static engineering for the specific construction. Two screws must be set symmetrically at each connection point. Butt joints of profiles must be at least 6 mm. Butt joints in the system substructure must not be spanned by facade tiles.

Alternatively, aluminium/stainless steel rivets – K9.5 can be used according to the national technical approval.

## ADS – adaptive system

### Installation of vertical profile

TONALITY vertical profiles must be screwed or riveted to the previously installed substructure in accordance with the construction's static engineering requirements. The separation between connections and the type of connection must be implemented in accordance with the construction's static requirements. Technically approved connecting elements must be used in all cases. As already described for the substructure, appropriate butt joint formation for absorbing thermal linear expansion of profiles must be built in whilst installing the profiles. Make sure that butt joint formation required in the primary substructure (T-profile) and the TONALITY ADS hanger profile are implemented in the same vertical grid. When arranging several hanger profiles above one other, the length of the hanger profiles and the distance between fixed points of two consecutive hanger profiles must not exceed 2.80 m. The butt joints of facade tiles and hanger profiles must be at least 6 mm. Corresponding butt joints must be planned when cutting to size on site. Hanger profile butt joints must not be spanned by facade tiles. When installing vertical ADS hanger

profiles on a horizontal primary substructure, ADS hanger profile cantilevers must not exceed 150 mm maximum, in order to avoid an apparent visual misalignment of the cladding in the region of the butt joint due to hanger profiles curving outwards.

### Joint profile installation

To secure joint profiles, they are clamped onto the vertical profile, setting the edges on beads in the vertical profile. As a rule, they are prevented from falling out by inserting the tiles. At the same time, the tiles are pressed against the vertical profile by the joint profile in order to avoid noise being generated on the tile under wind loading. When inserting the joint profile, attention must be paid to the height constraints of the system profile and the joint profiles must be inserted in such a way that achieves the required clamping effect for the tiles. With ceiling cladding, it is advisable for the joint profile to be screwed to the vertical profile to ensure that any horizontal displacement of the joint profile and installed tiles is prevented. The joint profile must not span the 6 mm vertical profile butt joint beyond the grid.

## Ordering instructions

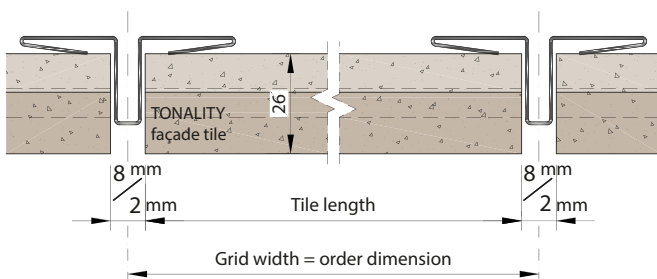

Example: Axial dimension = 450 mm; joint width = 8 mm  
 Cut length = 450 mm – 8.0 mm = 442 mm

The cut length (tile length) is calculated as grid length (axial dimension) minus the joint width selected (standard joint 8 mm or fine joint 2 mm).

- To avoid interruptions during installation due to breakage or waste, we recommend adding an allowance of approx. 5% (5 - 15%, depending on the construction) to the number required.
- When ordering, we recommend consideration of a reasonable number of spare tiles for storage by the owner of the building.
- An unambiguous and binding order can be placed using the electronic order form available from our customer service team.



## Disposal of waste

Facade tiles can be disposed of as building and demolition waste under waste code number 17.01.03 (tiles, bricks and ceramics in accordance with the European waste catalogue). By sorting materials, it is possible to direct them to high-quality recycling. The

aluminium profiles can be disposed of as a recyclable material or as building and demolition waste under waste code number 17.04.02 (aluminium in accordance with the European waste catalogue).

## Storage and transport

Facade tiles and substructure are packed on pallets and wrapped with shrink film and edge protection to protect against damage or contamination. Despite the above appropriate care should be taken when unloading and moving.

## Cutting

We recommend wet cutting machines like those used by tile fixers to cut large format and thick porcelain stoneware. The following recommendation is an example for this:

Dahm D2 ceramic and stone cutting machine Item No. 30025

Dahm DNS 1 diamond cutting blade Item No. 50152

Source address:

Karl Dahm & Partner GmbH

Professional tools for tiles and natural stone

Ludwigstrasse 5, 83358 Seebruck, Germany

Telephone +49 (0) 8667-878-0, Fax +49 (0) 8667-878-200

Internet: [www.dahm-werkzeug.de](http://www.dahm-werkzeug.de)

Warning: If longitudinal cuts of more than 1,500 mm must be made, then use an appropriate machine with a longer cutting table.

## Cleaning fine dust from tiles

Cutting residues must be removed from the tiles after cutting tiles on site. This can be done using a supply of ample clean water. Only clean tiles should be installed. If there is still fine dust on the tiles in the form of a grey haze following installation, this can be wiped off

dry tiles using a dry microfiber cloth (e.g. from Vileda). It is important here that the tile and cloth are dry, so no residue remains on the tile. However, if concrete or mortar residues remain on the tile, this can be removed using a cement residue remover.

## Tiles with graffiti protection – cleaning contamination from tiles

Tiles in the TONALITY NATUR, NUANCE, SIENA and NOBLESSE COLOR product series have durable, effective graffiti protection. This is directly fired in during the KERALIS process. The protective effect is present from day one, and so also during construction phase. Unlike conventional systems, no refreshing or renewal of the protection is required. TONALITY graffiti protection lasts for the entire life of the product.

With conventional systems, graffiti protection must be applied retroactively. It usually involves a wax-like coating that alters the gloss

level of the tiles and often leads to spots forming. The coating also loses its effectiveness after approx. 3 years and must be reapplied.

TONALITY graffiti protection does not need to be renewed. Should contamination occur through graffiti, it can be "wiped away". We recommend a mild solution of alcohol for this, or a graffiti remover such as P3 Scribex 400 from the company Henkel.

## Colour overview

### TONALITY NATUR



70017 Toscana



70002 Beige

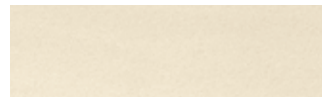

70024 Cream light



70015 Pearl grey



70010 Flint grey



70021 Umbra grey

### TONALITY NUANCE



70020 Brick red (finished surface)



70006 Dark red



70011 Copper red



70009 Bright red

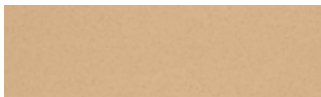

70016 Sand

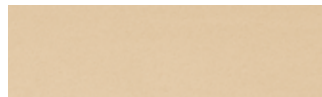

70004 Cream

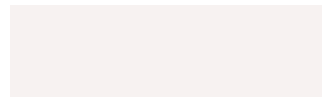

70018 White matt

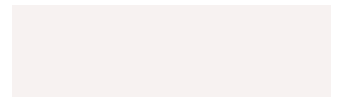

70022 White glossy

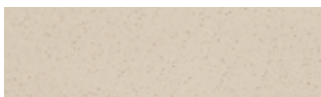

70007 Eggshell



70013 Light grey



70008 Bright grey



70014 Middle grey



70005 Dark grey



70001 Anthracite



70025 Black matt



70023 Black glossy

### TONALITY SIENA



70100 Anthracite



70102 Red





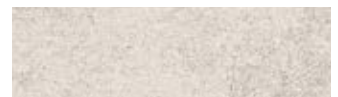























70103 Beige



70101 White



## TONALITY NOBLESSE COLOR

			
70355 - BL1	70356 - BL2	70357 - BL3	70358 - BL4
			
70380 - GR1	70381 - GR2	70382 - GR3	70383 - GR4
			
70370 - TU1	70371 - TU2	70372 - TU3	
			
70390 - VI1	70391 - VI2	70392 - VI3	
			
70365 - GE1	70366 - GE2	70375 - OK1	70376 - OK2
			
70350 - CR1	70351 - CR2	70352 - CR3	
			
70360 - OR1	70361 - OR2	70385 - R01	70386 - R02
			
70340 - BR1	70341 - BR2		



Integrated graffiti protection is available for all colours of the TONALITY NATUR, NUANCE, SIENA and NOBLESSE COLOR series.

Further colours and finishes on request.

## TONALITY BRICK RED



70019 Brick red (natural)

## Quality made in Germany



**TONALITY GmbH**  
In der Mark 100 · 56414 Weroth, Germany  
Tel: +49 6435 90999-0 · [info@tonality-facades.de](mailto:info@tonality-facades.de)  
[www.tonality-facades.de](http://www.tonality-facades.de)