

**INSTRUCTION
GUIDE**







Table of contents

Product properties

Overview product properties	5
Design advantages	6 - 7
Installation advantages	8 - 9

Working with Rockpanel

Packaging, transport and storage	10
Get started with Rockpanel boards	11

Sub-construction

Ventilated facade	12 - 14
Alternative applications	15
Sub-construction materials	16 - 17

Fixing

Fixing to timber sub-construction	18 - 20
Fixing to aluminium sub-construction	21
Fixing to steel sub-construction	22 - 23
Tension-free fixing	24 - 25
Fixing guidelines	26 - 43

Board joints, corner solutions and bending

Board joints	44
Corner solutions	44
Bending and curving	45
Guidelines seamless installation	45

Details

Facade	48 - 62
Roofline	63 - 64
Detailing	65



Overview product properties

Properties		Value	Unit	Standard
Mechanical				
Modulus of elasticity	A2	≥ 4740	N/mm ²	EN 310
Characteristic bending strength f_{05}	A2	≥ 25.5	N/mm ²	EN 310 & EN 1058
Modulus of elasticity	Durable	4015	N/mm ²	EN 310
Characteristic bending strength f_{05}	Durable	≥ 27	N/mm ²	EN 310 & EN 1058
Modulus of elasticity	Uni	3567	N/mm ²	EN 310
Characteristic bending strength f_{05}	Uni	≥ 24	N/mm ²	EN 310 & EN 1058
Modulus of elasticity	Ply	3065	N/mm ²	EN 310
Characteristic bending strength f_{05}	Ply	≥ 15	N/mm ²	EN 310 & EN 1058
Optical				
Colour stability (5000 hours; Xenon test)	Rockpanel Colours / Lines ²	3-4 or better	Greyscales	EN 20105-A02
	Rockpanel Colours (PP) Woods / Stones / Metals / Chameleon / Premium	4 or better	Greyscales	EN 20105-A02
	Rockpanel Uni	3 or better		
Fire				
Fire classification	Euroclass B-s2,d0 (Durable/Ply/Uni)* Euroclass A2-s1,d0 (A2)*			EN 13501-1
Physical				
Nominal density	A2	1250	kg/m ³	EN 323
	Durable	1050	kg/m ³	
	Uni	1050	kg/m ³	
	Ply	1000	kg/m ³	
Nominal mass of surface	A2	9 mm: 11.25	kg/m ²	
	Premium A2	11 mm: 13.75	kg/m ²	
	Durable	6 mm: 6.3	kg/m ²	
	Durable	8 mm: 8.4	kg/m ²	
	Uni	6 mm: 6.3	kg/m ²	
	Ply	8 mm: 8	kg/m ²	
Vapour permeability S_d at 23°C and 85% RH	Rockpanel Colours	1.8	m	EN-ISO 12572
	Rockpanel with ProtectPlus **	3.5	m	
Dimensional stability				
Dimension stability arising from changes in temperature	A2	9.7	mm/m·K	EN 438-2
	Durable	10.5	mm/m·K	
	Uni	10.5	mm/m·K	
	Ply	9.7	mm/m·K	
Expansion due to moisture between conditions of 23°C/50% RH and 23°C/95% RH	A2	0.206	mm/m	EN 438-2
	Durable	0.302	mm/m	
	Uni	0.303	mm/m	
	Ply	0.241	mm/m (after 4 days)	

* Depending on the sub-construction. For more information please contact us.

** With the exception of Rockpanel Metals Aluminium White and Aluminium Grey and all Rockpanel Chameleon boards (S_d value > 3,5).

Product properties

Unique by nature

The sustainable board material Rockpanel is - like all ROCKWOOL products - produced from the natural raw material basalt. This is the volcanic rock from which all ROCKWOOL products derive their unique properties.

Design advantages



Colour stable

Rockpanel boards are treated with a water-based coating that maintains their appearance, colour and finish for years to come. The table below shows the performance of the Rockpanel boards after a weathering test of 3000 and 5000 hours. This represents the weathering on a vertical south-facing facade.

The ProtectPlus coating is applied as standard on Rockpanel Premium, Woods, Stones, Metals and Chameleon.

Colour stability			
Product	Value 3000 hours	Value 5000 hours	Unit
Premium	4-5	4 or better	Greyscale
Colours	4	3-4 or better	Greyscale
Colours (ProtectPlus)	4-5	4 or better	Greyscale
Woods	4-5	4 or better	Greyscale
Stones	4-5	4 or better	Greyscale
Metals	4-5	4 or better	Greyscale
Chameleon	4-5	4 or better	Greyscale
Lines ²	4	3-4 or better	Greyscale
Uni	-	3 or better	Greyscale

Standard: EN 20105-A02



Bending and curving

The boards can easily be curved and bent in any form you require, supporting your freedom of expression and creativity. The advised minimum bending radius is determined by the bending strength of Rockpanel boards, assuming that the board is bent lengthwise.

See page 45 for more information.



Dimensionally stable

Dimensional stability, or resistance to changes in length and width, is determined by a material's tendency to expand as a result of temperature and/or moisture (moisture absorption). The unique composition of Rockpanel means that the boards are virtually immune to dimensional change caused by temperature or relative humidity.

See page 45 for guidelines on seamless installation.

Horizontal and vertical joints

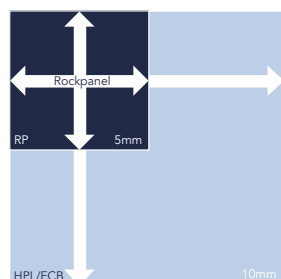

Linear elongation due to temperature fluctuation

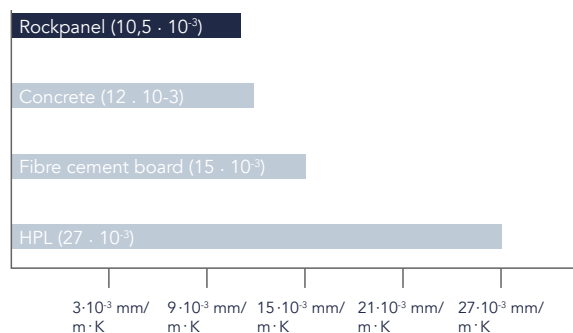

Fire safety

Rockpanel board material has been tested extensively and is classified as a fire safe building material. In case of fire, the stone wool structure remains fully intact and there will be absolutely no drop formation and the risk of fire spreading is prevented.

The boards are minimum B-s2,d0 classified and are also available in A2-s1,d0.

For all medium and high rise buildings we recommend the use of our A2 grade boards (A2-s1,d0).

Check national regulations for information on fire barriers.

Product	Fire class*	Standard
Durable	B-s1,d0	EN 13501-1
A2	A2-s1,d0	EN 13501-1

* Depending on the sub-construction. For more information please contact us.



Always in matching colours

The RAL colours of Rockpanel can be matched to window frames or other building elements. Facade finishing and paintwork in compatible RAL colour can therefore give your building a smooth and seamless look.



Non-directional

The Rockpanel boards are non-directional. The appearance of the board is the same regardless of the orientation in which it is mounted. This guarantees more efficient and swifter installation since fitting is simplified and waste reduced. Therefore during processing there is no marking of installation direction required.

Please note this applies only to Rockpanel Uni, Colours, Metals and Chameleon.



A corner solution for every building

For every corner Rockpanel offers the right solution. Use a corner profile in exactly the same RAL colour, or simply touch up paint for the edges if required. For the real craftsman you can achieve a perfect corner finish using a mitre saw.

See page 44 for the possibilities.

Installation advantages



Strong and flexible

Rockpanel combines the advantages of stone and wood in one product. It is as durable as stone and can be worked as easily as wood. A curved facade can easily be installed.



Light-weight

With Rockpanel board material you can work more quickly and easily. The boards are considerably lighter than other board materials. A standard Rockpanel board weighs only 8,4 kg/m², making it easy to handle on site.

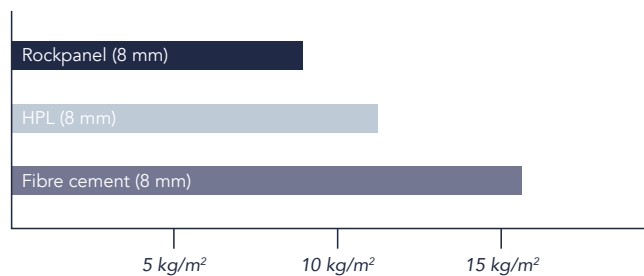

Insensitive to moisture

With Rockpanel boards moisture problems are history. Rockpanel is insensitive to moisture and temperature so does not require edge treatment. Moisture will not change the mechanical or optical properties.

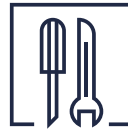

Working with standard tools

Rockpanel can be worked using standard carpentry tools. It is easier and much faster to work than other board materials. Easy to saw to size and install without pre-drilling again avoiding risks and costly site delays.



Butt joints

Rockpanel is dimensionally stable, and therefore resistant to changes in length and width arising from changes in temperature and humidity. This guarantees a sleek result without joints.

See page 45 for the conditions of seamless installation.



Detailing on the building site

With Rockpanel you can complete detailing quickly and easily. Finishing the edges to protect them from moisture is not necessary.

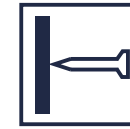

Fixing with nails

With Rockpanel you can fix the boards with nails on the building site. The discreet nail heads in a compatible RAL colour ensure a beautiful end result.



Fixing without pre-drilling

Unlike other board materials, Rockpanel boards are dimensionally stable. Pre-drilling is not required but recommended when fixing the boards on a timber frame using Rockpanel screws.

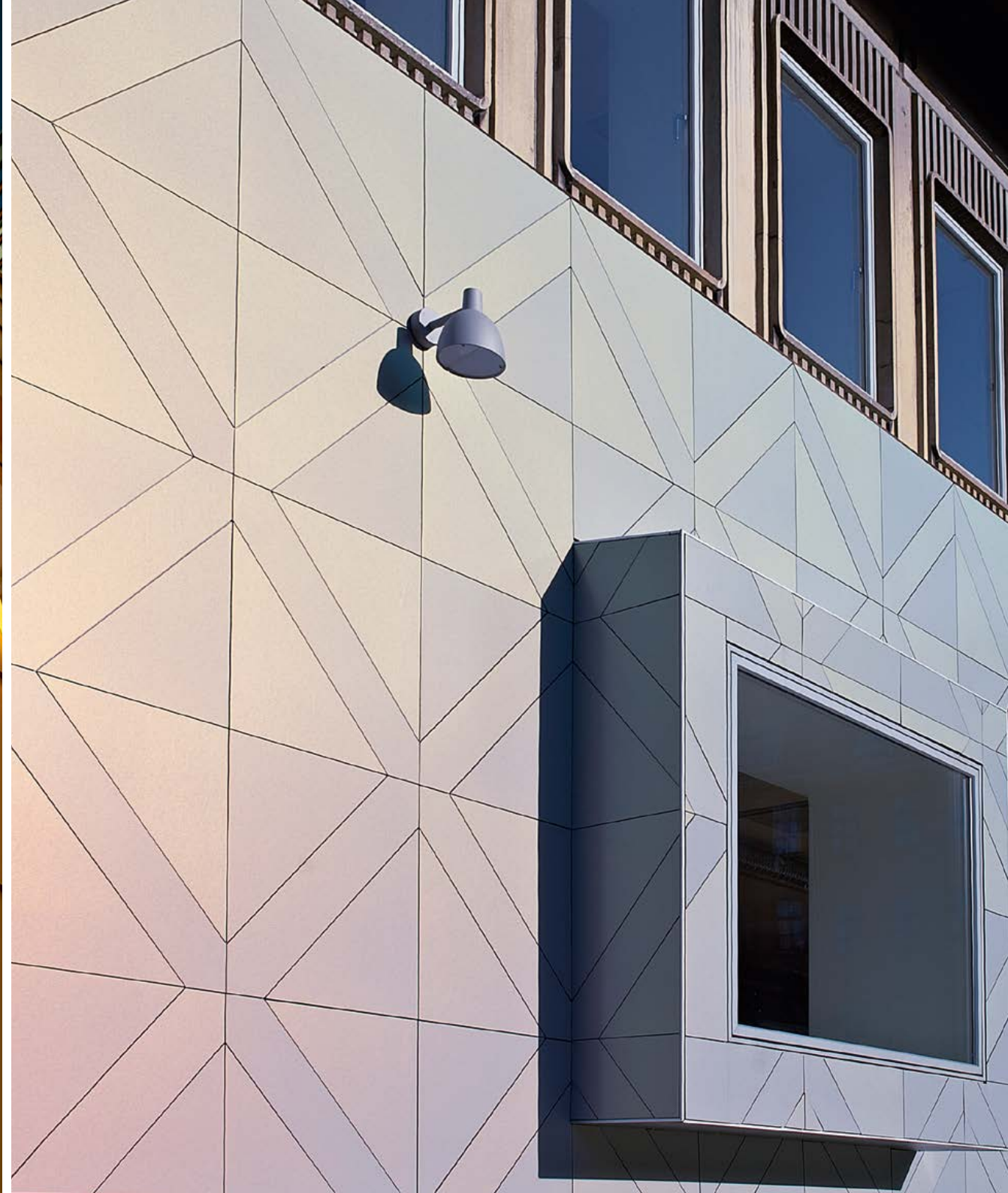

Working with Rockpanel

Packaging, transport and storage

Rockpanel is a light-weight, decorative external cladding product which weighs less than many other board materials. The products should always be handled with care by taking the following guidelines into account:

Storage in warehouse and building site

- Store the board material in dry, flat, frost-proof and protected conditions;
- Store on flat pallets and place the pallets on a level foundation. Preferably with PE-foil as an underlay;
- Make sure that the board material does not have direct contact with the floor;
- Never stack more than two pallets high;
- During storage, the board material can be more affected by moisture and night-time cooling than when installed. Before installing, the boards will need some time to allow any moisture and condensation to evaporate.

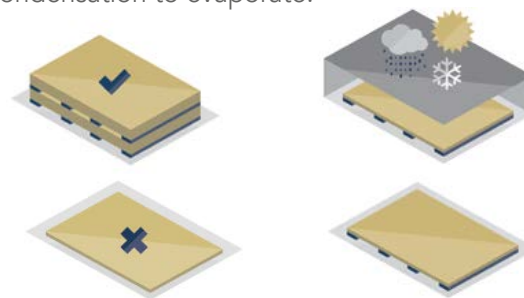

Site handling

- Individual panels must be lifted off the stack, not pulled or pushed, and carried upright;
- Protective foam membranes should be placed between the sheets again to protect the surface layer.



Protective film

- Most boards in the range are covered by a film to protect the decorative finish. Site measurements can also be marked on this film to aid the installation process. Rockpanel Natural, Rockpanel Ply, Rockpanel Lines² and Rockpanel Metals (Aluminium White and Aluminium Grey) are delivered without protective film. Handling of these boards needs extra attention.
- Remove the protective film:
 - after mounting, if attaching mechanically with screws or manual nailing;
 - before priming the board for adhesive bonding;
 - before installing when using a pneumatic hammer.

Get started with Rockpanel boards

Working with Rockpanel boards

The light-weight of Rockpanel boards allow for easy and quick installation. It also does not require any special tooling.

Safety guidelines

- Use a dust mask (type P2).
- Use standard safety spectacles to protect the eyes from dust.
- Wear gloves during sawing.

For additional information see the 'Health and safety' documentation on our website.

Indoor sawing

Use dust-reducing sawing equipment in combination with an extraction hood in a well-ventilated room.

Outdoor sawing

- Position the saw installation so that the wind blows away any dust from the sawing.
- Use dust-reducing sawing equipment if possible.

Always immediately clean the dust after cutting and drilling.

Equipment



Hand saw, e.g. a hard point saw.



Circular saw, e.g. a fine-toothed Widia/Tungsten Carbide saw blade, for example a blade with 48 teeth and a diameter of 300 mm.



Fretsaw, e.g. a fine-toothed saw blade for metal or a saw blade with tungsten coating.



Pre-drilling can be done with a HSS-steeldrill.

Sawing

Standard tools can be used for sawing Rockpanel boards or making penetrations and cut-outs in the board material. In general the boards should be sawn with the decorative side facing upwards and with the protective film still in place. It is advised that when cutting boards with a hand-held circular saw the decorative side is facing downwards. Ensure that there is a clean, smooth surface for doing this.

Drilling

- Pre-drilling of Rockpanel boards is not required but recommended. Screw holes (Ø 3.2 mm) or holes for nailing (Ø 2.5 mm) can be pre-drilled with a HSS-steeldrill.
- With rivets, fixed anchorages are advised to be drilled at Ø 5.2 mm and a sliding attachment with Ø 8 mm. Predrilling can be done with a HSS-steel-drill.
- When fixing Rockpanel Lines² 10 mm Rockpanel recommends the use of flat headed screws or manual nailing with ring shank nails. When using 2.1/2.3 x 27 mm ring shank nails pre-drilling to Ø 2 mm is recommended. When using 3.5 x 30 mm stainless steel flat headed screws, pre-drilling to Ø 3.5 mm is recommended and also drilling to countersink the flathead.

No edge finishing

- Protecting sawn edges from moisture is not needed with Rockpanel boards.
- Chamfering is easy using the reverse (non-decorative) side of a leftover Rockpanel strip to lightly sand and edge.
- If required for aesthetic reasons the side edges can be painted in a corresponding RAL/NCS colour. Without finishing the edges naturally age within several months to a grey-brown colour.

Sub- construction

Ventilated facade

Rockpanel boards are applied as a ventilated facade cladding. A ventilated facade is a secondary defence system, also known as rainscreen. Ventilated facades built with Rockpanel boards counterbalance the effects of moisture, help to lower energy consumption both during summer and winter time, and make a positive contribution to healthy, safe and enjoyable living places thanks to their aesthetic design together with fantastic climatic and fire safety properties.

Ventilated facades, whether they are with open or closed construction, need to have sufficient ventilation openings. For proper ventilation, the sub-construction must have ventilation openings of at least 5000 mm² per meter of the length. The openings must be made at both the top and bottom of the cladding. The size of the openings should be between 5 and 10 mm wide. It is advised to apply the anti-insect mesh to prevent insects and rodents from entering the ventilation cavity. The depth of the ventilated cavity should be at least 20 mm. In case of using timber battens the cavity needs to be 28 mm.

Open facade

The open system works with open joints, whereby a small amount of rainwater may enter the cavity behind the panels. Any penetrating water will either drain away or be removed by the airflow in the cavity. In addition it must be ensured that the air cavities on different elevations of a building are separated from each other by cavity closers, so that there is no increase in wind load (see drawing).

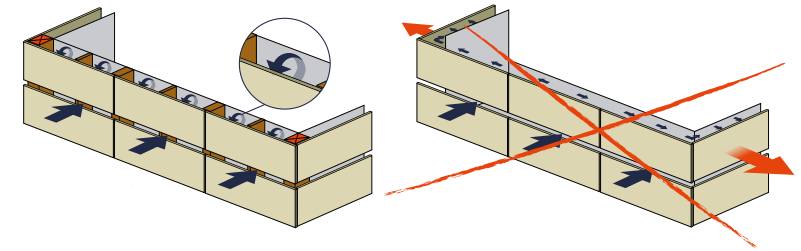

To be able to calculate the fixing distances as with open joints (which means reducing the wind load with pressure equalisation and achieving wider fixing distances), application needs to be done according the following pre-conditions:

- See drawing.
- $5 \text{ mm} \leq \text{horizontal open joints} \leq 8 \text{ mm}$.
- Open joints represent $\geq 0,10 \%$ of the total surface.
- Cavity closers should be used to prevent accumulation of wind loads (see also drawing above).
- Cavity should be at least 40 mm deep (maximum 100 mm).
- UV-resistant breathable membrane (in case of timber sub-construction).

Horizontal joints

With an open facade, the horizontal joints should have a joint of a minimum 5 mm and maximum 8 mm width.

- When using open joints in a timber construction, the structure behind the vertical batten should be protected with a breathable, water repellent and UV resistant membrane. The cavity between the Rockpanel board and the breathable membrane should be minimum 28 mm or greater. It would be beneficial to have a cavity between 40 - 100 mm to make use of pressure and to prevent penetration of excessive rainwater. For those panel systems requiring NHBC approval, a cavity of 38 mm is required.
- With an aluminium construction Rockpanel recommends a cavity depth of 40 - 100 mm. The insulation should comply with the standard BS-EN 13162 e.g. ROCKWOOL Rainscreen Duoslab.

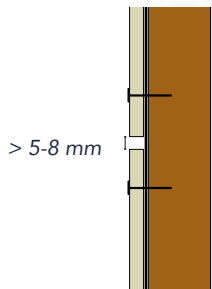

Timber sub-construction,
open horizontal joint

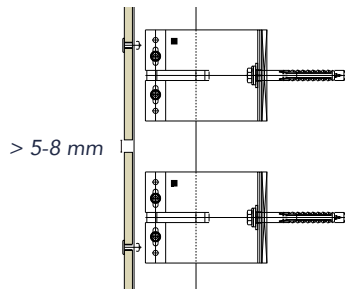

Aluminium sub-construction,
open horizontal joint

Vertical joints

The vertical joints are automatically closed by the backing of the vertical sub-construction. To ensure the durability of the timber, the vertical battens must be well protected against rain water. This can be done with a UV- and weather-resistant EPDM gasket that is 15 mm wider on both sides than the framework. It can also be done with a strip of Rockpanel, which acts as gasket to protect the battens.



Timber sub-construction,
vertical joint solution with
EPDM gasket

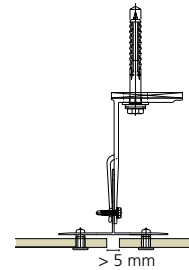

Aluminium sub-construction,
vertical joint solution

Sub- construction

Closed facade

Horizontal joints

For a closed facade the horizontal joints are closed with a profile, usually a chair or nose profile (semi-closed). Thus the rainwater is drained off as much as possible on the outer side of the cladding. The supporting structure must be ventilated. For example retaining a 20 mm cavity width behind the cladding and 5 mm continuous opening (or equivalent slots) at top and bottom. Further, ventilation must be provided in vertical runs exceeding 20 m. For those panel systems requiring NHBC approval, a cavity of 38 mm is required. For timber sub-construction a cavity of 28 mm is required, in regards to the minimal thickness of the batten.

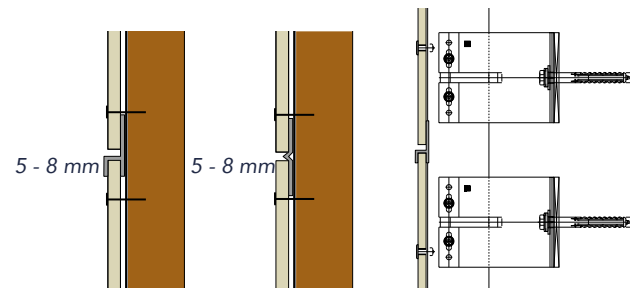

Timber sub-construction with closed (left) and semi-closed (right) horizontal joint

Aluminium sub-construction with closed horizontal joint

Vertical joints

The vertical joints are automatically closed by the backing of the vertical sub-construction. To ensure the durability of the timber, the vertical battens must be well protected against rain water. This can be done with a UV- and weather-resistant EPDM gasket or a strip of Rockpanel. With a closed joint, the gasket does not need to protrude.

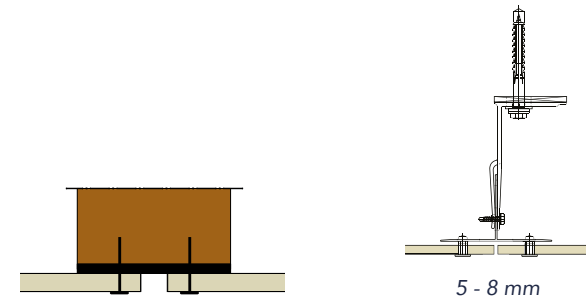

Timber sub-construction, vertical joint solution with EPDM gasket

Aluminium sub-construction, vertical joint solution

Alternative applications

Thanks to its unique characteristics and the vapour-open structure of Rockpanel Colours (without a ProtectPlus layer) this product can be used in specific situations in non-ventilated structures. In situations where the pre-conditions can easily be fulfilled, for example such as infill panels and dormers, the absence of a cavity can allow for thicker insulation which leads to a lower U-value.

See page 65 for technical detailing.

Pre-conditions for non-ventilated applications

- interior climate with a maximum vapour pressure of 1320 Pa (normal housing and office buildings i.e. no swimming pools or factories);
 - the sum of the S_{d} -values of the materials on the inside of the structure down to the insulation should add up to at least 10 m, this value can be achieved with a 0.15 mm thick PE-membrane as vapour barrier and drywall;
 - the sum of the S_{d} -values of the materials on the outside of the structure down to the insulation should add up to less than 2.5 m;
 - the inside of the structure should be airtight so that no warm air, containing moisture, can penetrate through the structure;
 - the attachments of the boards to the structure should be watertight, so that no rainwater or cleaning water can get behind the cladding. This means that horizontal joints between the Rockpanel boards are not allowed. Vertical joints can be applied but should abut at a timber batten covered with a 3 mm x 60 mm soft adhesive EPDM foam gasket;
 - can be applied on small surfaces and as infill panels;
- only Rockpanel Colours without ProtectPlus can be used in this application. The S_{d} -value from Rockpanel Colours without ProtectPlus is 1.8 m.

If you are unsure whether the construction meets these conditions, please contact Rockpanel: www.rockpanel.co.uk/contact.

Sub- construction

Sub-construction materials

Rockpanel boards can be applied to sub-constructions made of timber, aluminium or steel. For detailed information about sub-construction materials, please consult the European Technical Assessment (ETA) of the relevant Rockpanel product and your sub-construction supplier.

Timber sub-construction

Timber stud walls and timber battens fixed to masonry walls should be constructed in accordance with BS EN 1995-1-1 and preservative treated in accordance with EN 335 and BS 8417. Studding and framing should be adequately supported by noggings to ensure rigidity. Where timber stud walls or battens are treated with cuprous preservatives, care must be taken to ensure that sufficient time is allowed for the preservative to properly condition before the cladding is fixed.

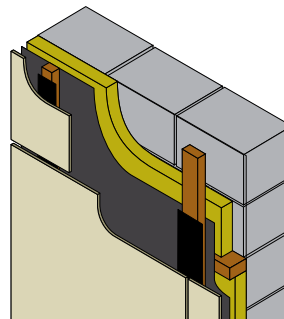

Aluminium sub-construction

When Rockpanel boards are applied to aluminium sub-construction the following requirements should be met:

- The aluminium alloy is AW-6060 according to BS EN 755-2:
 - $R_m/R_{p0,2}$ value is 170/140 for profile T6
 - $R_m/R_{p0,2}$ value is 195/150 for profile T66
- The minimum thickness of the profile is 1.5 mm.

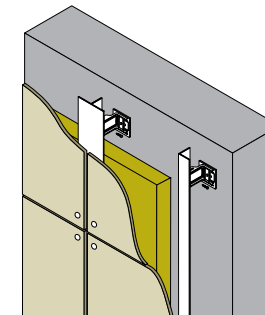

Steel sub-construction

The minimum thickness of the vertical steel profiles is either 1.0 mm (steel quality is S320GD +Z EN 10346 number 1.0250, or equivalent for cold forming), or 1.5 mm (steel quality EN 10025-2:2004 S235JR number 1.0038).

The minimum coating thickness (Z or ZA) is determined by the corrosion rate (amount of corrosion loss in thickness per year) which depends on the specific outdoor atmospheric environment. The Zinc Life Time Predictor can be used to calculate the Corrosion Rate in $\mu\text{m}/\text{y}$ for a Z coating: <http://www.galvinfo.com:8080/zclp/> [copyright The International Zinc association]. The coating designation (classification which determines the coating mass) shall be agreed between the contractor and the building owner. Alternatively, a hot dip galvanized coating according to EN ISO 1461 can be used.

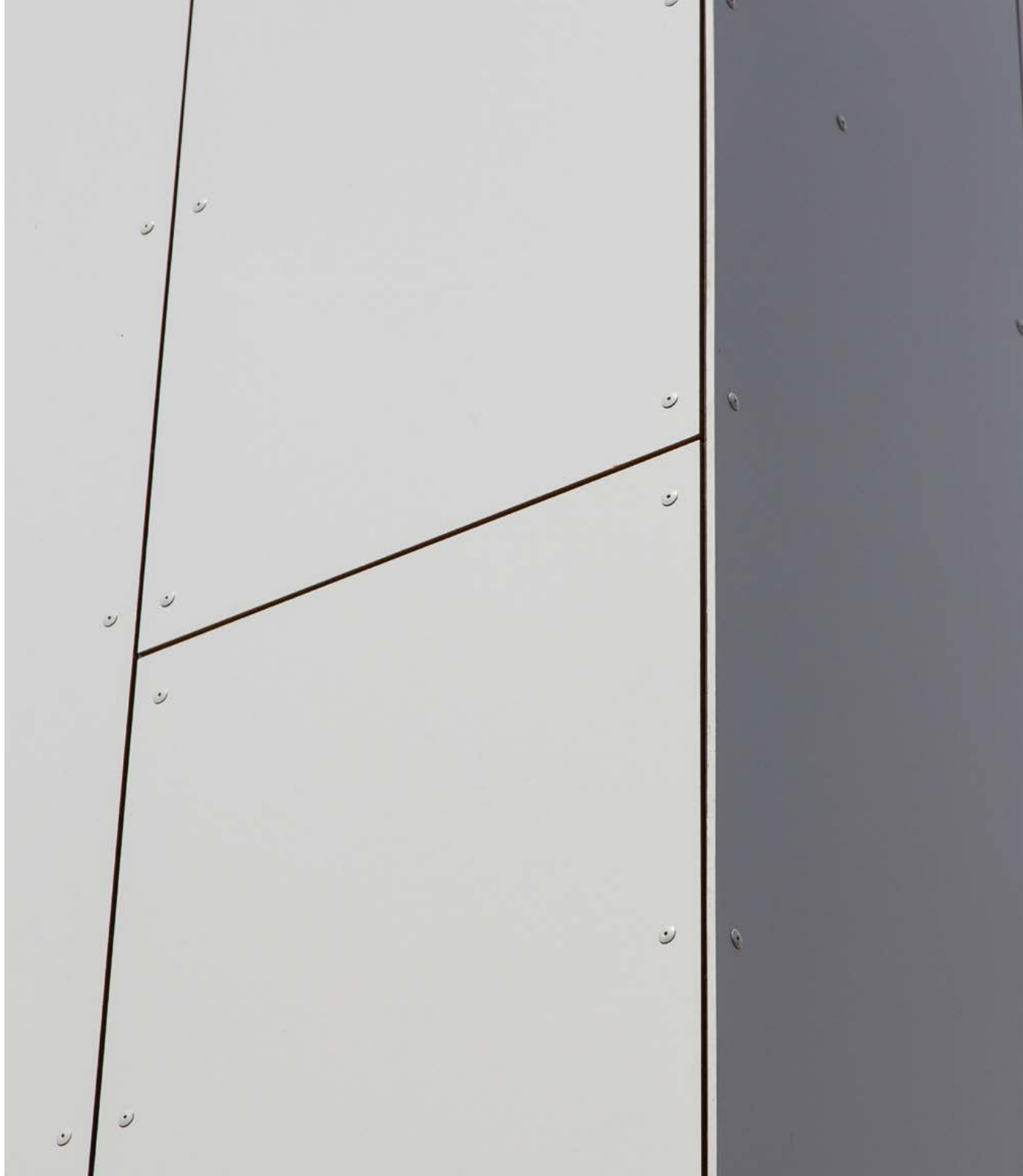
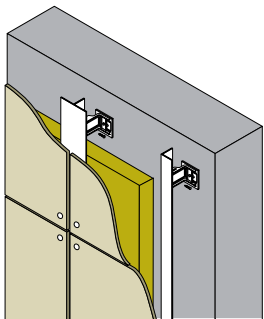

Fixing

Rockpanel can be installed with a broad range of fixings; nails, rivets, screws as well as a certified fire safe and invisible concealed fixing system (Euroclass A2-s1,d0) and adhesive system (Euroclass B-s2,d0). All are suitable and mechanically tested to be applied in combination with our board material.

Always ensure with the fixings supplier the suitability of their fixings to meet the technical requirements of Rockpanel as documented in the Declaration of Performance (DoP). Always check that fixings are suitable for the design and its associated performance requirements. It is further recommended to use only coloured fixings with a durable finish. Working with fixings from other manufacturers should be carried out according to their recommendations, their supervision.

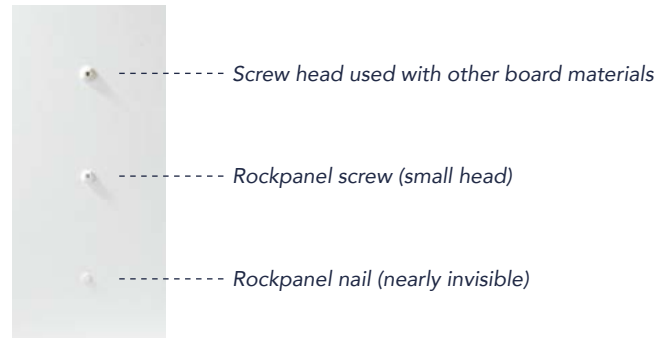

Fastening Rockpanel boards to timber sub-construction is carried out with:

- Mechanical fixings: corrosion resistant nails and screws;
- Rockpanel EasyFix clip is used for a ship lap construction
- Special nails and screws are used for our tongue-and -groove panels Lines² 10 mm
- Adhesive installation system (with an intermediate Rockpanel strip with specified finish)

Fastening to aluminium sub-construction is carried out with:

- Corrosion resistant rivets for aluminium
- Adhesive installation system
- Concealed fixing

Fastening to steel sub-construction is carried out with:

- Corrosion resistant rivets for steel
- Screws for steel

Mechanical fasteners, gaskets, adhesives with primers, strips for bonding, and sub-construction profiles are specified by the ETA-holder. For more information see the product data sheet or consult the appropriate ETA, available on our website.

Fixing to timber sub-construction

Mechanical fixing to timber

Mechanical fixing to timber can be carried out with:

- Rockpanel ring shank nails (stainless steel material number 1.4401 or 1.4578) 2.7/2.9 x 32 mm (flat-top).
- Rockpanel High Performance nails (stainless steel material number 1.4401 or 1.4578) 2.7/3.1 x 35 mm (flat top)
- Rockpanel Torx screws (stainless steel material number 1.4401 or 1.4578) 4.5 x 35 mm. Nail heads in the same RAL colour combine perfectly with the RAL colour of the board material.

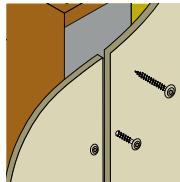
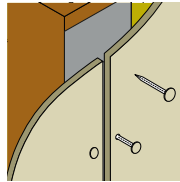

Screwing

Rockpanel board material can be fixed mechanically with nails or screws. With a timber subframe and mechanical fastening with screws, Pre-drilling of the Rockpanel boards is not required but recommended. Screw holes (Ø 3.2 mm) can be pre-drilled with a HSS-steeldrill.

The boards can be mechanically installed on the construction site.



Screw Ø 9.6 mm (head diameter)

Nailing

Rockpanel nails can be attached with either a nylon hammer or nail gun. Pre-drilling is not required but recommended. Holes for nailing holes (Ø 2.5 mm) can be pre-drilled with a HSS-steeldrill.

For a perfect match to the board material, the nail and screw heads can be provided with a RAL/NCS colour coating.

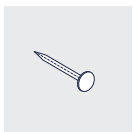

Nail Ø 6.0 mm (head diameter)

EasyFix Clip; for a ship lap construction

Rockpanel has developed a secret fixing system for cladding boards in 8 mm using a mousing spacer called Rockpanel EasyFix. The EasyFix clip allows a simple and stress free assembly by acting as a guide to locate the screw fixings.

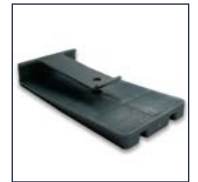
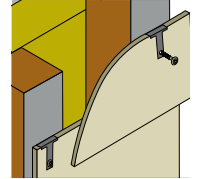

Rockpanel board sizes

Gross width (b)	Effective width (b _w)
285 - 340 mm	b - 60 mm

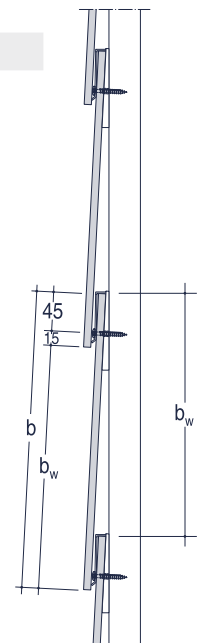

Fixing

Adhesive installation on Rockpanel strips on timber sub-construction

In collaboration with Rockpanel, Bostik has developed a firesafe (B-s2,d0) European certified adhesive system compatible with European Technical Assessments of Rockpanel, Rockpanel Tack-S. For more information, see the product data sheet or consult the appropriate ETA (e.g. for Durable ETA-07/0141). If you wish to use an alternative adhesive system, always verify that the chosen system meets the requirements for application with Rockpanel. If using another adhesive system, the adhesive supplier becomes responsible for certification and guarantee. The quality of the adhesive installation is partly determined by the weather conditions during application. For more information refer to the adhesive supplier.

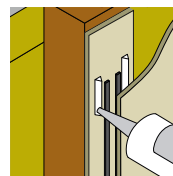

Fixing Rockpanel Lines²

Rockpanel Lines² are tongue-and-groove cladding boards suitable for horizontal application in ventilated constructions. The panels are available in a small (S) and an extra wide (XL) version. The thickness available is 10 mm. Rockpanel Lines² can be applied with:

- Rockpanel ring shank nails (stainless steel material number 1.4401 or 1.4578) 2.1/2.3 x 27 mm (flat-top).
- Stainless steel flat-top screws of 3.5 x 30 mm with a head diameter of Ø 6.6 mm. The tongue should be predrilled with a steel drill Ø 3.5 mm and the hole for the flat-top screw head should be sunk with a countersink bore. The top of the screw head should be level with the surface of the tongue. Tension in the mounting of the tongue can be avoided by tightening to an appropriate level and by ensuring they are driven into the batten in a true fashion.

Rockpanel Lines² 10 tongue-and-groove panels

The Lines² 10 tongue-and-groove panels can be fixed invisibly by means of Rockpanel ring shank nails or flat-top screws, which results in a traditional tongue-and-groove effect.

Type	Panel width	Working panel width
Rockpanel Lines ² S10	164 mm	146 mm
Rockpanel Lines ² XL10	295 mm	277 mm

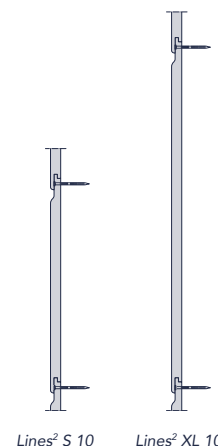

Fixing to aluminium sub-construction

Mechanical fixing to aluminium sub-construction with rivets

For the mounting of Rockpanel on aluminium load-bearing sections, Ø 14 mm AP14-50180-S flat-topped aluminium rivets can be used:

- Material EN AW-5019 in conformity with EN 755-2.
- Material number of the rivet 1.4541 in conformity with EN 10088.

When installing Rockpanel boards on aluminium load-bearing sections, fixed points, slotted holes and moving points should be applied.

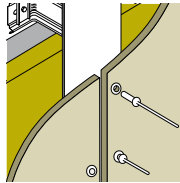

Adhesive installation on aluminium sub-construction

In collaboration with Rockpanel, Bostik has developed a fire safe (Euroclass B-s2,d0) European certified adhesive system compatible with European Technical Assessments of Rockpanel, Rockpanel Tack-S. For more information, see the product data sheet or consult the appropriate ETA (e.g. for Durable ETA-07/0141). If you wish to use an alternative adhesive system, always verify that the chosen system meets the requirements for application with Rockpanel. If using another adhesive system, the adhesive supplier becomes responsible for certification and guarantee. The quality of the adhesive installation is partly determined by the weather conditions during application. For more information, refer to the adhesive supplier.

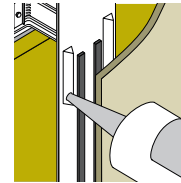

Concealed fixing to aluminium sub-construction

For mounting of Rockpanel Premium boards with invisible concealed fixing on aluminium load-bearing sections TU-S 6x13 blind fastener is used for secret fixing clip in thickness of 5 mm or TU-6x11 blind fastener for fixing clip in thickness of 3 mm. Body of blind fastener is made of stainless steel material number 1.4401 in accordance with EN 10088, with electro-galvanised carbon steel mandrel.

See ETA-18/0883 or contact Rockpanel for more information.

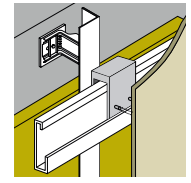

Fixing

Fixing to steel sub-construction

Mechanical fixing to steel sub-construction with rivets

For the mounting of Rockpanel on steel load-bearing sections, either EN 10088 (no 1.4578) rivets, head diameter 15 mm, body diameter 5 mm, head colour coated, or EN 10088 (no 1.4567) rivets, head diameter 14 mm, body diameter 5 mm, head colour coated, can be used. For correct fixing, a riveting tool with rivet spacer must be used.

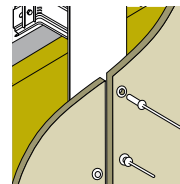

When installing Rockpanel boards on steel load-bearing sections, fixed points, slotted holes and moving points should be applied.

Mechanical fixing to steel sub-construction with screws for steel

For the mounting of Rockpanel on steel load-bearing sections, steel EJOT screws JT6-FR-3-5,5x35 and JT6-FR-3-5,5x25 can be used.

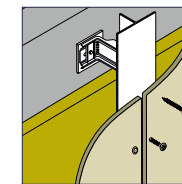

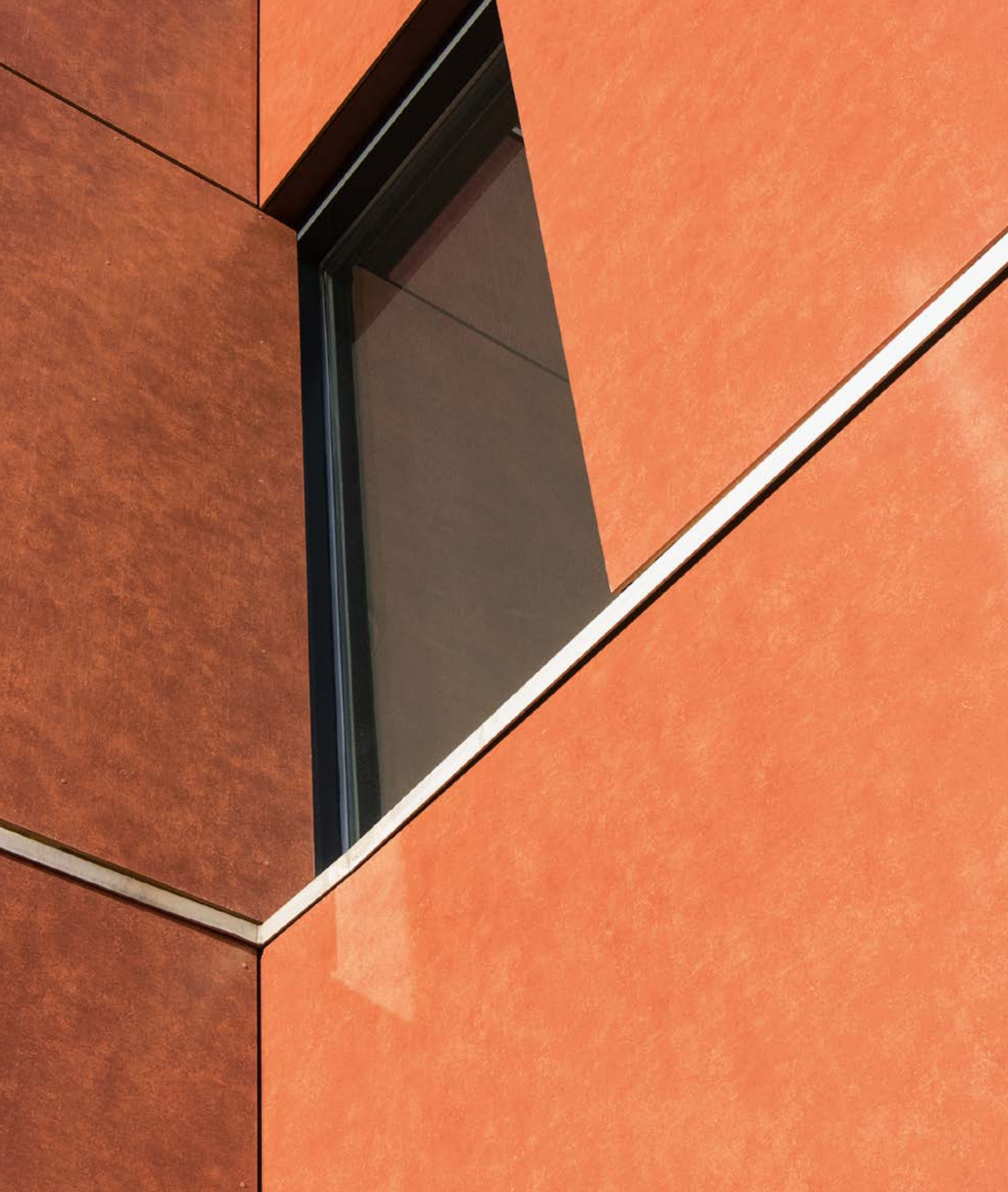

Fixing

Tension-free fixing

Cladding boards have to be mounted free from tension. In the event of tension e.g. as a result of difference in elongation between a metal sub-construction and the cladding boards, fixed points, slotted hole and moving points must be applied.

Fixed points, slotted hole and moving points can be applied in several ways. Boards can be applied with 2 fixed points and several moving points or in a combination of 1 fixed point, 1 or 2 slotted holes and several moving points. The next section will show the several possibilities.

Key fixing possibilities:



MP = Moving point, \varnothing according ETA



FP = Fixed point or fixed point created by sleeve, \varnothing according ETA



SP = Slotted point or slotted point created by sleeve, \varnothing according ETA

Principle fixed points and moving points

Each panel, no matter what size, will have 2 fixed points or 1 fixed point combined with 1 or 2 slotted points. The fixed points and slotted points support the weight of the panel and ensure the panel stays in position. All others will be moving points.

Correct application of the slotted point and moving point:

- It is important to prevent clamping of the fastener. Clamping by over-tight rivets can be prevented by the use of a rivets spacer. The rivet spacer ensures a 0,3 mm distance between the head of the rivet and the surface of the Rockpanel board by which the rivet easily can move in the moving points.
- Fasteners located in slotted holes or moving points must be able to move. Therefore it's important to position the fastener exactly in the middle of the slotted hole or moving point. To ensure the fastener is exactly in the middle a centre tool or centre drill can be used.
- Fixed points are arranged in the centre of the facade panel if possible, if possible symmetrically and are always close to a horizontal centre-line of the plate.

Tip for simple and quick installation

Holes for fixed points, moving points and slotted points can be drilled directly in the board or in the event of slotted hole created with a router. Alternatively, all holes can be drilled as moving point after which a sleeve will be used to narrow the hole and to create the fixed points or slotted points. Different sleeves are available for fixed points and slotted points. In the event of using sleeves it should be considered that the maximum distance between a fixed point and a side sleeve (sleeve used in the slotted point) is limited to 600 mm. For correct application of the sleeves a proper positioning tool should be used.

The examples below are given for a correct vertical or horizontal orientated application.

Examples by vertical orientated boards > 8 mm:

Figure 1:
Combination fixed point and slotted points

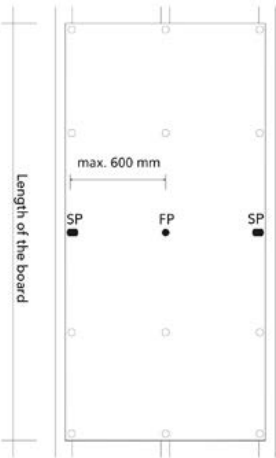
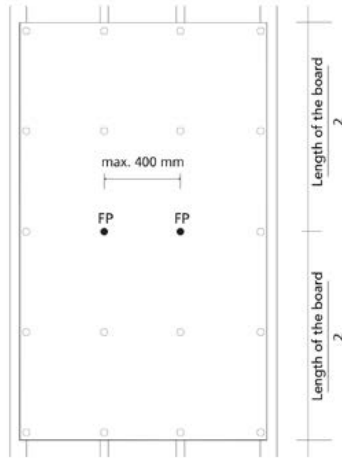

Figure 2:
Combination of 2 fixed points



Examples by horizontal orientated boards > 8 mm:

Figure 3:
Combination fixed point and slotted points in symmetric way

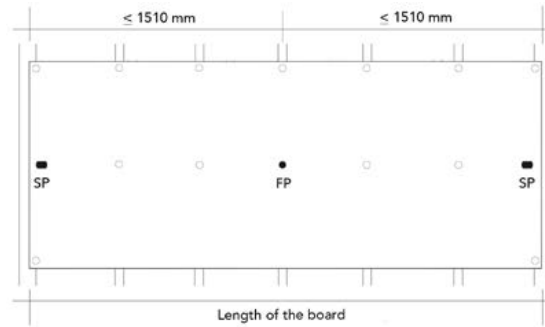

Figure 4:
Combination fixed points and slotted point in symmetric way

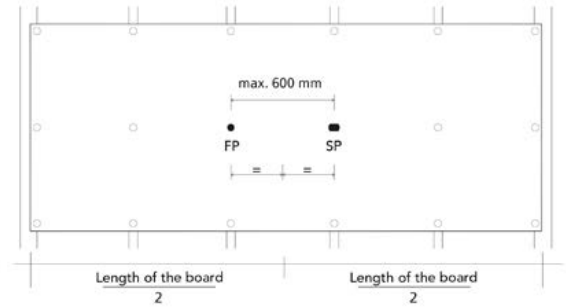
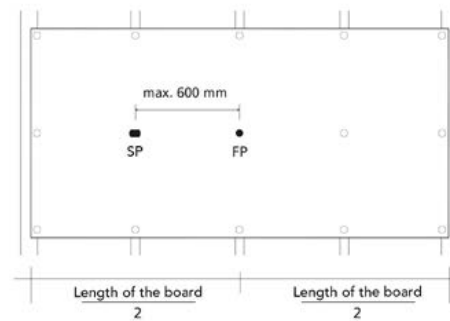

Figure 5:
Combination of fixed and slotted point in asymmetric way



Fixing

Fixing guidelines

In this section the mounting guidelines and maximum fixing distances are indicated for facade panels, tongue and groove panels and gutter trims on timber support structures and for facade elements on aluminium support structures on the basis of boundary conditions, data and material properties.

The fixing distances are shown for 6 mm, 8 mm Durable grade boards and 6 mm, 8 mm Uni grade boards. For all medium and high rise buildings, we recommend the use of our A2 grade boards (A2-s1,d0). Project specific calculations are available on request.

The fixing distances for Rockpanel Lines² tongue and groove panels give the maximum permitted building height for attachment to timber support structures.

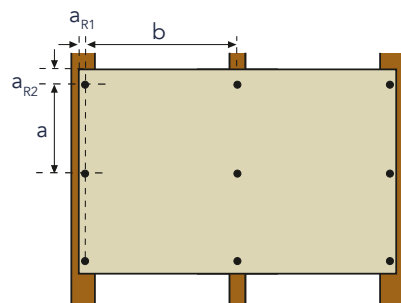

Edge distance a_{R1} (board thickness ≤ 8 mm) : 15 mm
 (board thickness ≥ 9 mm) : 20 mm
 Edge distances $a_{R2} \geq 50$ mm

Distances between fastening points

The table below shows the maximum fixing distances at a vertical timber sub-construction or aluminium sub-construction in accordance with ETA-07/0141, ETA-08/0343 for Durable boards and ETA-17/0619, ETA-17/0620 for Uni boards.

Rockpanel Durable 6 mm

Fastening system	Maximum span (b)	Maximum distance between Fasteners (a)
Rockpanel screw	400 mm	300 mm
Rockpanel ring shank nail	480 mm	300 mm

Rockpanel Durable 8 mm*

Fastening system	Maximum span (b)	Maximum distance between Fasteners (a)
Rockpanel screw	600 mm	600 mm
Rockpanel ring shank nail	600 mm	400 mm
Rivet	600 mm	600 mm

Adhesive system: The maximum span between the adhesive beads at an 8 mm board will be 600 mm (b)

* Maximum distances are not applicable for Rockpanel Natural.

Rockpanel Uni 6 mm

Fastening system	Maximum span (b)	Maximum distance between Fasteners (a)
Rockpanel screw	400 mm	300 mm
Rockpanel ring shank nail	480 mm	300 mm

Determining the fixing distances

The following steps should be followed to determine the fixing distances:

- Determine the design wind load
 - define wind zone
 - define terrain category
 - define area on the facade
 - zone A for corner area and B for middle area (take into account the rules in standard EN 1991-1-4, if unknown or facades are very small use zone A as normative value)
 - look up in the table the design wind load in kN/m²
- Determine the fixing distances
 - choose the correct table by:
 - static load absorption, for example 1-field span (b) or 2-field span (b)
 - type of board and thickness (e.g. Durable 8 mm)
 - fastening system
 - look up the preferred span - combine with the wind load of step 1: result is the fixing distance between the fasteners

Take into account local requirements.

Horizontal applications

If Rockpanel board material is used horizontally, for example in a ceiling application, the specific weight of the board must be taken into account in the calculation of the fixing distances. As a rule of thumb, the fixing distances can be multiplied by 0.75.

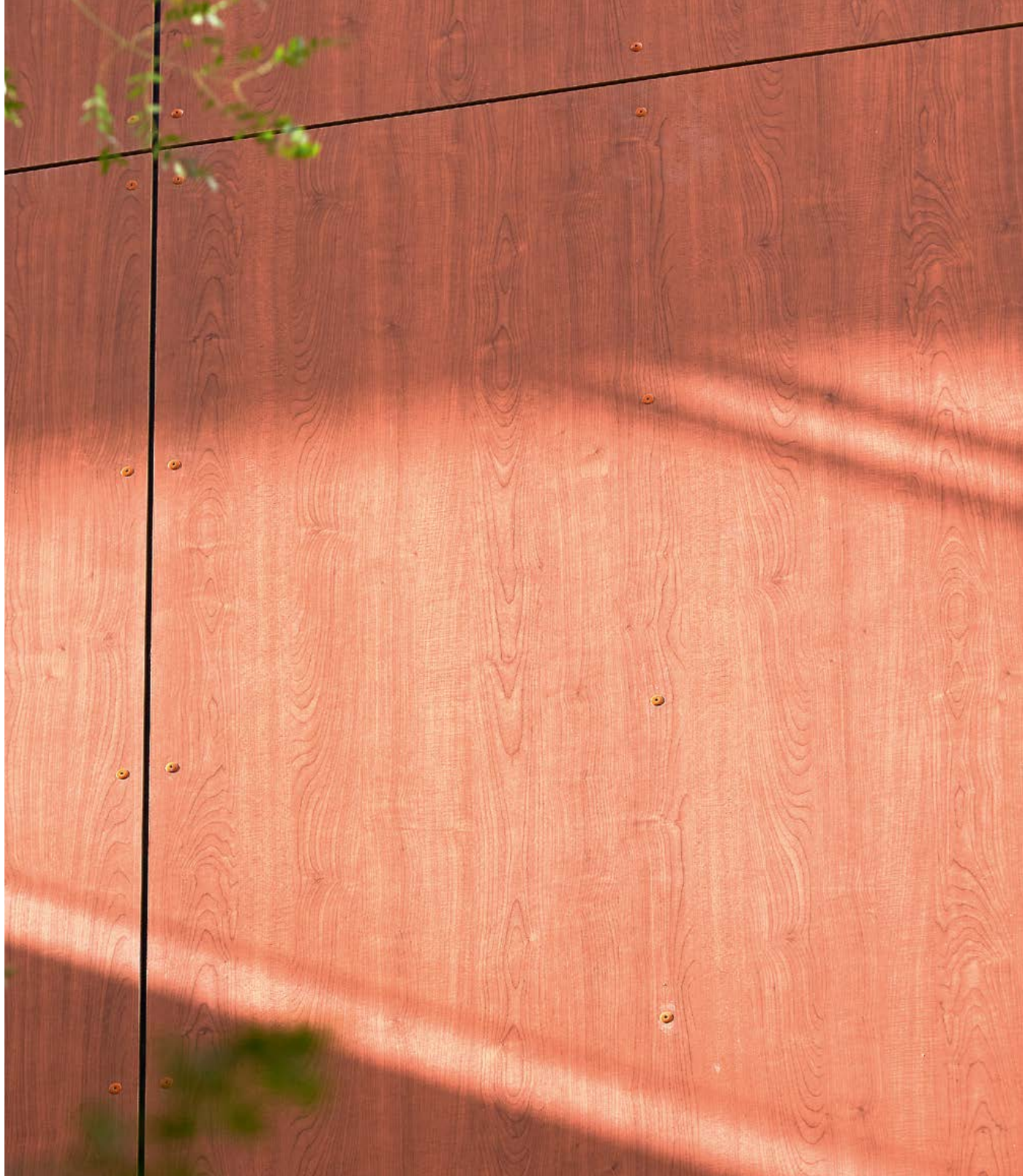

Fixing

Basic wind velocity (m/s)

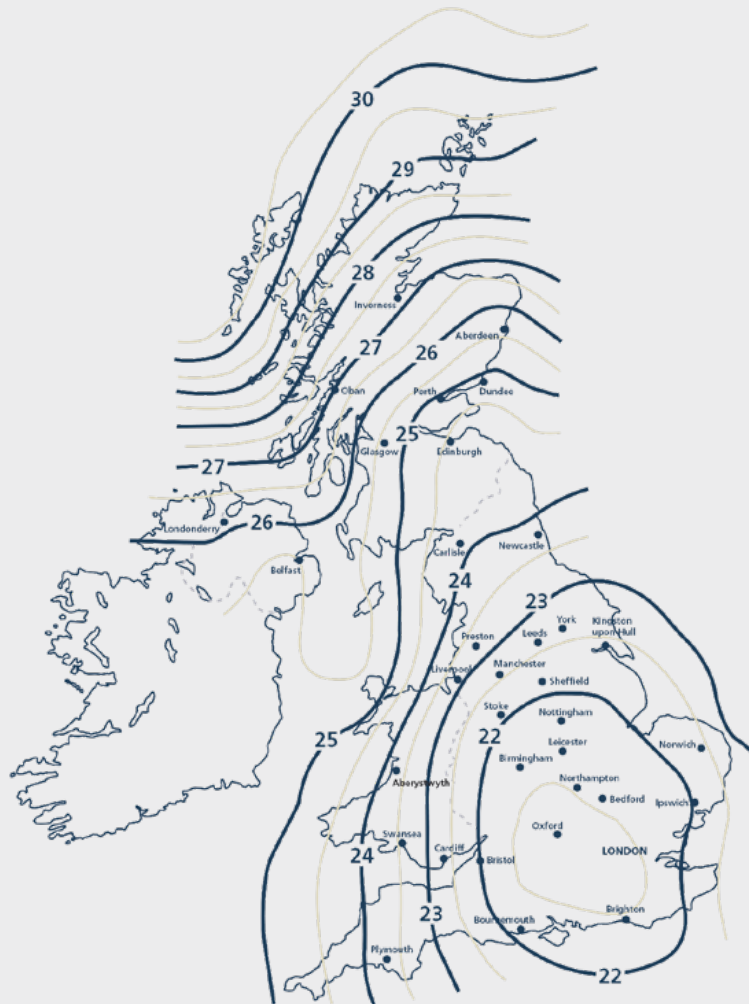

This map is an indication of the fundamental basic wind velocity according to BS-EN 1991-1-4. If you are unsure which zone the building is located please contact Rockpanel.

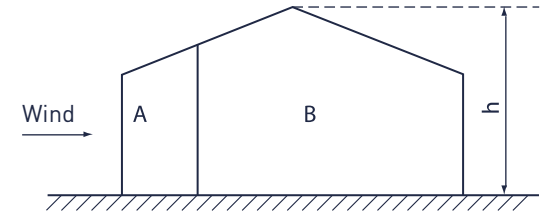

A = Corner area
B = Area between the corners
h = Total building height

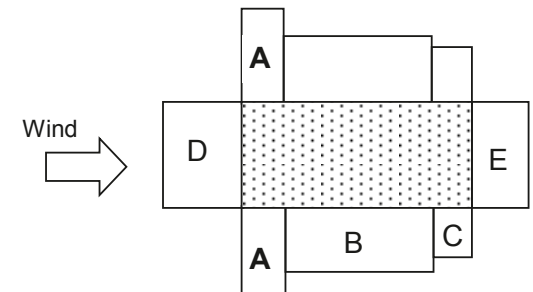

Design wind load (calculation value $F_d = F_{rep} * \gamma_F$) in kN/m² at building height ≤ 10 m

			Value of fundamental basic wind velocity $v_{b,map}$ (m/s)										
United Kingdom			28		26		25		23		22		
			Zone	A	B	A	B	A	B	A	B	A	B
Terrain category - Country	Distance upwind to shoreline (km)	≤ 0.1 to 1 km	-2.64	-1.76	-2.28	-1.52	-2.11	-1.41	-1.78	-1.19	-1.63	-1.09	
		1 to 10 km	-2.57	-1.71	-2.22	-1.48	-2.05	-1.37	-1.73	-1.16	-1.59	-1.06	
		10 to 100 km	-2.33	-1.55	-2.01	-1.34	-1.85	-1.24	-1.57	-1.05	-1.44	-0.96	
		≥ 100 km	-2.18	-1.46	-1.88	-1.26	-1.74	-1.16	-1.47	-0.98	-1.35	-0.90	
Terrain category - Town located 10-100 km upwind to shoreline	Distance building into town (km)	≤ 0.4 km	-2.33	-1.55	-2.01	-1.34	-1.85	-1.24	-1.57	-1.05	-1.44	-0.96	
		0.4-1 km	-2.31	-1.54	-1.99	-1.33	-1.84	-1.23	-1.56	-1.04	-1.43	-0.95	
		1-5 km	-2.14	-1.43	-1.84	-1.23	-1.71	-1.14	-1.44	-0.96	-1.32	-0.88	
		≥ 5 km	-1.92	-1.28	-1.66	-1.11	-1.53	-1.02	-1.30	-0.87	-1.19	-0.79	

Note: Building height ≤ 10 m / Site altitude ≤ 50 m

When determining the fixing distances the following variables should be taken into account:

- Wind load
 - Determine the fundamental local basic wind velocity (map)
 - Determine the maximum height of the building (max. 10 m)
 - Determine the site altitude (max 50 m)
 - Determine the distance from the coast
 - Determine the distance to the town border
 - No frontline buildings (coast)
- Building area: zone A (corner area) or zone B (area between corners). For details see the figure below
- Type of board, thickness and fastening system
- Static load absorption, for example 1-field- or 2-field span
- Legal local requirements

Calculation examples: fixing distances Durable

Coated Rockpanel Durable boards, 8 mm thickness
Determining the fixing distances (screw, nail, rivet):

- ETA-07/0141
- Cavity closers (on the corners of the building)
- Maximum deflection of the panels 0.75 %
- Thickness gasket max. 0.5 mm
- Quality timber battens: \geq C18, service class 2 according EN 1995-1-1
- Nail length 32 mm
- $a_{R1} \geq 15$ mm
- $a_{R2} \geq 50$ mm
- If the table shows no fixing distance (-) or building height > 10 m, please contact Rockpanel for the possibilities and specific advice.
- Not applicable for Rockpanel Natural.

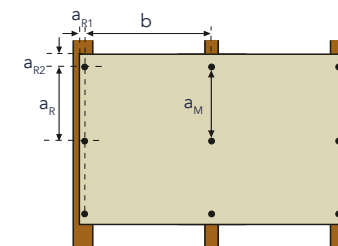

Edge distance a_{R1} (board thickness \leq 8 mm) : 15 mm
(board thickness \geq 9 mm) : 20 mm
Edge distance $a_{R2} \geq 50$ mm

Maximum fixing distance (mm) screws a_M for different c.t.c. distances (b) of the vertical sub-structure (k_{mod} : 0,90 / 1,00 / 1,10)

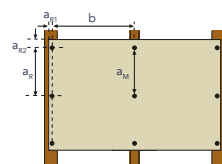

b (mm)	Design wind load on Rockpanel board ($F_d = F_{rep} * \gamma_F$) in kN/m ²												Durable 8 mm			
	-0.80	-0.90	-1.00	-1.10	-1.20	1.30	-1.40	-1.50	-1.60	-1.70	-1.80	-1.90	2.00	-2.10	2.20	-2.30
600	600	600	565	515	470	435	-	-	-	-	-	-	-	-	-	-
500	600	600	600	600	565	520	485	450	425	400	375	355	340	320	310	295
400	600	600	600	600	600	600	600	565	530	500	470	445	425	405	385	370
300	600	600	600	600	600	600	600	600	600	600	600	595	565	540	515	490

Maximum fixing distance (mm) nails a_M (length 32 mm) for different c.t.c. distances (b) of the vertical sub-structure (k_{mod} : 1.10)

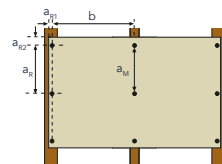

b (mm)	Design wind load on Rockpanel board ($F_d = F_{rep} * \gamma_F$) in kN/m ²												Durable 8 mm			
	-0.80	-0.90	-1.00	-1.10	-1.20	1.30	-1.40	-1.50	-1.60	-1.70	-1.80	-1.90	2.00	-2.10	2.20	-2.30
600	185	165	150	135	125	115	-	-	-	-	-	-	-	-	-	-
500	225	200	180	165	150	135	125	120	110	105	100	-	-	-	-	-
400	280	250	225	205	185	170	160	150	140	130	125	115	110	105	100	-
300	375	335	300	275	250	230	215	200	185	175	165	155	150	140	135	130

Maximum fixing distance (mm) rivets a_M for different c.t.c. distances (b) of the vertical sub-structure

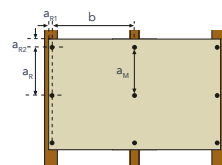

b (mm)	Design wind load on Rockpanel board ($F_d = F_{rep} * \gamma_F$) in kN/m ²												Durable 8 mm			
	-0.80	-0.90	-1.00	-1.10	-1.20	1.30	-1.40	-1.50	-1.60	-1.70	-1.80	-1.90	2.00	-2.10	2.20	-2.30
600	600	600	600	600	580	535	-	-	-	-	-	-	-	-	-	-
500	600	600	600	600	600	600	595	555	520	490	465	440	415	395	380	360
400	600	600	600	600	600	600	600	600	600	600	580	550	520	495	475	450
300	600	600	600	600	600	600	600	600	600	600	600	600	600	600	600	600

Coated Rockpanel Durable boards, 6 mm thickness
 Determining the fixing distances (screw, nail):

- ETA-08/0343
- Cavity closers (on the corners of the building)
- Maximum deflection of the panels 0.75 %
- Thickness gasket max. 0.5 mm
- Quality timber battens: \geq C18, service class 2 according EN 1995-1-1
- Nail length 32 mm
- $a_{R1} \geq 15$ mm
- $a_{R2} \geq 50$ mm
- If the table shows no fixing distance (-) or building height > 10 m, please contact Rockpanel for the possibilities and specific advice.

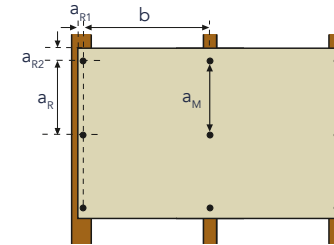

Edge distance a_{R1} (board thickness ≤ 8 mm) : 15 mm
 (board thickness ≥ 9 mm) : 20 mm
 Edge distance $a_{R2} \geq 50$ mm

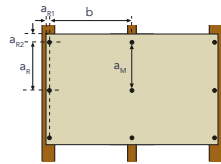

Maximum fixing distance (mm) screws a_M for different c.t.c. distances (b) of the vertical sub-construction (k_{mod} : 0,90 / 1,00 / 1,10)

b (mm)	Design wind load on Rockpanel board ($F_d = F_{rep} * \gamma_F$) in kN/m ²												Durable 6 mm			
	-0.80	-0.90	-1.00	-1.10	-1.20	1.30	-1.40	-1.50	-1.60	-1.70	-1.80	-1.90	2.00	-2.10	2.20	-2.30
400	300	300	300	300	300	300	300	300	300	300	-	-	-	-	-	-
300	300	300	300	300	300	300	300	300	300	300	300	3300	300	300	300	300

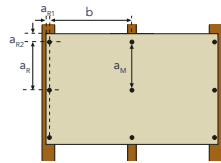

Maximum fixing distance (mm) nails a_M (length 32 mm) for different c.t.c. distances (b) of the vertical sub-construction (k_{mod} : 1.10)

b (mm)	Design wind load on Rockpanel board ($F_d = F_{rep} * \gamma_F$) in kN/m ²												Durable 6 mm			
	-0.80	-0.90	-1.00	-1.10	-1.20	1.30	-1.40	-1.50	-1.60	-1.70	-1.80	-1.90	2.00	-2.10	2.20	-2.30
400	300	300	290	265	240	225	205	195	180	170	-	-	-	-	-	-
300	300	300	300	300	300	300	275	260	240	225	215	205	195	185	175	165

Calculation examples: fixing distances Durable

Coated Rockpanel Durable boards, 8 mm thickness
Determining the fixing distances (screw, nail, rivet):

- ETA-07/0141
- Cavity closers (on the corners of the building)
- Maximum deflection of the panels 0.75 %
- Thickness gasket max. 0.5 mm
- Quality timber battens: \geq C18, service class 2 according EN 1995-1-1
- Nail length 32 mm
- $a_{R1} \geq 15$ mm
- $a_{R2} \geq 50$ mm
- If the table shows no fixing distance (-) or building height > 10 m, please contact Rockpanel for the possibilities and specific advice.
- Not applicable for Rockpanel Natural.

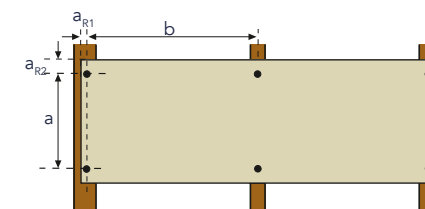

Edge distance a_{R1} (board thickness \leq 8 mm) : 15 mm
(board thickness \geq 9 mm) : 20 mm

Edge distance $a_{R2} \geq 50$ mm

Maximum fixing distance (mm) screws a for different c.t.c. distances (b) of the vertical sub-structure (k_{mod} : 0,90 / 1,00 / 1,10)

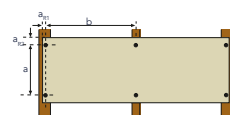

b (mm)	Design wind load on Rockpanel board ($F_d = F_{rep} * \gamma_F$) in kN/m ²												Durable 8 mm			
	-0.80	-0.90	-1.00	-1.10	-1.20	1.30	-1.40	-1.50	-1.60	-1.70	-1.80	-1.90	2.00	-2.10	2.20	-2.30
600	565	545	525	480	435	390	-	-	-	-	-	-	-	-	-	-
500	565	545	525	519	495	480	450	410	380	350	325	305	285	265	250	235
400	565	545	525	510	495	480	470	460	450	440	430	405	380	355	335	315
300	565	545	525	510	495	480	470	460	450	440	430	420	420	420	400	400

Maximum fixing distance (mm) nails a (length 32 mm) for different c.t.c. distances (b) of the vertical sub-structure (k_{mod} : 1,10)

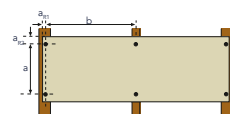

b (mm)	Design wind load on Rockpanel board ($F_d = F_{rep} * \gamma_F$) in kN/m ²												Durable 8 mm			
	-0.80	-0.90	-1.00	-1.10	-1.20	1.30	-1.40	-1.50	-1.60	-1.70	-1.80	-1.90	2.00	-2.10	2.20	-2.30
600	370	320	275	240	215	190	-	-	-	-	-	-	-	-	-	-
500	400	400	350	310	275	245	220	200	180	165	150	135	125	115	105	-
400	400	400	400	400	370	335	305	275	255	230	215	195	180	170	155	145
300	400	400	400	400	400	400	400	400	370	345	320	275	275	260	240	225

Maximum fixing distance (mm) rivets a for different c.t.c. distances (b) of the vertical sub-structure

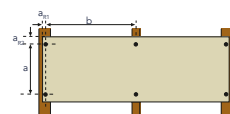

b (mm)	Design wind load on Rockpanel board ($F_d = F_{rep} * \gamma_F$) in kN/m ²												Durable 8 mm			
	-0.80	-0.90	-1.00	-1.10	-1.20	1.30	-1.40	-1.50	-1.60	-1.70	-1.80	-1.90	2.00	-2.10	2.20	-2.30
600	565	545	525	510	495	480	-	-	-	-	-	-	-	-	-	-
500	565	545	525	510	495	480	470	460	450	440	425	415	390	365	345	325
400	565	545	525	510	495	480	470	460	450	440	425	425	415	410	405	400
300	565	545	525	510	495	480	470	460	450	440	425	425	415	410	405	400

Coated Rockpanel Durable boards, 6 mm thickness
 Determining the fixing distances (screw, nail):

- ETA-08/0343
- Cavity closers (on the corners of the building)
- Maximum deflection of the panels 0.75 %
- Thickness gasket max. 0.5 mm
- Quality timber battens: \geq C18, service class 2 according EN 1995-1-1
- Nail length 32 mm
- $a_{R1} \geq 15$ mm
- $a_{R2} \geq 50$ mm
- If the table shows no fixing distance (-) or building height > 10 m, please contact Rockpanel for the possibilities and specific advice.

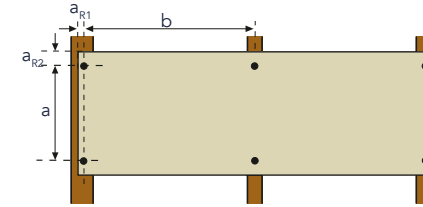

Edge distance a_{R1} (board thickness ≤ 8 mm) : 15 mm
 (board thickness ≥ 9 mm) : 20 mm
 Edge distance $a_{R2} \geq 50$ mm

Maximum fixing distance (mm) screws a for different c.t.c. distances (b) of the vertical sub-construction (k_{mod} : 0,90 / 1,00 / 1,10)

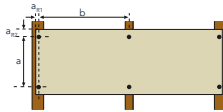

b (mm)	Design wind load on Rockpanel board ($F_d = F_{rep} * \gamma_F$) in kN/m ²												Durable 6 mm				
	-0.80	-0.90	-1.00	-1.10	-1.20	1.30	-1.40	-1.50	-1.60	-1.70	-1.80	-1.90	2.00	-2.10	2.20	-2.30	
400	300	300	300	300	300	300	300	300	300	300	-	-	-	-	-	-	
300	300	300	300	300	300	300	300	300	300	300	300	300	3300	300	300	300	300

Maximum fixing distance (mm) nails a (length 32 mm) for different c.t.c. distances (b) of the vertical sub-construction (k_{mod} : 1.10)

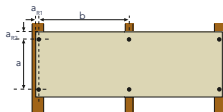

b (mm)	Design wind load on Rockpanel board ($F_d = F_{rep} * \gamma_F$) in kN/m ²												Durable 6 mm			
	-0.80	-0.90	-1.00	-1.10	-1.20	1.30	-1.40	-1.50	-1.60	-1.70	-1.80	-1.90	2.00	-2.10	2.20	-2.30
400	300	300	300	300	300	300	300	300	290	265	-	-	-	-	-	-
300	300	300	300	300	300	300	300	300	300	300	300	300	300	295	280	260

Calculation examples: fixing distances Durable

Coated Rockpanel Durable boards, 8 mm thickness
Determining the fixing distances (screw, nail, rivet):

- ETA-07/0141
- Cavity closers (on the corners of the building)
- Maximum deflection of the panels 0.75 %
- Thickness gasket max. 0.5 mm
- Quality timber battens: \geq C18, service class 2 according EN 1995-1-1
- Nail length 32 mm
- $a_{R1} \geq 15$ mm
- $a_{R2} \geq 50$ mm
- If the table shows no fixing distance (-) or building height > 10 m, please contact Rockpanel for the possibilities and specific advice.
- Not applicable for Rockpanel Natural.

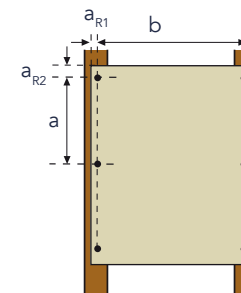

Edge distance a_{R1} (board thickness \leq 8 mm) : 15 mm
(board thickness \geq 9 mm) : 20 mm
Edge distance $a_{R2} \geq 50$ mm

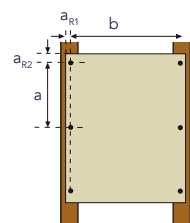

Maximum fixing distance (mm) screws a for different c.t.c. distances (b) of the vertical sub-construction (k_{mod} : 0,90 / 1,00 / 1,10)

b (mm)	Design wind load on Rockpanel board ($F_d = F_{rep} * \gamma_F$) in kN/m ²												Durable 8 mm			
	-0.80	-0.90	-1.00	-1.10	-1.20	1.30	-1.40	-1.50	-1.60	-1.70	-1.80	-1.90	2.00	-2.10	2.20	-2.30
600	-	-	-	-	-	-	-	-	-	-	-	-	-	-	-	-
500	600	600	600	600	-	-	-	-	-	-	-	-	-	-	-	-
400	600	600	600	600	600	600	580	570	560	540	540	530	480	455	435	415
300	600	600	600	600	600	600	580	570	560	540	540	530	520	510	500	490

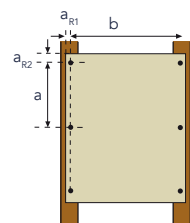

Maximum fixing distance (mm) nails a (length 32 mm) for different c.t.c. distances (b) of the vertical sub-construction (k_{mod} : 1.10)

b (mm)	Design wind load on Rockpanel board ($F_d = F_{rep} * \gamma_F$) in kN/m ²												Durable 8 mm			
	-0.80	-0.90	-1.00	-1.10	-1.20	1.30	-1.40	-1.50	-1.60	-1.70	-1.80	-1.90	2.00	-2.10	2.20	-2.30
600	-	-	-	-	-	-	-	-	-	-	-	-	-	-	-	-
500	400	400	400	400	-	-	-	-	-	-	-	-	-	-	-	-
400	400	400	400	400	400	400	400	375	355	330	315	295	280	270	255	245
300	400	400	400	400	400	400	400	400	400	400	400	390	365	355	340	325

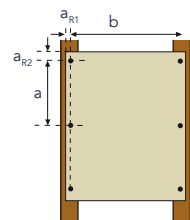

Maximum fixing distance (mm) rivets a for different c.t.c. distances (b) of the vertical sub-construction

b (mm)	Design wind load on Rockpanel board ($F_d = F_{rep} * \gamma_F$) in kN/m ²												Durable 8 mm			
	-0.80	-0.90	-1.00	-1.10	-1.20	1.30	-1.40	-1.50	-1.60	-1.70	-1.80	-1.90	2.00	-2.10	2.20	-2.30
600	-	-	-	-	-	-	-	-	-	-	-	-	-	-	-	-
500	600	600	600	600	-	-	-	-	-	-	-	-	-	-	-	-
400	600	600	600	600	600	600	580	570	560	540	540	530	520	510	500	490
300	600	600	600	600	600	600	580	580	560	540	540	530	520	510	500	490

Coated Rockpanel Durable boards, 6 mm thickness
 Determining the fixing distances (screw, nail):

- ETA-08/0343
- Cavity closers (on the corners of the building)
- Maximum deflection of the panels 0.75 %
- Thickness gasket max. 0.5 mm
- Quality timber battens: \geq C18, service class 2 according EN 1995-1-1
- Nail length 32 mm
- $a_{R1} \geq 15$ mm
- $a_{R2} \geq 50$ mm
- If the table shows no fixing distance (-) or building height $>$ 10 m, please contact Rockpanel for the possibilities and specific advice.

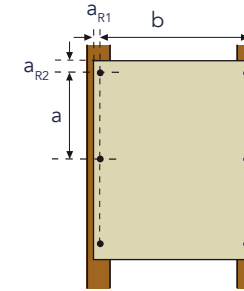

Edge distance a_{R1} (board thickness \leq 8 mm) : 15 mm
 (board thickness \geq 9 mm) : 20 mm
 Edge distance $a_{R2} \geq 50$ mm

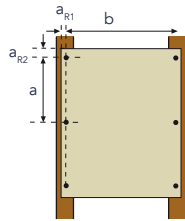

Maximum fixing distance (mm) screws a for different c.t.c. distances (b) of the vertical sub-construction (k_{mod} : 0,90 / 1,00 / 1,10)

b (mm)	Design wind load on Rockpanel board ($F_d = F_{rep} * \gamma_F$) in kN/m ²												Durable 6 mm			
	-0.80	-0.90	-1.00	-1.10	-1.20	1.30	-1.40	-1.50	-1.60	-1.70	-1.80	-1.90	2.00	-2.10	2.20	-2.30
400	300	300	-	-	-	-	-	-	-	-	-	-	-	-	-	-
300	300	300	300	300	300	300	300	300	300	300	300	3300	300	300	300	300

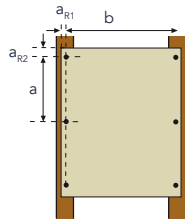

Maximum fixing distance (mm) nails a (length 32 mm) for different c.t.c. distances (b) of the vertical sub-construction (k_{mod} : 1.10)

b (mm)	Design wind load on Rockpanel board ($F_d = F_{rep} * \gamma_F$) in kN/m ²												Durable 6 mm			
	-0.80	-0.90	-1.00	-1.10	-1.20	1.30	-1.40	-1.50	-1.60	-1.70	-1.80	-1.90	2.00	-2.10	2.20	-2.30
400	300	300	-	-	-	-	-	-	-	-	-	-	-	-	-	-
300	300	300	300	300	300	300	300	300	300	300	300	300	300	300	300	300

Calculation examples: fixing distances Durable

Coated Rockpanel Durable boards, 8 mm thickness
Determining the fixing distances (screw, nail, rivet):

- ETA-07/0141
- Cavity closers (on the corners of the building)
- Maximum deflection of the panels 0.75 %
- Thickness gasket max. 0.5 mm
- Quality timber battens: \geq C18, service class 2 according EN 1995-1-1
- Nail length 32 mm
- $a_{R1} \geq 15$ mm
- $a_{R2} \geq 50$ mm
- If the table shows no fixing distance (-) or building height > 10 m, please contact Rockpanel for the possibilities and specific advice.
- Not applicable for Rockpanel Natural.

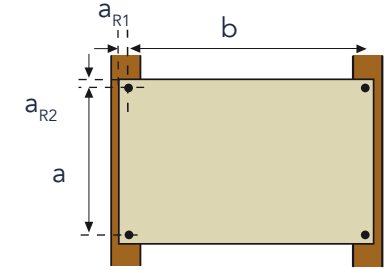

Edge distance a_{R1} (board thickness \leq 8 mm) : 15 mm
(board thickness \geq 9 mm) : 20 mm
Edge distance $a_{R2} \geq 50$ mm

Maximum fixing distance (mm) screws a for different c.t.c. distances (b) of the vertical sub-construction (k_{mod} : 0,90 / 1,00 / 1,10)

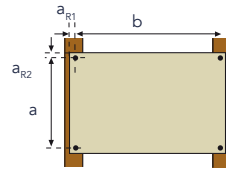

b (mm)	Design wind load on Rockpanel board ($F_d = F_{rep} * \gamma_F$) in kN/m ²												Durable 8 mm			
	-0.80	-0.90	-1.00	-1.10	-1.20	1.30	-1.40	-1.50	-1.60	-1.70	-1.80	-1.90	2.00	-2.10	2.20	-2.30
600	-	-	-	-	-	-	-	-	-	-	-	-	-	-	-	-
500	570	545	525	510	-	-	-	-	-	-	-	-	-	-	-	-
400	570	545	525	510	495	480	470	460	450	440	430	420	420	410	400	400
300	570	545	525	510	495	480	470	460	450	440	430	420	420	410	400	400

Maximum fixing distance (mm) nails a (length 32 mm) for different c.t.c. distances (b) of the vertical sub-construction (k_{mod} : 1.10)

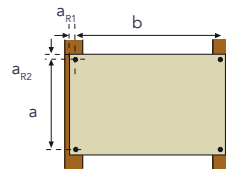

b (mm)	Design wind load on Rockpanel board ($F_d = F_{rep} * \gamma_F$) in kN/m ²												Durable 8 mm			
	-0.80	-0.90	-1.00	-1.10	-1.20	1.30	-1.40	-1.50	-1.60	-1.70	-1.80	-1.90	2.00	-2.10	2.20	-2.30
600	-	-	-	-	-	-	-	-	-	-	-	-	-	-	-	-
500	400	400	400	400	-	-	-	-	-	-	-	-	-	-	-	-
400	400	400	400	400	400	400	400	400	400	400	400	400	400	400	400	400
300	400	400	400	400	400	400	400	400	400	400	400	400	400	400	400	400

Maximum fixing distance (mm) rivets a for different c.t.c. distances (b) of the vertical sub-construction

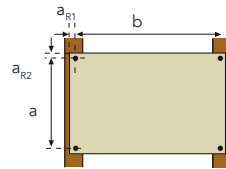

b (mm)	Design wind load on Rockpanel board ($F_d = F_{rep} * \gamma_F$) in kN/m ²												Durable 8 mm			
	-0.80	-0.90	-1.00	-1.10	-1.20	1.30	-1.40	-1.50	-1.60	-1.70	-1.80	-1.90	2.00	-2.10	2.20	-2.30
600	-	-	-	-	-	-	-	-	-	-	-	-	-	-	-	-
500	570	545	525	510	-	-	-	-	-	-	-	-	-	-	-	-
400	570	545	525	510	495	480	470	460	450	440	435	425	420	410	400	400
300	570	545	525	510	495	480	470	460	450	440	435	425	420	410	400	400

Coated Rockpanel Durable boards, 6 mm thickness
 Determining the fixing distances (screw, nail):

- ETA-08/0343
- Cavity closers (on the corners of the building)
- Maximum deflection of the panels 0.75 %
- Thickness gasket max. 0.5 mm
- Quality timber battens: \geq C18, service class 2 according EN 1995-1-1
- Nail length 32 mm
- $a_{R1} \geq 15$ mm
- $a_{R2} \geq 50$ mm
- If the table shows no fixing distance (-) or building height > 10 m, please contact Rockpanel for the possibilities and specific advice.

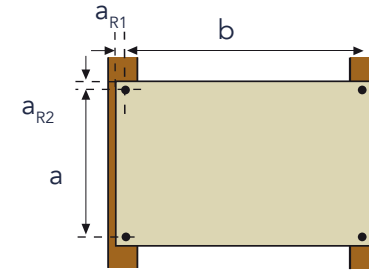

Edge distance a_{R1} (board thickness ≤ 8 mm) : 15 mm
 (board thickness ≥ 9 mm) : 20 mm
 Edge distance $a_{R2} \geq 50$ mm

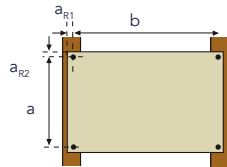

Maximum fixing distance (mm) screws a for different c.t.c. distances (b) of the vertical sub-construction (k_{mod} : 0,90 / 1,00 / 1,10)

b (mm)	Design wind load on Rockpanel board ($F_d = F_{rep} * \gamma_F$) in kN/m ²												Durable 6 mm				
	-0.80	-0.90	-1.00	-1.10	-1.20	1.30	-1.40	-1.50	-1.60	-1.70	-1.80	-1.90	2.00	-2.10	2.20	-2.30	
400	300	300	-	-	-	-	-	-	-	-	-	-	-	-	-	-	
300	300	300	300	300	300	300	300	300	300	300	300	300	3300	300	300	300	300

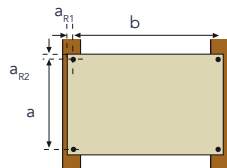

Maximum fixing distance (mm) nails a (length 32 mm) for different c.t.c. distances (b) of the vertical sub-construction (k_{mod} : 1,10)

b (mm)	Design wind load on Rockpanel board ($F_d = F_{rep} * \gamma_F$) in kN/m ²												Durable 6 mm				
	-0.80	-0.90	-1.00	-1.10	-1.20	1.30	-1.40	-1.50	-1.60	-1.70	-1.80	-1.90	2.00	-2.10	2.20	-2.30	
400	300	300	-	-	-	-	-	-	-	-	-	-	-	-	-	-	
300	300	300	300	300	300	300	300	300	300	300	300	300	300	300	300	300	300

Calculation examples: fixing distances Uni

Coated Rockpanel Uni boards, 6 mm thickness
Determining the fixing distances (screw, nail):

- ETA-17/0619
- Cavity closers (on the corners of the building)
- Maximum deflection of the panels 0.75 %
- Thickness gasket max. 0.5 mm
- Quality timber battens: \geq C18, service class 2 according EN 1995-1-1
- Nail length 32 mm
- $a_{R1} \geq 15$ mm
- $a_{R2} \geq 50$ mm
- If the table shows no fixing distance (-) or building height > 10 m, please contact Rockpanel for the possibilities and specific advice.

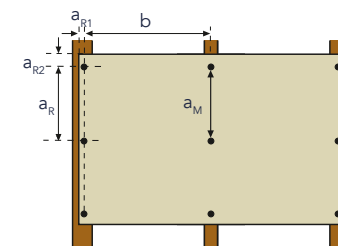

Edge distance a_{R1} (board thickness \leq 8 mm) : 15 mm
(board thickness \geq 9 mm) : 20 mm
Edge distance $a_{R2} \geq 50$ mm

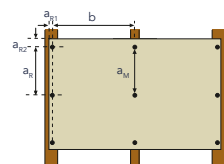

Maximum fixing distance (mm) screws a_M for different c.t.c. distances (b) of the vertical sub-construction (k_{mod} : 0,90 / 1,00 / 1,10)

b (mm)	Design wind load on Rockpanel board ($F_d = F_{rep} * \gamma_F$) in kN/m ²												Uni 6 mm			
	-0.80	-0.90	-1.00	-1.10	-1.20	1.30	-1.40	-1.50	-1.60	-1.70	-1.80	-1.90	2.00	-2.10	2.20	-2.30
400	300	300	300	300	300	300	300	300	295	-	-	-	-	-	-	-
300	300	300	300	300	300	300	300	300	295	300	260	245	235	225	215	205

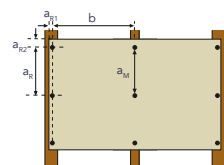

Maximum fixing distance (mm) nails a_M (length 32 mm) for different c.t.c. distances (b) of the vertical sub-construction (k_{mod} : 1,10)

b (mm)	Design wind load on Rockpanel board ($F_d = F_{rep} * \gamma_F$) in kN/m ²												Uni 6 mm			
	-0.80	-0.90	-1.00	-1.10	-1.20	1.30	-1.40	-1.50	-1.60	-1.70	-1.80	-1.90	2.00	-2.10	2.20	-2.30
400	300	300	290	265	240	225	205	195	180	-	-	-	-	-	-	-
300	300	300	290	265	240	225	205	195	180	170	160	150	145	135	130	125

Coated Rockpanel Uni boards, 6 mm thickness
 Determining the fixing distances (screw, nail):

- ETA-17/0619
- Cavity closers (on the corners of the building)
- Maximum deflection of the panels 0.75 %
- Thickness gasket max. 0.5 mm
- Quality timber battens: \geq C18, service class 2 according EN 1995-1-1
- Nail length 32 mm
- $a_{R1} \geq 15$ mm
- $a_{R2} \geq 50$ mm
- If the table shows no fixing distance (-) or building height > 10 m, please contact Rockpanel for the possibilities and specific advice.

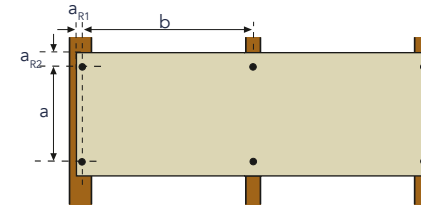

Edge distance a_{R1} (board thickness \leq 8 mm) : 15 mm
 (board thickness \geq 9 mm) : 20 mm
 Edge distance $a_{R2} \geq 50$ mm

Maximum fixing distance (mm) screws a for different c.t.c. distances (b) of the vertical sub-construction (k_{mod} : 0,90 / 1,00 / 1,10)

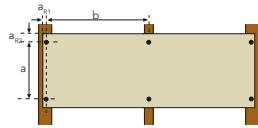

b (mm)	Design wind load on Rockpanel board ($F_d = F_{rep} * \gamma_F$) in kN/m ²												Uni 6 mm			
	-0.80	-0.90	-1.00	-1.10	-1.20	1.30	-1.40	-1.50	-1.60	-1.70	-1.80	-1.90	2.00	-2.10	2.20	-2.30
400	300	300	300	300	300	300	300	300	300	-	-	-	-	-	-	-
300	300	300	300	300	300	300	300	300	300	275	255	235	220	205	-	-

Maximum fixing distance (mm) nails a (length 32 mm) for different c.t.c. distances (b) of the vertical sub-construction (k_{mod} : 1.10)

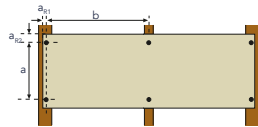

b (mm)	Design wind load on Rockpanel board ($F_d = F_{rep} * \gamma_F$) in kN/m ²												Uni 6 mm			
	-0.80	-0.90	-1.00	-1.10	-1.20	1.30	-1.40	-1.50	-1.60	-1.70	-1.80	-1.90	2.00	-2.10	2.20	-2.30
400	300	300	300	300	300	300	295	270	245	-	-	-	-	-	-	-
300	300	300	300	300	300	300	295	270	245	225	210	190	175	165	-	-

Calculation examples: fixing distances Uni

Coated Rockpanel Uni boards, 6 mm thickness
Determining the fixing distances (screw, nail):

- ETA-17/0619
- Cavity closers (on the corners of the building)
- Maximum deflection of the panels 0.75 %
- Thickness gasket max. 0.5 mm
- Quality timber battens: \geq C18, service class 2 according EN 1995-1-1
- Nail length 32 mm
- $a_{R1} \geq 15$ mm
- $a_{R2} \geq 50$ mm
- If the table shows no fixing distance (-) or building height > 10 m, please contact Rockpanel for the possibilities and specific advice.

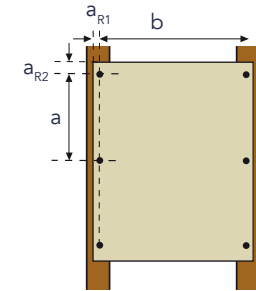

Edge distance a_{R1} (board thickness \leq 8 mm) : 15 mm
(board thickness \geq 9 mm) : 20 mm
Edge distance $a_{R2} \geq 50$ mm

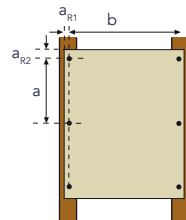

Maximum fixing distance (mm) screws a for different c.t.c. distances (b) of the vertical sub-construction (k_{mod} : 0,90 / 1,00 / 1,10)

b (mm)	Design wind load on Rockpanel board ($F_d = F_{rep} * \gamma_F$) in kN/m ²												Uni 6 mm			
	-0.80	-0.90	-1.00	-1.10	-1.20	1.30	-1.40	-1.50	-1.60	-1.70	-1.80	-1.90	2.00	-2.10	2.20	-2.30
400	300	-	-	-	-	-	-	-	-	-	-	-	-	-	-	-
300	300	300	300	300	300	300	300	300	300	300	300	300	300	300	300	300

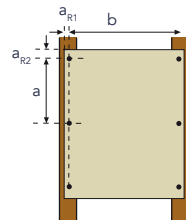

Maximum fixing distance (mm) nails a (length 32 mm) for different c.t.c. distances (b) of the vertical sub-construction (k_{mod} : 1.10)

b (mm)	Design wind load on Rockpanel board ($F_d = F_{rep} * \gamma_F$) in kN/m ²												Uni 6 mm			
	-0.80	-0.90	-1.00	-1.10	-1.20	1.30	-1.40	-1.50	-1.60	-1.70	-1.80	-1.90	2.00	-2.10	2.20	-2.30
400	300	-	-	-	-	-	-	-	-	-	-	-	-	-	-	-
300	300	300	300	300	300	300	300	300	300	300	300	300	300	300	300	300

Coated Rockpanel Uni boards, 6 mm thickness
 Determining the fixing distances (screw, nail):

- ETA-17/0619
- Cavity closers (on the corners of the building)
- Maximum deflection of the panels 0.75 %
- Thickness gasket max. 0.5 mm
- Quality timber battens: \geq C18, service class 2 according EN 1995-1-1
- Nail length 32 mm
- $a_{R1} \geq 15$ mm
- $a_{R2} \geq 50$ mm
- If the table shows no fixing distance (-) or building height > 10 m, please contact Rockpanel for the possibilities and specific advice.

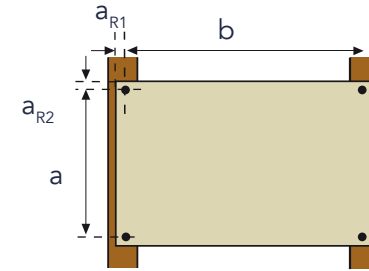

Edge distance a_{R1} (board thickness ≤ 8 mm) : 15 mm
 (board thickness ≥ 9 mm) : 20 mm
 Edge distance $a_{R2} \geq 50$ mm

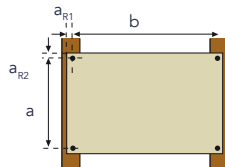

Maximum fixing distance (mm) screws a for different c.t.c. distances (b) of the vertical sub-construction (k_{mod} : 0,90 / 1,00 / 1,10)

b (mm)	Design wind load on Rockpanel board ($F_d = F_{rep} * \gamma_F$) in kN/m ²												Uni 6 mm			
	-0.80	-0.90	-1.00	-1.10	-1.20	1.30	-1.40	-1.50	-1.60	-1.70	-1.80	-1.90	2.00	-2.10	2.20	-2.30
400	300	-	-	-	-	-	-	-	-	-	-	-	-	-	-	-
300	300	300	300	300	300	300	300	300	300	300	300	300	300	295	290	285

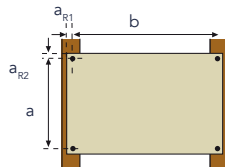

Maximum fixing distance (mm) nails a (length 32 mm) for different c.t.c. distances (b) of the vertical sub-construction (k_{mod} : 1,10)

b (mm)	Design wind load on Rockpanel board ($F_d = F_{rep} * \gamma_F$) in kN/m ²												Uni 6 mm			
	-0.80	-0.90	-1.00	-1.10	-1.20	1.30	-1.40	-1.50	-1.60	-1.70	-1.80	-1.90	2.00	-2.10	2.20	-2.30
400	300	-	-	-	-	-	-	-	-	-	-	-	-	-	-	-
300	300	300	300	300	300	300	300	300	300	300	300	300	300	295	290	285

Calculation examples: fixing distances Lines²

Tongue and groove cladding boards

Maximum fixing distances for Rockpanel Lines² on a timber sub-construction
Rockpanel Lines² 10 mm

- Location in country
- Distance from coast > 10 km
- Site altitude ≤ 50 m
- Strength class timber sub-construction C24 according EN338
- Aluminium sub-construction according ETA
- $a_{R1} \geq 15$ mm, $a_{R2} = 15$, $a_{R3} \geq 20$ mm

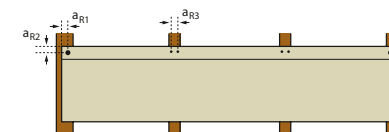

Maximum permissible building height (m) Lines² 10 mm with a 2-field span, fixed using a double Rockpanel ring shank nail, 2,1/2,3 x 27 mm at the intermediate battens.

Basic wind velocity	Span c.t.c. (mm)	Lines ² 10 XL		Lines ² 10 S	
		Zone B: Middle area	Zone A: Corner area	Zone B: Middle area	Zone A: Corner area
22 m/s	600	30	10	30*	30*
	500	30*	20	30*	30*
23 m/s	600	20	7	30*	30
	500	30*	15	30*	30*
24 m/s	600	15	7	30*	20
	500	30	15	30*	30*
25 m/s	600	10	5	30*	15
	500	20	10	30*	30*
26 m/s	600	7	-	30	10
	500	15	7	30*	30*

- If the table shows no fixing distance (-), contact Rockpanel for the possibilities and specific advice.
 - For applications < 10 km from the coast, also at higher site altitudes and higher wind speeds, Rockpanel should be consulted.
 - The specification of the Rockpanel screw and rivet should be in accordance with the appropriate ETA.
- * Higher buildings not calculated. Contact Rockpanel for advice

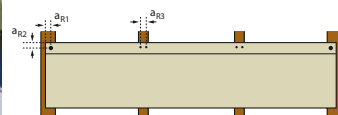

Tongue and groove cladding boards

Maximum fixing distances for Rockpanel Lines² on a timber sub-construction
 Rockpanel Lines² 10 mm

- Location in country
- Distance from coast > 10 km
- Site altitude ≤ 50 m
- Strength class timber sub-construction C24 according EN338
- Aluminium sub-construction according ETA
- $a_{R1} \geq 15$ mm, $a_{R2} = 15$, $a_{R3} \geq 20$ mm

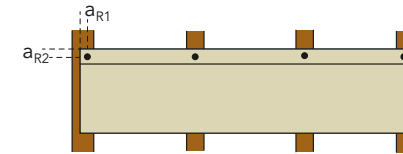

Maximum permissible building height (m) Lines² 10 mm with a 2-field span, fixed using a single Rockpanel ring shank nail, 2,1/2,3 x 27 mm at the intermediate battens.

Basic wind velocity	Span c.t.c. (mm)	Lines ² 10 XL		Lines ² 10 S	
		Zone B: Middle area	Zone A: Corner area	Zone B: Middle area	Zone A: Corner area
22 m/s	600	-	-	30	10
	500	5	-	30*	20
23 m/s	600	-	-	20	7
	500	-	-	30*	15
24 m/s	600	-	-	15	5
	500	-	-	30	10
25 m/s	600	-	-	10	-
	500	-	-	20	7
26 m/s	600	-	-	7	-
	500	-	-	15	5

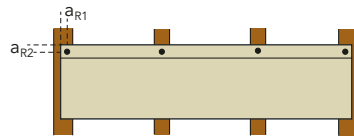

- If the table shows no fixing distance (-), contact Rockpanel for the possibilities and specific advice.
 - For applications < 10 km from the coast, also at higher site altitudes and higher wind speeds, Rockpanel should be consulted.
 - The specification of the Rockpanel screw and rivet should be in accordance with the appropriate ETA.
- * Higher buildings not calculated. Contact Rockpanel for advice

Board joints, corner solutions and bending

Board joints

- Rockpanel is dimensionally stable, and therefore resistant to changes in length and width arising from variations in temperature and humidity.
- Take into account that boards, installation and building tolerances play an important role in the detailing of joints.
- Apply weather- and UV-resistant EPDM gasket behind the joints to protect the sub-construction against weather influences.
- The joints should be equal to or bigger than 5 mm, to ensure proper drainage.
- See paragraph 'ventilated constructions' on page 104-106 for horizontal and vertical board connections and the 'fixing guidelines' subsection on pages 118-120 for the opportunities for wind reduction with open joints.
- In horizontal use of Rockpanel Lines², horizontal seams are automatically covered by the overlaid board and no additional finishing of the seam is necessary, on vertical framework, weather resistant joint tape should be applied to protect the framework. Rockpanel recommends that a joint width of at least 3 mm should be maintained between the boards.

Corner solutions

Finishing the edges is only necessary to meet any design or aesthetic requirements. Rockpanel offers a range of solutions for an attractive finish at corners and edges.

Assembly corner joint with natural dark brown edges

Without finishing, the basic material changes colour to natural dark brown under the effect of UV.

Corner profiles in a RAL/NCS colour

A solution with a corner profile in a compatible RAL colour ensures a perfect finish.

See page 66 for a complete overview of the profiles.

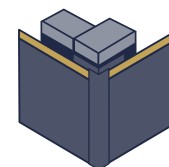
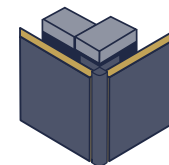

Mitre joint

For the highly skilled installer, a mitre joint can be achieved with the material, thereby creating a precise and uniform finish.

Important: the minimum panel thickness for this solution is 8 mm.

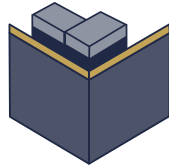

Edge paint

Finishing the edges with matching colour paint is another option.

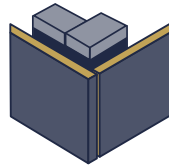

Bending and curving

Rockpanel boards can easily be bent and curved without any treatment. This allows even more design possibilities for creating beautiful facade finishes. The advised minimum bending radius is determined by the bending strength of the Rockpanel boards, assuming that the board is bent lengthwise. The following values only apply for Durable and A2.

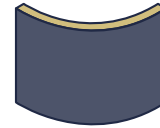

Rockpanel Colours, Metals, Woods, Stones & Chameleon

Panel thickness (mm)	Durable 6	Durable 8	A2 9
Panel length (curve, mm)	3050	3050	3050
Radius R minimal (mm)	1900	2500	3600
Corner α	91.97°	69.9°	48.54°
Chord (mm)	2733	2864	2959
Level (mm)	580	451	318
Battens c.t.c. (mm)	300	400	**
Fixings c.t.c. (mm)*	250	300	**

* Indication for the fixing distances in urban and rural environments with building heights ≤ 10 m. When Rockpanel is applied in bent or curved conditions on higher buildings or in environments with a higher wind load, please contact Rockpanel.

** For fixing distances of bended A2 boards, please contact Rockpanel.

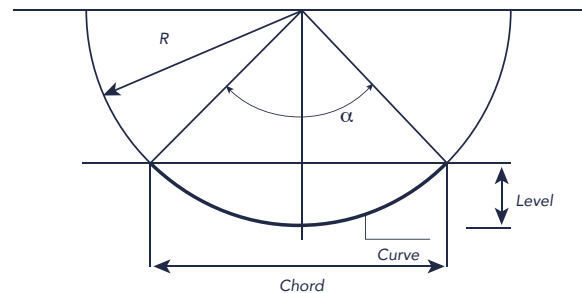

Guidelines seamless installation

Rockpanel board material retains its shape as it is able to withstand moisture and changes in temperature. This allows it to be used seamlessly under certain conditions:

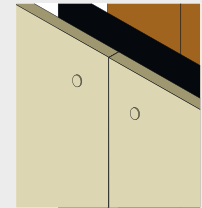

- Only for use around the roofline, such as to finish guttering, for fascias and barge boards. If you are considering another application with butt joints, contact Rockpanel for individual and expert advice;
- Up to a maximum length of 12 metres;
- Only when a timber subframe is used with vertical battens to prevent the subframe from warping;
- The timber subframe is protected by using EPDM foam gaskets for all joints on the subframe;
- Expansion joints are used throughout the Rockpanel construction. If there are expansion joints in the structure, the facade panels must also have expansion joints.
- Only applicable with light colours.

If you wish to specify an application with butt joints contact Rockpanel for an advice.

Details

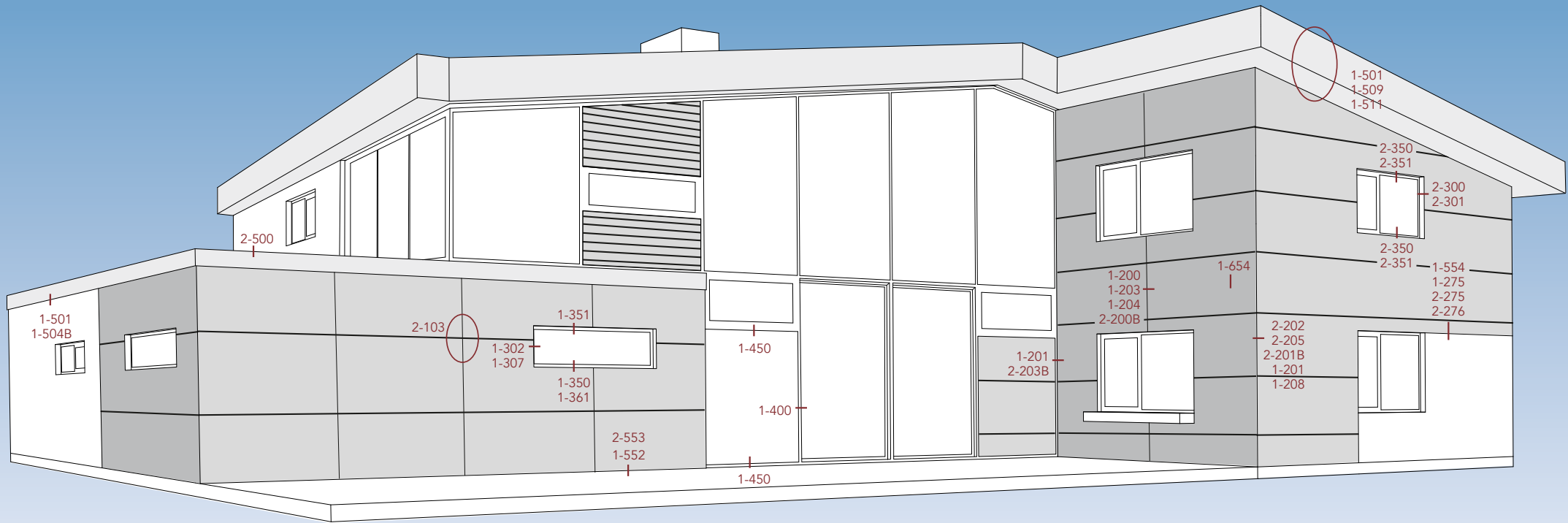

Facade

Aluminium sub-construction 48 - 54

- 2-103: mechanically fixed, principles
- 2-200B: mechanically fixed to aluminium supports, abutment vertical joint
- 2-201B: mechanically fixed to aluminium supports, external corner
- 2-203B: mechanically fixed to aluminium supports, internal corner
- 2-205: concealed fixing, external corner
- 2-300: mechanically fixed, horizontal junction to a window frame
- 2-301: mechanically fixed, horizontal junction to a window frame, finished with a metal sheet
- 2-350: mechanically fixed, vertical junction over window frame
- 2-351: vertical section over window frame with aluminium substructure with metal reveal
- 2-500: mechanically fixed, vertical cross section at flat roof
- 2-553: concealed fixing, abutting detail pavement
- 2-275: mechanical fixing – ETICS
- 2-276: mechanical fixed, junction to ETICS

Timber sub-construction 55 - 61

- 1-200: mechanically fixed to timber support, with vertical joints
- 1-201: mechanically fixed to timber support, internal and external corner
- 1-203: mechanically fixed to timber supports, vertical joints, vertical intermediate fastening using a Rockpanel strip
- 1-204: adhesive installation on timber sub-construction with Rockpanel strips
- 1-208: mechanically fixed to timber supports, with vertical external aluminium corner profile
- 1-275: mechanically fixed, junction to ETICS
- 1-302: mechanically fixed to timber supports, horizontal window-frame junction with profile
- 1-307: mechanically fixed, on timber sub-construction, horizontal cross section at window frame junction

- 1-350: mechanically fixed to timber supports, vertical junction at window-sill
- 1-351: mechanically fixed to timber supports, junction at window head
- 1-361: mechanically fixed, on timber sub-construction, vertical cross section junction at window-sill
- 1-552: mechanically fixed, connection at ground level
- 1-554: mechanically fixed, junction to a plaster wall

Sustainable construction

BRE-certified construction 62

- 1-654: Vertical cross section of a ventilated facade on a timber sub-construction

Roofline

New build63

- 1-501: mechanically fixed, fascia board new build
- 1-509: mechanically fixed, soffit board new build

Renovation64

- 1-504B: mechanically fixed, fascia board renovation
- 1-511: mechanically fixed, soffit board renovation

Detailing

Non-ventilated applications 65

- 1-400: mechanically fixed, non-ventilated infilling (horizontal)
- 1-450: mechanically fixed, non-ventilated infilling (vertical)

These CAD details provide basic guidelines and should be checked on relevance and accuracy when considered for actual installation.

Facade

Aluminium
sub-construction

Mechanically fixed: principles

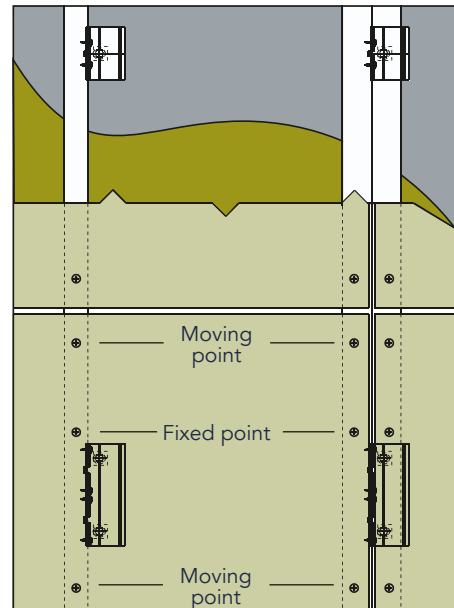

Detail 2-103

Note:

Rockpanel cannot be used unventilated with aluminium support structures.

Attention:

For aluminium constructions in an open facade Rockpanel recommends a cavity depth of 40 mm - 100 mm.

Mechanically fixed to aluminium supports, abutment vertical joint

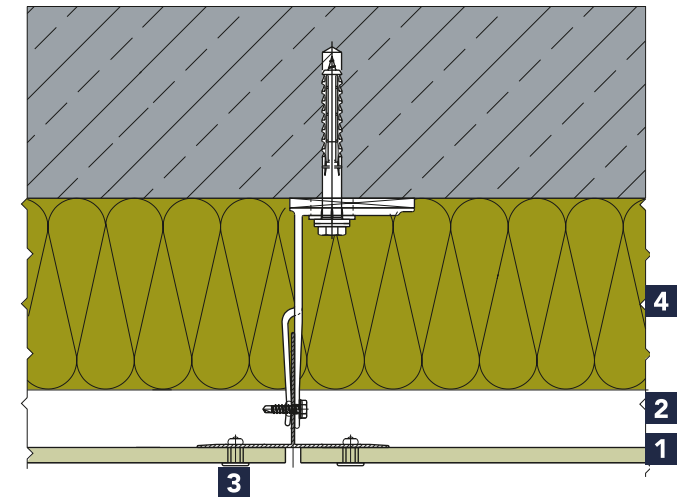

Detail 2-200B

- 1** Rockpanel ≥ 8 mm
- 2** Ventilation
- 3** Rivet according to specifications
- 4** Insulation (for example ROCKWOOL)

Mechanically fixed to aluminium supports, external corner

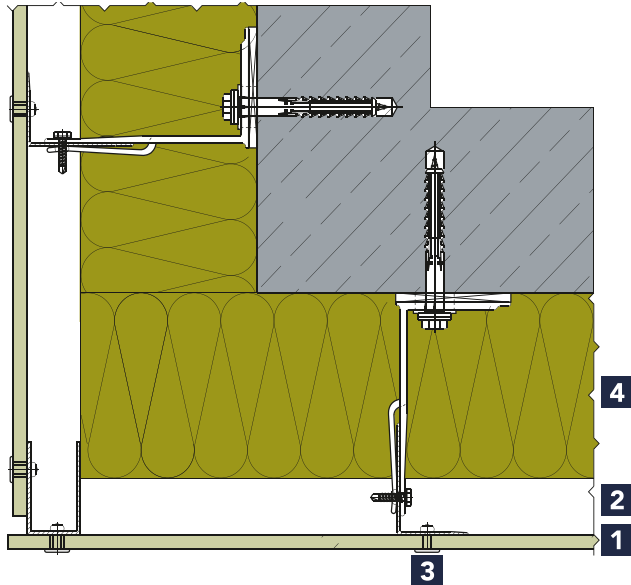

Detail 2-201B

- 1** Rockpanel ≥ 8 mm
- 2** Ventilation
- 3** Rivet according to specifications
- 4** Insulation (for example ROCKWOOL)

Mechanically fixed to aluminium supports, internal corner

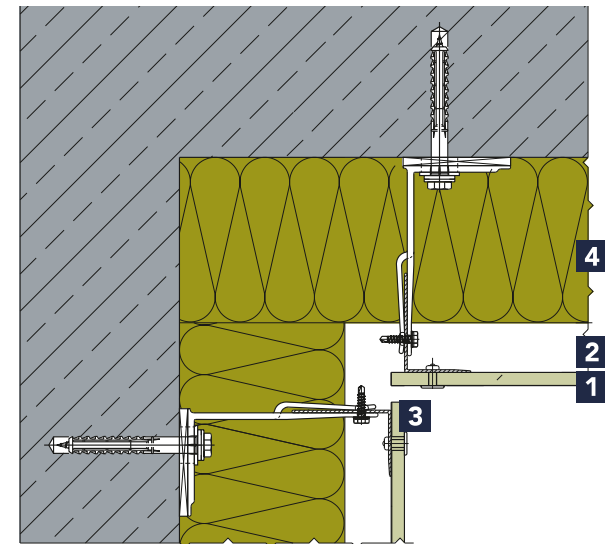

Detail 2-203B

- 1** Rockpanel ≥ 8 mm
- 2** Ventilation
- 3** Rivet according to specifications
- 4** Insulation (for example ROCKWOOL)

Facade

Aluminium
sub-construction

Concealed fixing, external corner

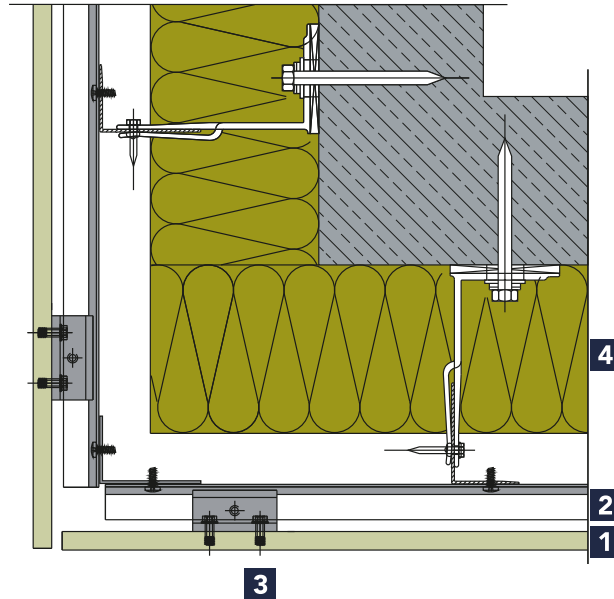

Detail 2-205

- 1** Rockpanel 11 mm
- 2** Ventilation
- 3** Concealed fixing clip according to specifications
- 4** Insulation (for example ROCKWOOL)

Mechanically fixed, horizontal junction to a window frame

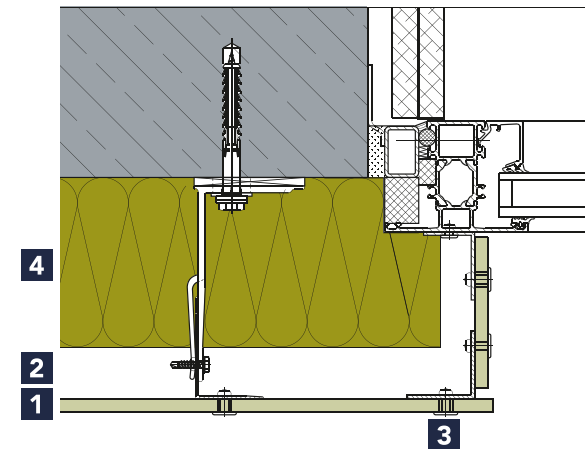

Detail 2-300

- 1** Rockpanel ≥ 8 mm
- 2** Ventilation
- 3** Rivet according to specifications
- 4** Insulation (for example ROCKWOOL)

Note:

Rockpanel cannot be used unventilated with aluminium support structures.

Attention:

For aluminium constructions in an open facade Rockpanel recommends a cavity depth of 40 mm - 100 mm.

Mechanically fixed, horizontal junction to a window frame, finished with a metal sheet

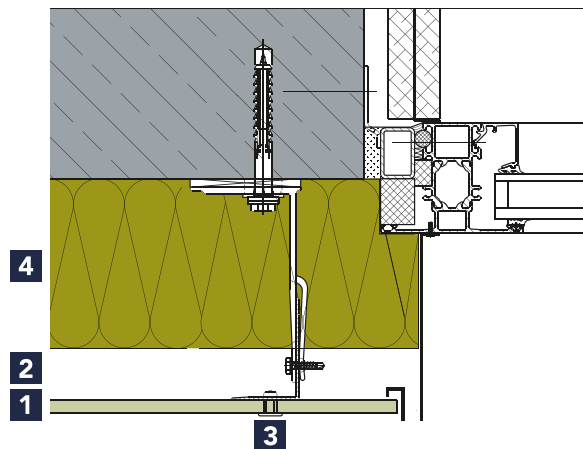

Detail 2-301

- 1** Rockpanel ≥ 8 mm
- 2** Ventilation
- 3** Rivet according to specifications
- 4** Insulation (for example ROCKWOOL)

Mechanically fixed, vertical junction over window frame

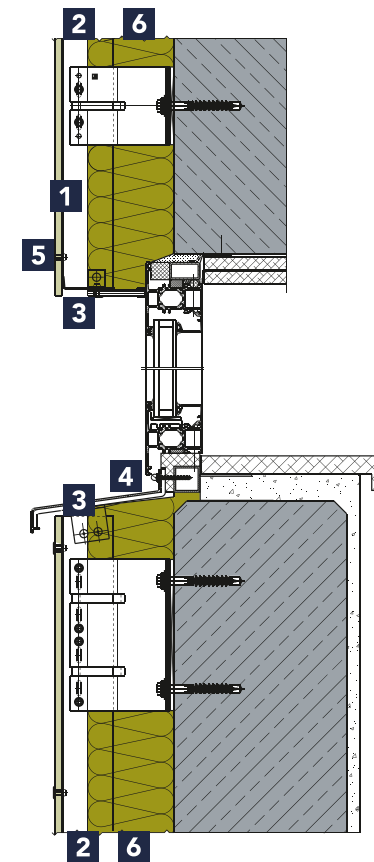

Detail 2-350

- 1** Rockpanel ≥ 8 mm
- 2** Ventilation
- 3** Ventilation profile / ventilated opening
- 4** Aluminium window-sill with bulkhead
- 5** Rivet according to specifications
- 6** Insulation (for example ROCKWOOL)

Facade

Aluminium
sub-construction

Vertical section over window frame with aluminium substructure with metal reveal

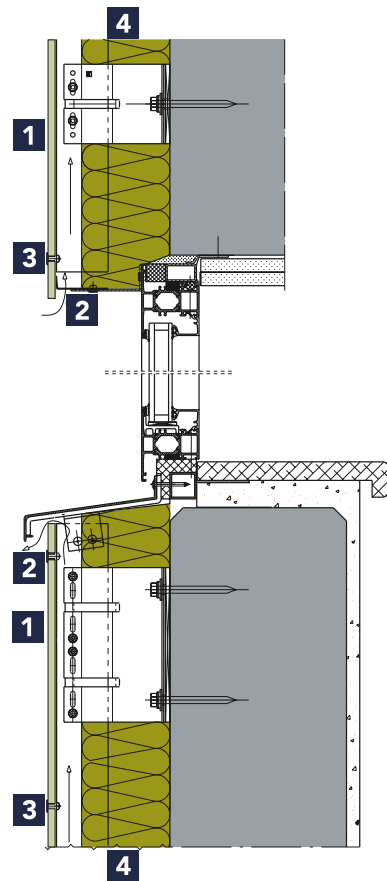

Detail 2-351

- 1** Rockpanel ≥ 8 mm
- 2** Ventilation
- 3** Rivets according to specifications
- 4** Insulation (for example ROCKWOOL)

Mechanically fixed, vertical cross section at flat roof

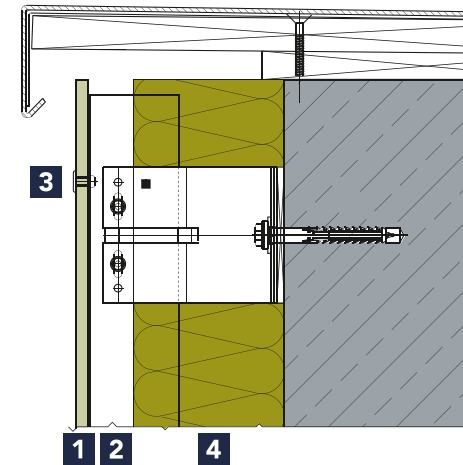

Detail 2-500

- 1** Rockpanel ≥ 8 mm
- 2** Ventilation
- 3** Rivet according to specifications
- 4** Insulation (for example ROCKWOOL)

Concealed fixing, abutting detail pavement

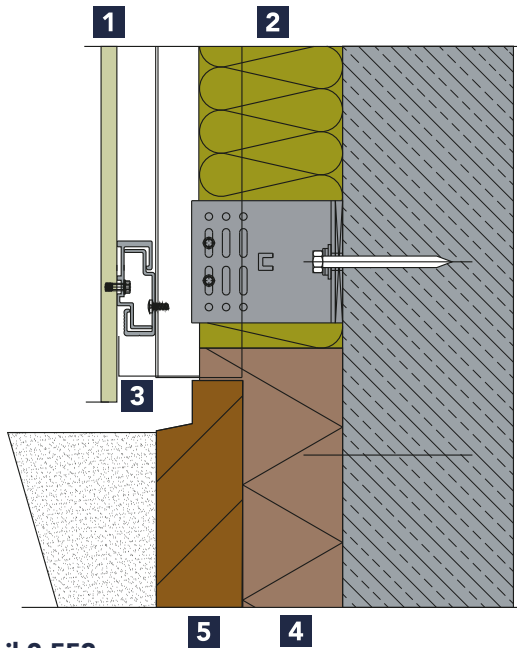

Detail 2-553

- 1** Rockpanel 11 mm
- 2** Insulation (for example ROCKWOOL)
- 3** Insect mesh
- 4** Insulation
- 5** Wall base plinth

Mechanical fixing – ETICS

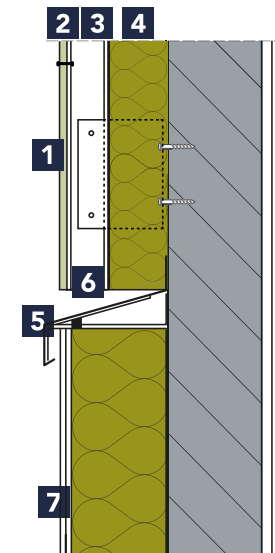

Detail 2-275

- 1** Rockpanel ≥ 8 mm
- 2** EPDM gasket
- 3** Rail support / ventilation
- 4** Insulation (for example ROCKWOOL)
- 5** Flashing
- 6** Ventilation
- 7** ETICS system according to external manufacturer

Facade

Aluminium
sub-construction

Mechanically fixed, junction to ETICS

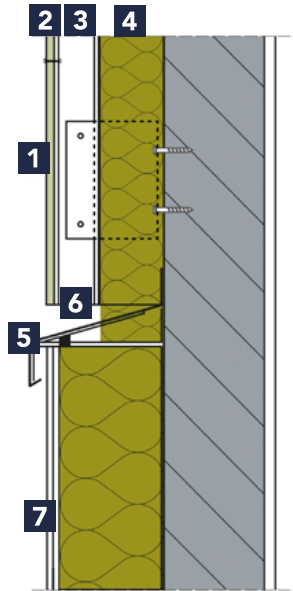

Detail 2-276

- 1** Rockpanel ≥ 8 mm
- 2** EPDM gasket
- 3** Rail support / ventilation
- 4** Insulation (for example ROCKWOOL)
- 5** Insect mesh
- 6** Flashing
- 7** ETICS system according to external manufacturer

Facade

Timber
sub-construction

Mechanically fixed to timber support, with vertical joints

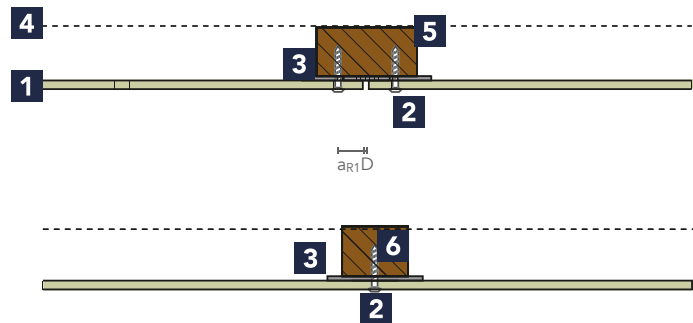

Detail 1-200

- 1** Rockpanel ≥ 6 mm
 - 2** Rockpanel screw
 - 3** EPDM gasket
 - 4** Breathable membrane
 - 5** Battens $\geq 28 \times 70$ mm
 - 6** Battens $\geq 28 \times 45$ mm
- D Assembly joint
 $a_{R1} \geq 15$ mm edge distance

Mechanically fixed to timber supports, internal and external corner

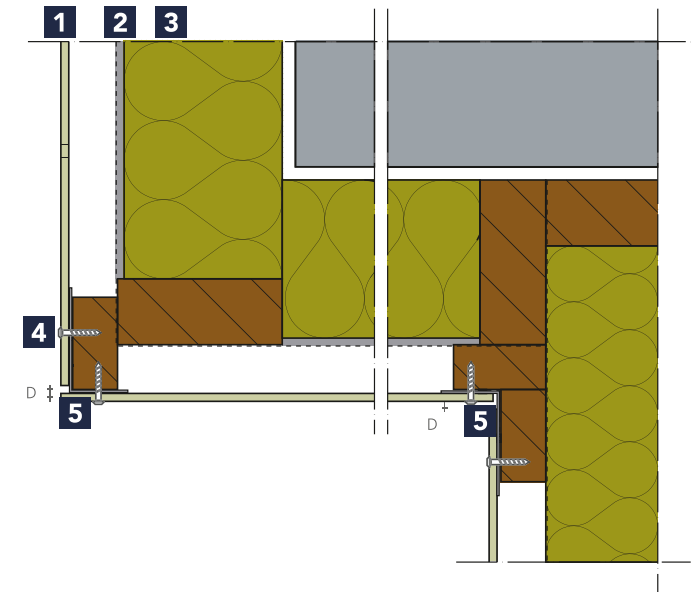

Detail 1-201

- 1** Rockpanel ≥ 6 mm
 - 2** Breathable membrane
 - 3** Insulation (for example ROCKWOOL)
 - 4** Rockpanel screw
 - 5** EPDM gasket
- D Assembly joint

Facade

Timber
sub-construction

**Mechanically fixed to timber supports,
with vertical joints with vertical interme-
diate fastening using a Rockpanel Strip**

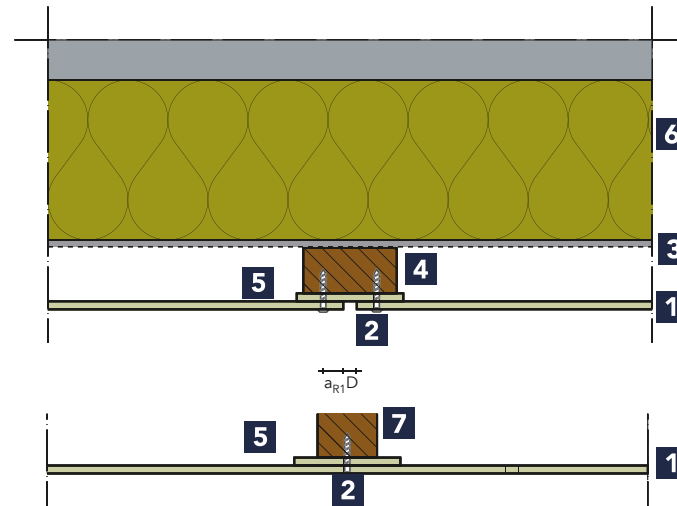

Detail 1-203

- 1** Rockpanel ≥ 6 mm
- 2** Rockpanel ring shank nail 40 mm
- 3** Breathable membrane
- 4** Battens $\geq 28 \times 70$ mm
- 5** Rockpanel Strip (Edge distance on both sides 15 mm)
- 6** Insulation (for example ROCKWOOL)
- 7** Lat $\geq 28 \times 45$ mm, D Assembly joint
 $a_{R1} \geq 15$ mm edge distance

Note: The hammer-in or screw-in depth is reduced for attachment on Rockpanel strips. Use the 40 mm nail for sufficient screw-in depth.

**Adhesive installation on timber
sub-construction with
Rockpanel strips**

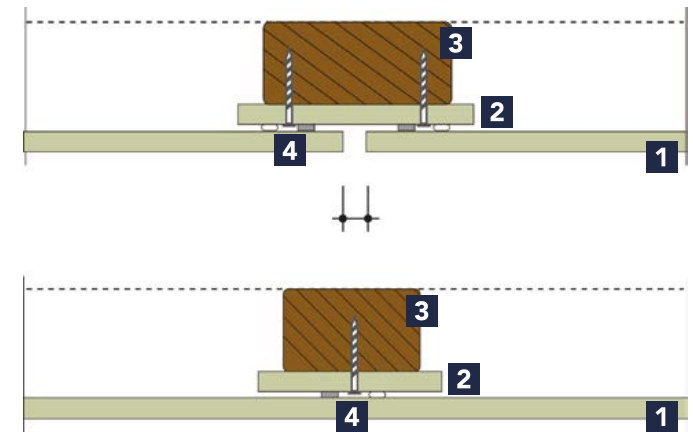

Detail 1-204

- 1** Rockpanel 8 mm
- 2** Rockpanel Tack S
- 3** Battens $\geq 28 \times 70$ mm
- 4** Rockpanel screw

**Mechanically fixed to timber supports,
with vertical external aluminium corner
profile**

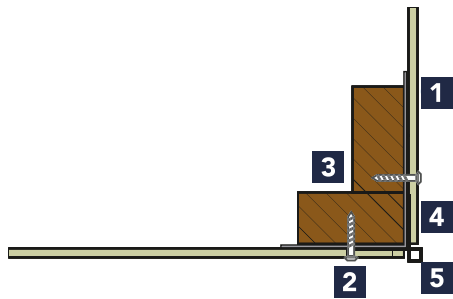

Detail 1-208

- 1** Rockpanel ≥ 6 mm
- 2** Rockpanel screw
- 3** Battens $\geq 28 \times 70$ mm
- 4** EPDM gasket
- 5** Rockpanel corner profile type D

**Mechanically fixed,
junction to ETICS**

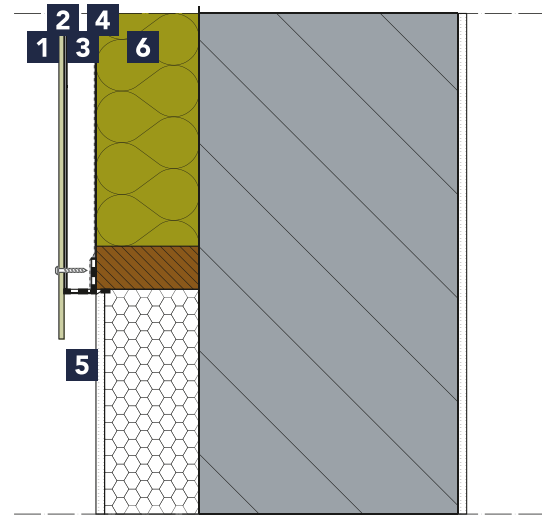

Detail 1-275

- 1** Rockpanel ≥ 8 mm
- 2** EPDM gasket
- 3** Rail support / ventilation
- 4** Breathable membrane
- 5** Ventilation profile
- 6** Insulation (for example ROCKWOOL)

Facade

Timber
sub-construction

**Mechanically fixed to timber supports,
horizontal window-frame junction
with profile**



Detail 1-302

- 1** Rockpanel ≥ 8 mm
 - 2** Wooden frame
 - 3** Breathable membrane
 - 4** Insulation (for example ROCKWOOL)
 - 5** Clearance of prefab element
 - 6** PU foam
 - 7** EPDM gasket
 - 8** Rockpanel screw
 - 9** Profile F
- D Assembly joint
 $a_{R1} \geq 15$ mm edge distance

**Mechanically fixed, on timber
sub-construction, horizontal cross
section at window frame junction**

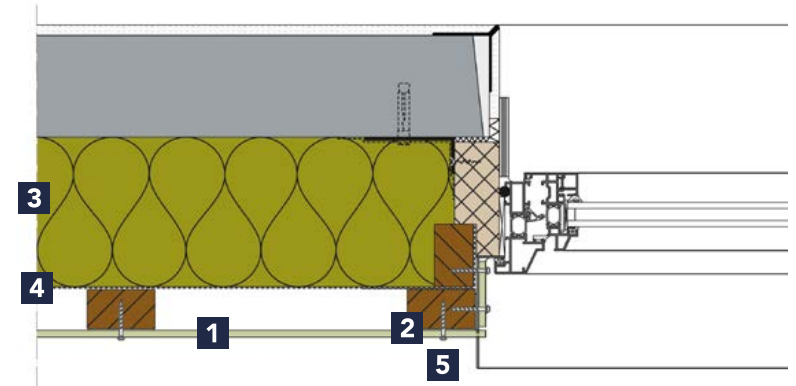

Detail 1-307

- 1** Rockpanel ≥ 8 mm
 - 2** EPDM gasket
 - 3** Insulation (for example ROCKWOOL)
 - 4** Breathable membrane
 - 5** Rockpanel screw
- D Corner profile
 $a_{R1} \geq 15$ mm edge distance

Mechanically fixed to timber supports, vertical junction at window-sill

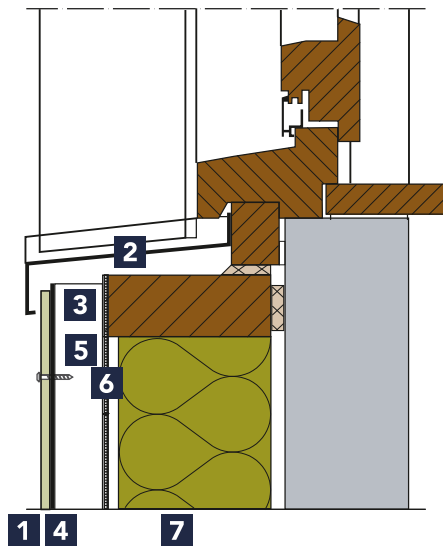

Detail 1-350

- 1** Rockpanel ≥ 8 mm
- 2** Aluminium window-sill with bulkhead
- 3** Ventilation
- 4** EPDM gasket
- 5** Battens
- 6** Breathable membrane
- 7** Insulation (for example ROCKWOOL)

Mechanically fixed to timber supports, junction at window head

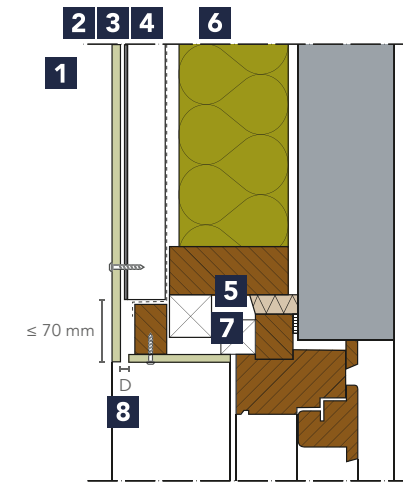

Detail 1-351

- 1** Rockpanel ≥ 8 mm
 - 2** EPDM gasket
 - 3** Battens
 - 4** Breathable membrane
 - 5** Framework
 - 6** Insulation (for example ROCKWOOL)
 - 7** PU foam
 - 8** Rockpanel ring shank nail or screw
- D Assembly joint

Facade

Timber
sub-construction

Mechanically fixed, on timber sub-construction, vertical cross section junction at window-sill

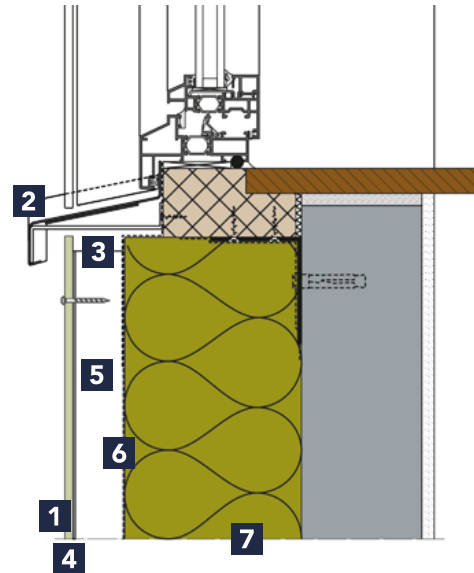

Detail 1-361

- 1** Rockpanel ≥ 8 mm
- 2** Aluminium window-sill with drip edge
- 3** Ventilation opening
- 4** EPDM gasket
- 5** Vertical battens
- 6** Breathable membrane
- 7** Insulation (for example ROCKWOOL)

Mechanically fixed, connection at ground level

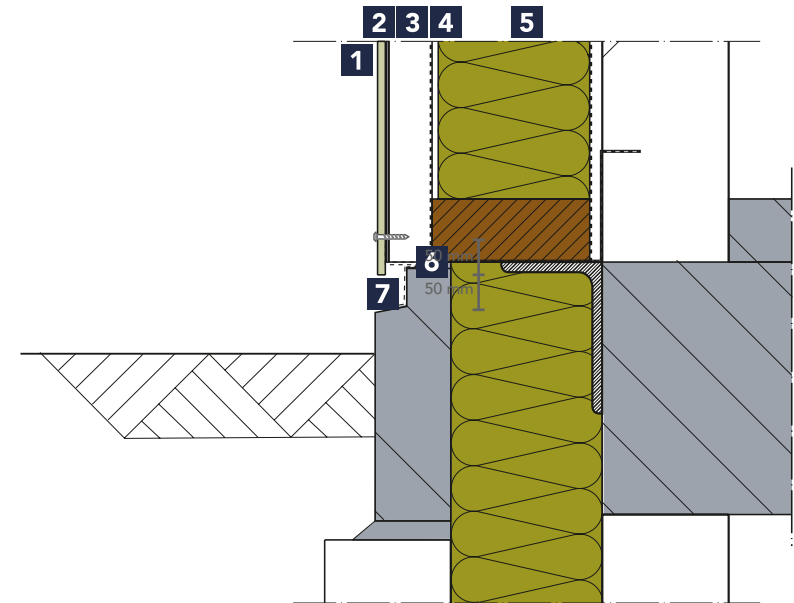

Detail 1-552

- 1** Rockpanel ≥ 8 mm
- 2** EPDM gasket
- 3** Battens / ventilation
- 4** Breathable membrane
- 5** Insulation (for example ROCKWOOL)
- 6** Flashing / cavity tray
- 7** Ventilation profile

Mechanically fixed, junction to a plaster wall

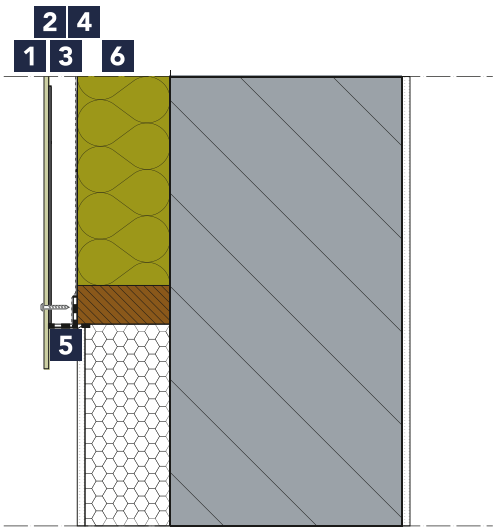

Detail 1-554

- 1** Rockpanel ≥ 8 mm
- 2** EPDM gasket
- 3** Battens / ventilation
- 4** Breathable membrane
- 5** Ventilation profile
- 6** Insulation (for example ROCKWOOL)

Sustainable construction

BRE certified construction



The detail given above is 1 of the 16 BRE certified constructions with Rockpanel cladding material based on Certificate of Approval Environmental Profiles No: ENP 427. Contact Rockpanel for more information and other BRE certified CAD drawings.

Vertical cross section of a ventilated facade on a timber sub-construction

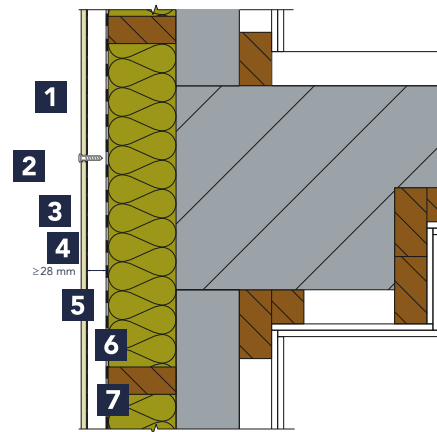

Detail 1-654

- 1** Rockpanel ≥ 8 mm
- 2** Rockpanel Torx screw
- 3** EPDM gasket
- 4** Timber battens
- 5** Breathable membrane
- 6** Insulation (for example ROCKWOOL)
- 7** Horizontally laid timber batten

Roofline

New build

Mechanically fixed to timber supports, fascia board new build

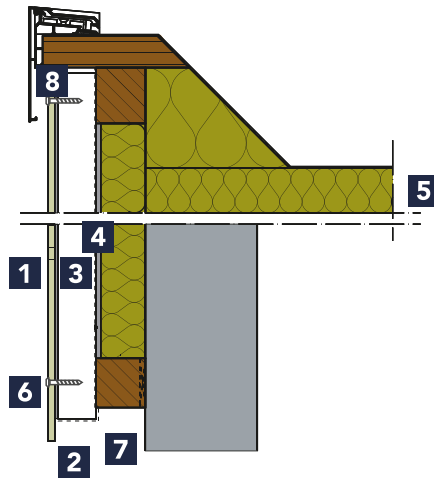

Detail 1-501

- 1** Rockpanel 6 or 8 mm
- 2** EPDM gasket
- 3** Battens ≥ 28 mm
- 4** Breathable membrane
- 5** Insulation (for example ROCKWOOL)
- 6** Rockpanel ring shank nail or screw
- 7** Ventilation profile
- 8** Ventilation joint

Mechanically fixed to timber supports, soffit board new build

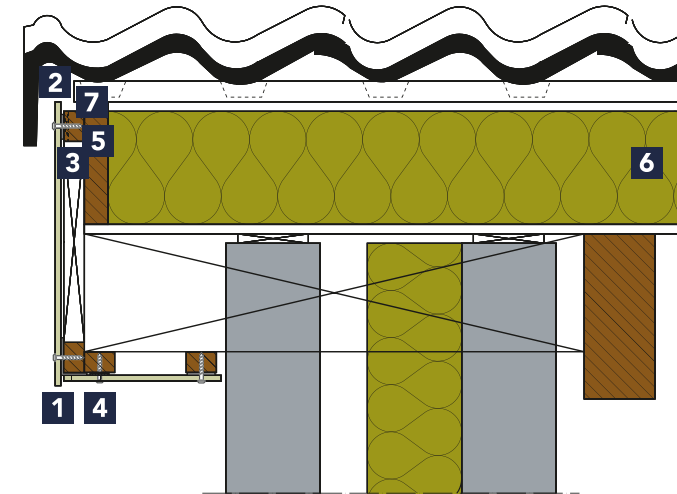

Detail 1-509

- 1** Rockpanel 6 or 8 mm
- 2** Ventilation joint
- 3** EPDM gasket
- 4** Rockpanel screw
- 5** Battens
- 6** Insulation (for example ROCKWOOL)
- 7** Ventilation gap in horizontal battens

Roofline

Renovation

Mechanically fixed to timber supports, fascia board renovation

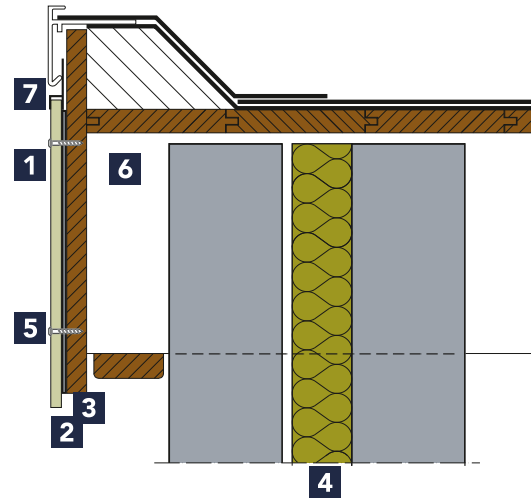

Detail 1-504B

- 1** Rockpanel 6 or 8 mm
- 2** EPDM foam gasket
- 3** Timber fascia board (in healthy condition)
- 4** Insulation (for example ROCKWOOL)
- 5** Rockpanel screw
- 6** Ventilation
- 7** Chair profile

Mechanically fixed to timber supports, soffit board renovation

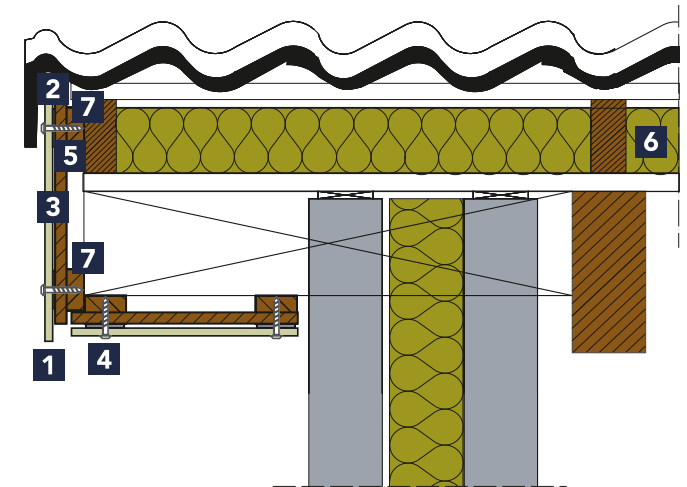

Detail 1-511

- 1** Rockpanel 6 or 8 mm
- 2** Ventilation (existing)
- 3** EPDM foam gasket
- 4** Rockpanel screw
- 5** Existing multi-ply cladding (in healthy condition)
- 6** Insulation (for example ROCKWOOL)
- 7** Ventilation gap in horizontal battens

Attention:

An EPDM foam gasket should be provided to ensure watertight connections at the point where the Rockpanel sheet is fixed over the existing subframe.

Detailing

Non-ventilated applications

Mechanically fixed to timber support, non-ventilated infilling

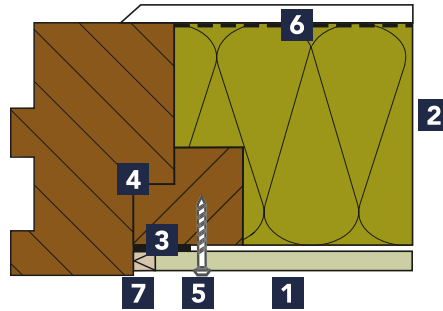

(horizontal)

Detail 1-400

- 1** Rockpanel Colours (without ProtectPlus) 6 or 8 mm
- 2** Insulation (for example ROCKWOOL)
- 3** Non-sticking layer, for example PE-foil
- 4** Battens
- 5** Rockpanel screw
- 6** Vapour barrier, $s_d > 10$ m
- 7** Sustainable weather resistant and elastic sealant

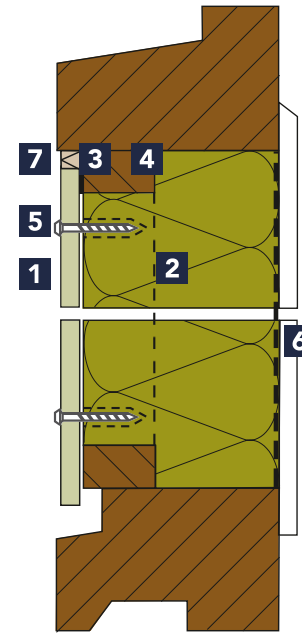

(vertical)

Detail 1-450

Attention:

Pre-conditions for non-ventilated applications see page 15.

Accessories

Mechanical fixing

Fixing method	Suitable for Rockpanel	Colour
Ring Shank nails 27 mm	Lines ² 10 mm	Stainless Steel
Ring Shank nails 32 mm	Natural / Chameleon / Ply	Stainless Steel
	Uni	Standard Colours
	Colours	Standard, Special and Custom Colours
	Woods / Stones / Metals	Woods / Stones / Metals
HP Nail 35 mm	Natural / Chameleon / Ply	Stainless Steel
	Uni	Standard Colours
	Colours	Standard, Special and Custom Colours
	Woods / Stones / Metals	Woods / Stones / Metals
Screws 35 mm	Natural / Chameleon / Ply	Stainless Steel
	Uni	Standard Colours
	Colours	Standard, Special and Custom Colours
	Woods / Stones / Metals	Woods / Stones / Metals

Adhesive system

	Quantity	Indicative usage per 100 m ²
Rockpanel Tack-S (certified)	290 ml	50 cartridges
Primer MSP Transparent for the back of the boards	500 ml	6 cans
Prep M Primer for aluminium sub-construction	500 ml	2 cans
Foam tape (double sided)	25 m ¹	12 rolls
Cleaner liquid 1	1 ltr	1 can

Concealed fixing

Combined with our Rockpanel Premium A2 board in thickness 11 mm, you can use the concealed fixing system.

Concealed fixing	Quantity
Blind fastener TU-S-6x 11-A4*	500 pcs per box
Blind fastener TU-S-6x 13-A4**	500 pcs per box
HSS-Drill bit 6,0 x 43,5	1 piece
Depth locator for drill bit universal	1 piece

* for use with a 3 mm panel clip
 ** for use with a 5 mm panel clip

Other accessories





















Article	Width	Quantity
EPDM Foamtape (adhesive)	36 mm	50 m ¹
EPDM Foamtape (adhesive)	60 mm	50 m ¹
EPDM Foamtape (adhesive)	80 mm	50 m ¹
EPDM Foamtape (adhesive)	100 mm	25 m ¹
EPDM Foamtape (adhesive)	130 mm	25 m ¹
Rockpanel Graffiti Cleaner		780 ml
Rockpanel Edge paint (only Rockpanel Colours)*		780 ml

* Special and Custom Colours are only available in combination with Rockpanel Boards. For painting the edges of Woods, Stones, Metals and Chameleon, we advise RAL 9005 (black).

Profiles

















High quality aluminium External Corner profiles, Edge profiles, Joint profiles and Starter profiles can be supplied in almost every RAL/NCS colour. Please contact Rockpanel for details of your local supplier.

Aluminium profiles – Rockpanel boards

Standard length 3055 mm		Colours	Profile size*
	Profile A		Blanc anodised Standard Special/Custom
	Profile B		Blanc anodised RAL 9005 / RAL 9010
	Profile C		Blanc anodised Standard Special/Custom
	Profile D		Blanc anodised Standard Special/Custom
	Profile E		Blanc anodised Standard Special/Custom
	Profile F		Blanc anodised Standard Special/Custom
	Profile G		Blanc anodised Standard Special/Custom
	Profile H		Blanc anodised Standard Special/Custom
	Profile I		Blanc anodised
	Profile J		Blanc anodised

* Boards in 9 mm thickness (A2), require a 10 mm profile.

Aluminium profiles – Rockpanel Lines²

Standard length 3055 mm		Colours	Profile size
	Profile C		Blanc anodised Standard Special/Custom
	Profile D		Blanc anodised Standard Special/Custom
	Profile E		Blanc anodised Standard Special/Custom
	Profile F		Blanc anodised Standard Special/Custom
	Profile H		Blanc anodised Standard Special/Custom
	Profile I		Blanc anodised
	Profile J		Blanc anodised
	Profile K*		Blanc anodised

Please ensure with the supplier the suitability of their fixings to meet our technical requirements. Working with accessories from other manufacturers should be carried out according to their recommendations, their supervision and their warranty conditions.

* For easy connection at ground level, a Rockpanel starting profile (type K) can be used for placement of the lowest section of Rockpanel Lines².

Feature	Note	PLANKS			BASIC APPLICATIONS		NATURE FACADES		
		Rockpanel Lines ²	Rockpanel Uni	Rockpanel Ply	Rockpanel Natural	Rockpanel Woods	Rockpanel Stones		
APPLICATION									
High facades*	Height > 18 m					■	■	■	
Low facades	Height < 10 m	■	■	■	■	■	■	■	■
Detailed solutions for roofs		■	■	■					
AESTHETICS									
Type of cladding									
Board			■	■	■	■	■	■	■
Tongue and groove		■							
Weatherboarding	(EasyFix only for Durable or two visible attachments)						■	■	■
Dimensions									
Standard dimensions (mm)	2500x1200/3050x1200		■	■	■	■	■	■	■
Standard dimensions (mm)	3050x164/3050x295	■							
Customised dimensions						■ optional	■ optional	■ optional	
Special width (mm)	1250					■	■	■	
Thickness (mm)		10	6	8 & 10	10	8	8	8	
Surface									
Untreated					■				
Primer		■		■					
Coloured surface		■	■				Woods look	Stone look	
Customised surface							■	■	
ProtectPlus protective coating	Matt								■
ProtectPlus protective coating	Silk matt								■
ProtectPlus protective coating	High gloss								■
Maintenance									
Can be painted		■	■ light	**	***				
Self-cleaning							■	■	
Fixing methods									
Invisible fixing	Mechanically	■							
	Adhesive						■	■	■
Screws			■	■	■	■	■	■	■
Nails			■	■	■	■	■	■	■
Rivets					■	■	■	■	■
FIRE SAFETY									
European fire class	B-s2,d0	■	■	■	■	■	■	■	■
	A2-s1,d0						■ optional	■ optional	

* For all medium and high rise buildings, we recommend the use of our A2 grade boards (A2-s1,d0).
** Maintenance for Rockpanel Ply depends on the paint chosen. Please contact the paint manufacturer.
*** Rockpanel Natural boards age naturally; for further information see the product data sheet.

DESIGN FACADES

PREMIUM FACADES

Feature	Note	Rockpanel Colours	Rockpanel Colours ProtectPlus	Rockpanel Metals	Rockpanel Chameleon	Rockpanel Premium
APPLICATION						
High facades*	Height >18 m	■	■	■	■	■
Low facades	Height < 10 m	■	■	■	■	■
Detailed solutions for roofs		■	■			
AESTHETICS						
Type of cladding						
Board		■	■	■	■	■
Tongue and groove						
Weatherboarding	(EasyFix only for Durable or two visible attachments)	■	■	■	■	
Dimensions						
Standard dimensions (mm)	2500x1200/3050x1200	■	■	■	■	■
Standard dimensions (mm)	3050x164/3050x295					
Customised dimensions		■ optional	■ optional	■ optional	■ optional	■
Special width (mm)	1250	■	■	■		■
Thickness (mm)		6 & 8	8	8	8	9
Surface						
Untreated						
Primer						
Coloured surface		■	■	■	■	■
Customised surface						■
ProtectPlus protective coating	Matt					■
ProtectPlus protective coating	Silk matt		■	■		■
ProtectPlus protective coating	High gloss				■	■
Maintenance						
Can be painted		■				
Self-cleaning			■	■	■	■
Fixing methods						
Invisible fixing	Mechanically					■
	Adhesive	■	■	■	■	
Screws		■	■	■	■	
Nails		■	■	■	■	
Rivets		■	■	■	■	■
FIRE SAFETY						
European fire class	B-s2,d0	■	■	■	■	
	A2-s1,d0	■ optional	■ optional	■ optional	■ optional	■

**rockpanel.
co.uk**

The Rockpanel website is designed to be an easy-to-use resource for those wishing to find out more about our products. Its clear navigation ensures that you have access to a wealth of information and your questions can be answered.

Specifications

Select the relevant specification along with the selected material to match your product finish, colour and accessory requirements. All specifications are downloadable on www.rockpanel.co.uk.

Building Information Modelling

Building Information Modelling (BIM) is an important aspect of the planning and implementation of construction projects. In order to help with this process, the Rockpanel website provides BIM data files for the full range of our sustainable facade panels, which you can access and insert into digital building models. The BIM data files can be downloaded from the website.

CAD drawings

Rockpanel offers a wide range of CAD drawings online. The drawings are easy to download in PDF, DXF and DWG files and illustrate clearly how specific design details can be produced.

Sample request

On the Rockpanel website www.rockpanel.co.uk you can easily request your sample.

References

- Register to receive 4 e-mails a year containing Rockpanel reference projects from across the globe.
- Go to the "Inspiration" section on our website for more stimulating projects!

ETA and CE marking

With regard to the EOTA procedure for innovative products, Rockpanel boards have been evaluated and approved in accordance with the European Assessment Document (EAD) no. 090001-00-0404. On the basis of this guideline Rockpanel products have received a European Technical Assessment (ETA).

With regard to the ETA all products have a declaration of performance and CE marking thereby fully complying with the construction product regulations in the UK and Europe.

ETA and description:

- ETA-18/0883:
Rockpanel Premium A2 11 mm
- ETA-13/0340:
Rockpanel Colours and ProtectPlus A2 9 mm
- ETA-07/0141:
Rockpanel Colours and ProtectPlus Durable 8 mm
- ETA-08/0343:
Rockpanel Colours Durable 6 mm
- ETA-13/0648:
Rockpanel Durable Natural 10 mm
- ETA-13/0204:
Rockpanel Lines² 8 and 10 mm
- ETA-13/0019:
Rockpanel Ply 8 mm and 10 mm
- ETA-17/0619:
Rockpanel Uni 6 mm



The greatest possible care has been taken in the design and composition of this guide. Nevertheless, we cannot guarantee the completeness and correctness of the information included herein. Price and product changes are reserved. Illustrations, colours, descriptions and information relating to dimensions, characteristics etc. apply only by approximation and are not binding. All of the information in this guide is protected by copyright. This guide, the texts, photos, other information included therein and/ or parts thereof may not be reproduced, modified or published without the prior written approval of Rockpanel.

BUILDING INSPIRATIONS



www.rockpanel.co.uk

Learn more about us, ask for product samples and be inspired by attractive reference projects.



www.facebook.com/rockpanel

Be the first to discover our latest international projects.



www.twitter.com/rockpanel

Follow us for the latest news and updates.



Engage and interact.



www.instagram.com/rockpanel

Get inspired.