

CEIDRAL



The world of Facades



FIBRE CEMENT FACADES
FIXING GUIDE



Cedral Lap and Cedral Click

With the visual appeal of natural timber, simplicity of installation and resistance to rot, Cedral is an attractive, low maintenance alternative to all types of weatherboard.

Cedral board

Cedral board helps you to create an attractive, consistent look down to the very last detail.

They can be used to cover roof edges, reveals and other facade elements to match or contrast your facade.

CONTENTS

4	Product features	20	Installing Cedral Lap – horizontal
5	Cedral Lap and Cedral Click	44	Installing Cedral Click – horizontal
6	Dimensions and properties	56	Vertical installation
7	System principle	80	Installing Cedral soffits and fascias
8	Colours	86	Preventing efflorescence
10	Accessories		
12	Storage and handling		
14	General fixing information		

Product features



EASY TO INSTALL



LOW MAINTENANCE



RESISTANT

Resistant to rot and immune to attack by pests and insects



EXCELLENT FIRE PERFORMANCE

EN 13501-1 fire performance classified to A2-s1, d0



UV RESISTANT



FACTORY APPLIED COLOUR



CEDRAL LAP

Cedral Lap is specially designed so the planks are overlapped when installed to create a traditional clapboard aesthetic on your facade.

CEDRAL CLICK & CEDRAL CLICK SMOOTH

Cedral Click is a tongue and groove cladding material creating a modern, flush-fitting facade.

Dimensions & properties

DIMENSIONS	CEDRAL LAP	CEDRAL CLICK
Length	3600mm	3600mm
Width	190mm	186mm
Thickness	10mm	12mm
Weight per board	11.2kg	12.2kg
Planks per m ²	1.75*	1.60
Cover width	160mm*	174mm
Pallet dimensions	3600 x 1106 x 360mm	3600 x 1106 x 360mm
Pallet weight	1580kg	1800kg

* Undulating planks 2.24 per m², flat method 1.45 per m²
If the cover width of Cedral Lap is decreased to 150mm, 1.86 per m²

PROPERTIES (AIR DRY)	CEDRAL LAP	CEDRAL CLICK
Installed weight	19.3kg/m ²	19.47kg/m ²
Density	1300kg/m ³	1300kg/m ³
Bending strength:		
Longitudinal	23N/mm ²	23N/mm ²
Transverse	11N/mm ²	11N/mm ²
Modus of elasticity:		
Longitudinal	7500N/mm ²	7500N/mm ²
Transverse	5500N/mm ²	5500N/mm ²
Expansion from dry air to saturated	1.75mm/m	1.75mm/m
Thermal conductivity	0.212W/mK	0.212W/mK
Reaction to fire: Building Regulations EN13501-1	A2-s1, d0	A2-s1, d0

System principle: ventilated rainscreen

Cedral Lap and Cedral Click are installed to the ventilated rainscreen principle. This means air can flow in at the base of the system, behind the cladding and then out, over the top of the Cedral weatherboard system.

A minimum 30mm ventilation gap must be left behind the boards with a minimum 10mm continuous gap left at the top and bottom of the system for full circulation. This includes above and below any openings or obstacles such as windows and doors

The air flow behind the Cedral weatherboard enables the system to remove moisture. Impeding this process could lead to moisture problems within the system.

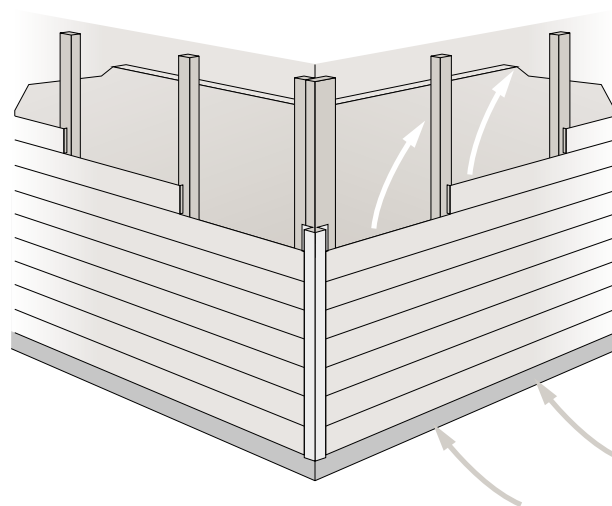

The Cedral Collection

Design Collection a modern statement

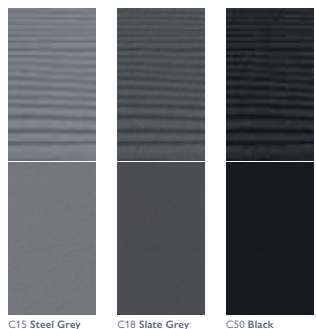

Natural Collection making nature part of the home



Expressive Collection creating a characterful home

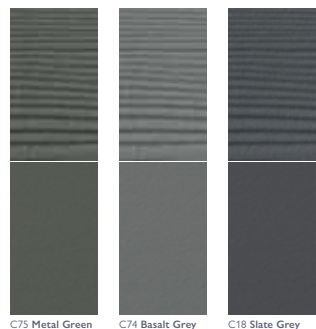

Classic Collection the epitome of elegance



The Design Collection is available in Cedral Lap Wood, Cedral Click Wood and Cedral Click Smooth.

The Natural Collection is available in Cedral Lap Wood and Cedral Click Wood. Cedral Click Smooth is available subject to extended lead times.

The Expressive Collection is available in Cedral Lap Wood and Cedral Click Wood. Cedral Click Smooth is available subject to extended lead times.

The Classic Collection is available in Cedral Lap Wood and Cedral Click Wood. Cedral Click Smooth is available subject to extended lead times.

Accessories

TOUCH UP PAINT

Cedral touch up paint is available in 0.5 litre quantities for all colours. This should be applied only to cut edges or for very small artificial scratches on the front face of the planks, applied sparingly using something like a small artists brush. Any overspill should be removed immediately with a clean and dry microfibre cloth.

ALUMINIUM TRIMS

Supplied in 3m lengths (horizontal and vertical applications) and colours to match and complement the Cedral range* (Perforated closures are 2.5m in length).



* Cedral Click Start profiles are not colour matched

CEDRAL LAP SCREWS

The use of Cedral Lap screws is recommended when installing Cedral Lap onto timber battens. For metal framing different fixings to suit are available. Size Minimum 4.0 x 45mm. Supplied in boxes of 250.



CEDRAL COLOUR MATCHED SCREWS

The use of Cedral colour matched screws is recommended for all visible fixings into timber battens. Supplied in boxes of 100, size 4.8 x 38mm. 12mm dia. head.



CLICK CLIPS AND SCREWS

The use of Cedral Click Clips is required when installing Cedral Click. These are supplied complete with stainless steel screws in boxes of 250. For metal farming, Click Clips and rivets are available.



For your nearest

stockist, please

visit cedral.world

Storage and handling

STORAGE

Cedral should be stored under cover on the pallets on which they are supplied. Any temporary transportation hoods should be removed to release any trapped moisture and the pack re-covered with an opaque tarpaulin.

The planks should be protected from mud staining.

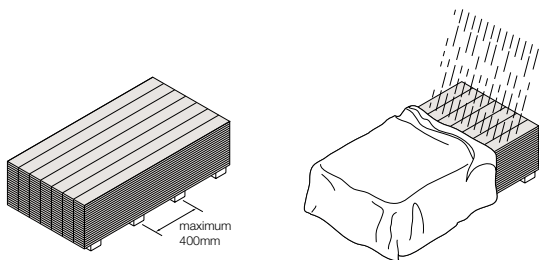

Ensure sufficient bearers, stack on a level surface and never stack against a wall

Must be protected from the weather

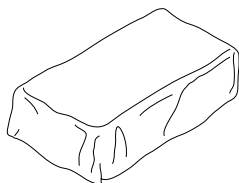

Store under cover, ideally inside

HANDLING

Care should be taken at all times when handling Cedral on the flat, as it can break. While Cedral is stored on the flat, it should be fully supported along its full length on purpose designed pallets. Manual handling is best carried out with the planks carried on their sides. When a single person is carrying a plank, it should be turned onto its side before being lifted off the stack, and then the handler must keep their hands as far apart as possible to provide maximum support for the board.

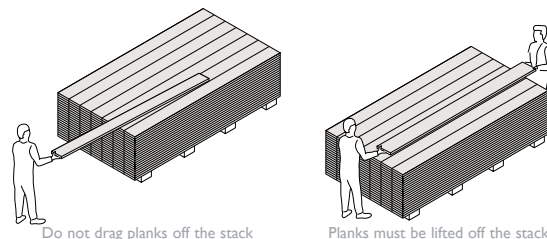

Do not drag planks off the stack

Planks must be lifted off the stack

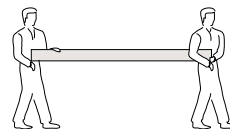

Carry on edge but do not store on edge

CLEANING

For minor soiling, washing with a mild household detergent or soft soap solution followed by rinsing with clear water is sufficient to maintain its appearance and colour. For chemical cleaning please contact the Technical department.

General fixing information

- 15 Cutting
- 16 Screwing
- 17 Nailing
- 18 Health and safety
- 18 Wind loading
- 18 Surface mounted features
- 19 Ventilation



Cutting

The method of cutting is dependent on the amount there is to be done. It is possible to cut the board with a handsaw, guillotine, electric jigsaw or circular saw.

After cutting, wipe away dust with a clean, dry cloth.

Do not cut when wet or damp, as the cutting dust will stick and stain.

Note: Cutting and drilling must take place in a dry and well ventilated environment.

GUILLOTINE

Cedral can be cut with a specially manufactured guillotine (recommended for Cedral Lap only).

ELECTRIC JIGSAW

Turning Cedral over and cutting on the reverse will ensure a clean finish on the front of the plank.

HAND HELD CIRCULAR SAW

A hand held circular saw with fibre cement blades is ideal for cutting large quantities. These are available from local suppliers.

A DIAMOND-DUSTED BLADE (RECOMMENDED)

A 4 tooth blade 180mm in diameter is recommended for cutting. Also with this method, cutting from the back of the board is advisable as the saw guide leaves marks across the board surface. Test cutting is recommended.

Screwing (recommended)

Screw fixing to the support structure is recommended and can be achieved without pre-drilling where fixings are at least 50mm from the end of the board. Where screws are to be within 50mm of the end of the board then a pre-drilled hole and countersink is required to suit the screw size. Screws must be stainless steel **min.** size 4.0 x 45mm.

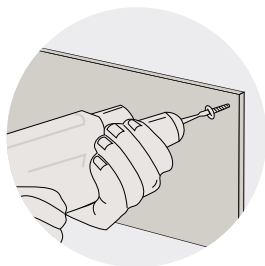

The following minimum distances from the edge to the screw and nail must be respected.

EDGE DISTANCE

D1 20mm

D2 20mm

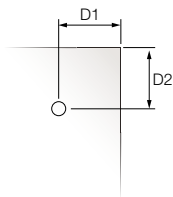

Nailing

PNEUMATIC NAILING

Cedral can be pneumatically nailed. There is a large selection of guns on the market. Stainless steel fixing is a must, as they last as long as the board.

The nail length should be minimum 45mm, diameter can be 2.5mm or 2.8mm, head 6 to 7mm diameter. A ring shank nail is preferred. Only round headed nails are allowed.

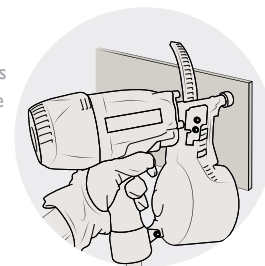

Trial nailing should be conducted to set the depth of the fixing. Respect the minimum 20mm edge distance.

Any pneumatic gun which is being considered, must be adjustable otherwise the nails could either be fired right through the board or left proud of the face of the board (check with manufacturer).

Nail head should lie flat on the plank surface and should not be **driven** or **sunken** into the plank.

NAILING BY HAND

The board can be hand nailed without pre-drilling when the nails are at least 50mm from the end of the board. For nails closer than 50mm to the end, nail positions need pre-drilling with a 3mm drill bit. Normal HSS drill bits can be used but they will need regular sharpening. Nails should be stainless steel ring shank, minimum size 2.8 x 45mm with 7-10mm head. Nail head should lie flat on the plank surface and should not be **driven** or **sunken** into the plank.

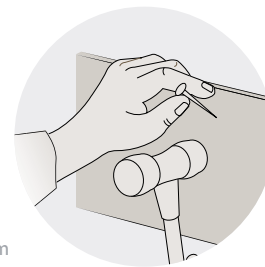

Health & safety

Dust can be released while the sheets are being processed which can irritate airways and eyes. Long-term exposure to dust can be harmful to health. For more information, please refer to the safety data sheet which can be found in the technical section for Cedral Facades at www.cedral.world.

High wind loading; very severe/severe exposure or exceptional impact loading requirements

Should wind loading exceed 1.0kN/m^2 , or where the exposure is classed as 'severe' or 'very severe', please consult the Technical Department. Where exceptional impact loads to the Cedral planks can be anticipated (i.e. low level applications near pedestrian access, schools, leisure facilities etc.) additional timber battens should be incorporated between the fixing battens, and an increased overlap (Cedral Lap) to increase the plank resistance.

Surface mounted features

Where other building features (i.e. signs, gutters, canopies etc.) are to be fixed then additional batten work should be included and clearance holes oversized by 3-5mm must be provided through the Cedral. Under no circumstances should the Cedral planks receive additional structural loads.



Ventilation

To avoid interstitial condensation, a minimum 30mm free flow cavity should be provided behind the Cedral with a minimum $10,000\text{mm}^2/\text{m}$ run of ventilation at the top and bottom of the facade, above and below windows and above doors.

The use of 38mm deep battens will provide the necessary cavity and will be of minimum sufficiency to resist the pull-out loads generated by the planks.

Installing Cedral Lap horizontally

- 21 Introduction
- 22 Batten fixing
- 23 Perforated closures
- 25 Vertical profiles
- 29 Horizontal profiles
- 31 Fixing method
- 38 Corner options
- 41 Finishing and decoration
- 42 Additional insulation

Introduction

There are a number of fixing variants for Cedral, but the general principle is the same for all.

Cedral needs to be fixed to vertical timber battens (preservative treated and planed on two faces) of at least 50mm wide (subject to site location), spaced at a maximum of 600mm across the elevation. Cedral should be fixed to at least three battens: if it is only fixed to two, then the batten spacing should be reduced to 400mm.

A minimum 30mm clear cavity must be provided behind Cedral with a 10mm continuous opening at the base, top and at the window and door heads and cills.

7 STEP INSTALLATION PROCEDURE

1. Fix battens to wall
2. Attach perforated closures to top and bottom of battens
3. Fix vertical profiles
4. Fix horizontal starter profiles
5. Cut and fix Cedral Lap planks
6. Corner options
7. Finishing and decoration

Batten fixing

POSITION AND FIX THE VERTICAL BATTENS*

If a breathable membrane is being installed, this should be behind the battens for the Cedral. Battens to be spaced a maximum of 600mm apart (reduce this in high windload areas).

BATTEN SIZES

- Standard fixing – 50mm x 38mm
- Joints/corners – 75mm x 38mm

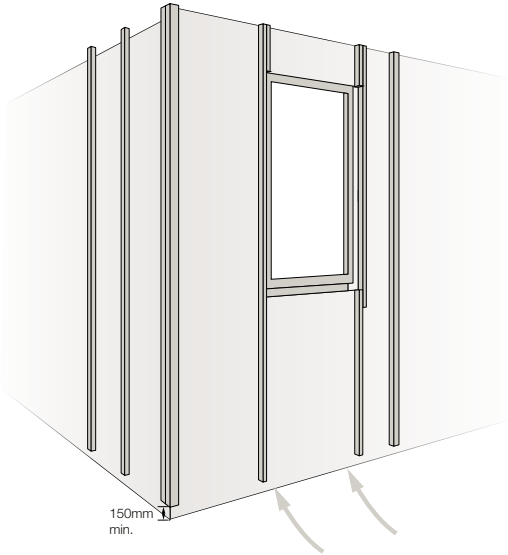

* For solid walls, timber frame and metal stud constructions it is good practice to include a breathable membrane behind the battens. Generally for unfilled/partially filled cavity walls there is no requirement to do this.

Perforated closures

ALUMINIUM FINISH 2.5M LENGTH

Perforated closures should be screwed or nailed to both the top and bottom of battens, at the cills and window/door heads, and at the top and bottom of the facade. They are designed to protect against birds, rodents and some insects whilst allowing air to flow through the system.

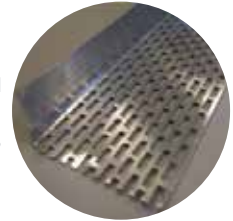

Perforated closure

Available in depths of 40mm, 50mm, 70mm and 100mm to allow for coverage of external insulation.

Allow 10mm continuous air gaps for the bottom and top of the facade, above and below windows and above doors. At least 25mm of the closure should be left open to the air, for example at window / door heads.

PERFORATED CLOSURE SHOWN AT WINDOW HEAD

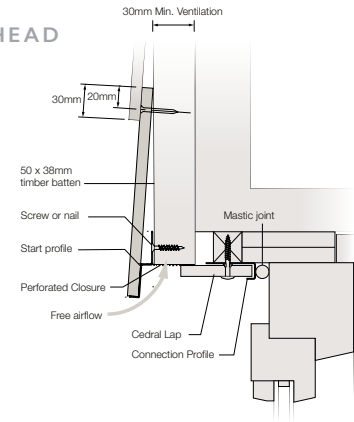

BASE OF CLADDING

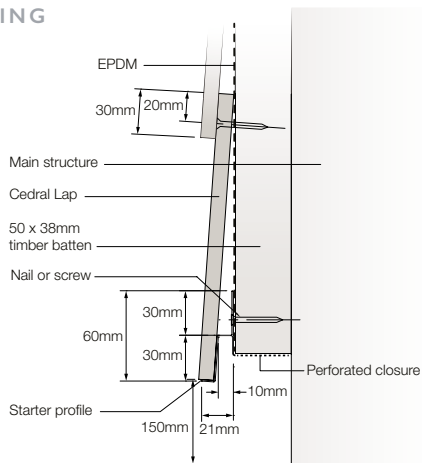

PLINTH DETAIL

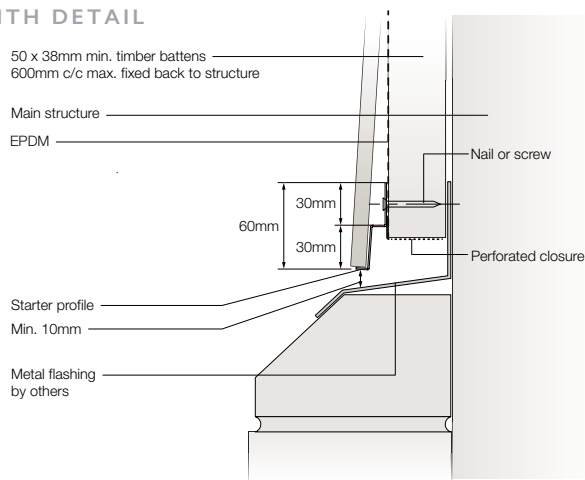

Vertical profiles

Cedral trims are 3m in length and manufactured to meet the required safety standards and have a guaranteed level of quality. They are colour matched to Cedral planks and branded on the reverse for easy identification.



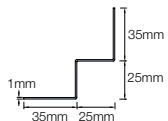

INTERNAL CORNER

To finish the corner where Cedral meets an internal corner forming a seal between the trim and the corner.

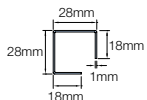

EXTERNAL CORNER JUNCTION

Used as a corner joining piece. Only available in black. 300mm length.

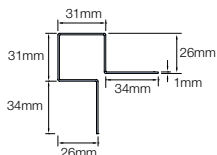

EXTERNAL CORNER (SYMMETRIC)

This universal trim can be used to provide protection on external corners and for stop profile applications.

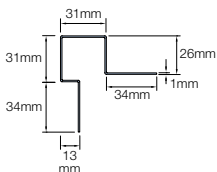

EXTERNAL CORNER/WINDOW REVEAL (ASYMMETRIC)

Used as an external corner on window reveals where detailing on a reveal is a single piece.

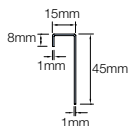

CONNECTION PROFILE

End trim to finish Cedral when used as a single piece on a window reveal or soffit.

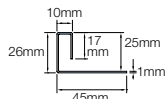

END PROFILE

To finish Cedral where installed in a lap configuration.

FIX VERTICAL PROFILES

Position, level then screw or nail end profiles, corner profiles and window profiles into place.

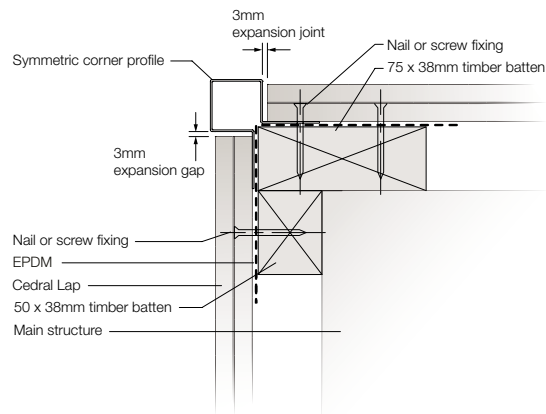
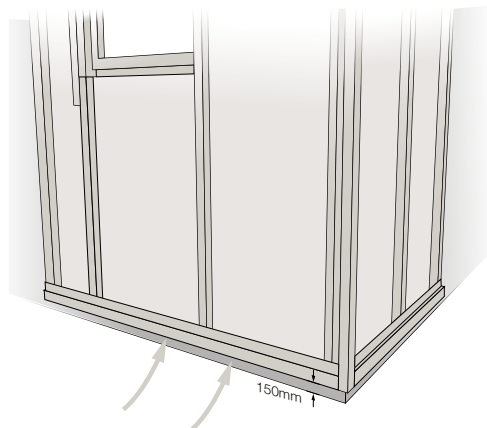

Horizontal profiles

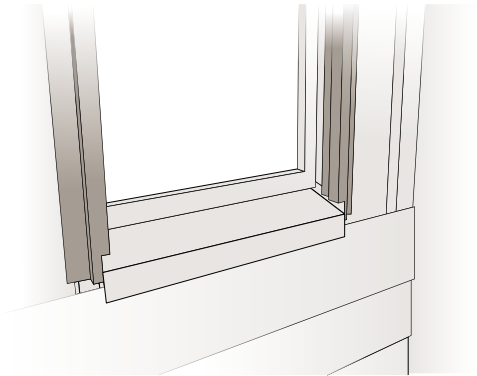

Fix external window (asymmetric) profiles to the sides of the window.

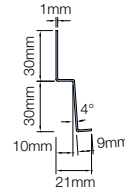

STARTER PROFILE

Used to start a cladding run with a lip to cover the first batten. 3m in length.

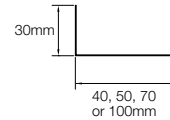

PERFORATED CLOSURE

Designed to protect against vermin and some insects while still allowing air to flow through the system. 2.5m in length.

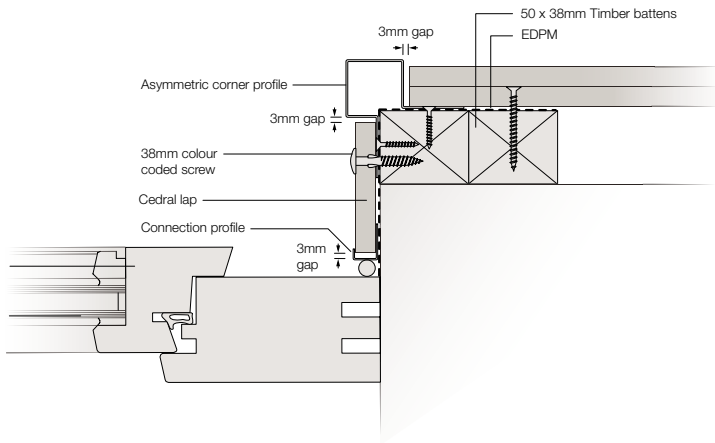

FIX HORIZONTAL STARTER PROFILES

Ensure starter profile is level then screw or nail into place. The starter profile will 'kick out' the first plank to ensure the look is uniform with the rest of the installation.

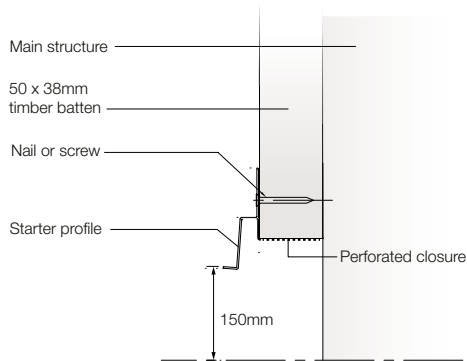
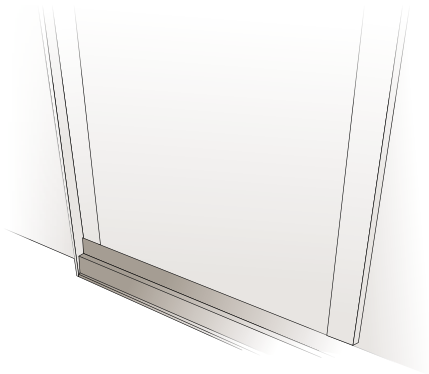

Fixing method

CHOOSE YOUR HORIZONTAL LAYING PATTERN

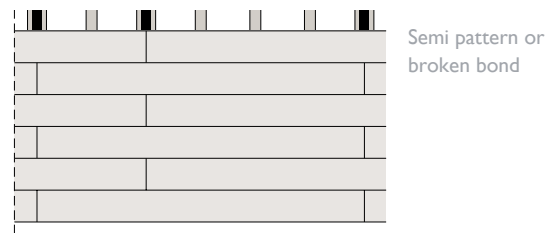
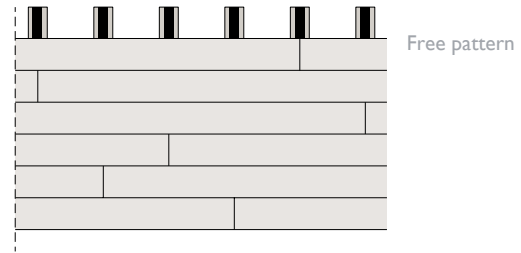
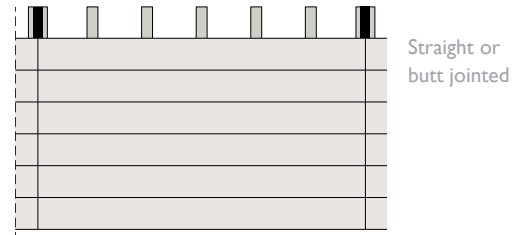

Note: When two planks of Cedral are joined together, a protective strip should be placed onto the batten to guard against moisture ingress. This is known as an EPDM strip.

START INSTALLATION

Place the first Cedral plank onto the starter profile. Ensure that the plank is fixed to every batten it crosses. The end of every plank must also coincide with a batten.

Allow at least 150mm between the bottom edge of Cedral and the ground.

Lengths of over 400mm must be fixed to at least 3 battens.

Fixings must be a minimum of 20mm from the edges of the Cedral plank:

EDGE DISTANCE

D1 20mm

D2 20mm

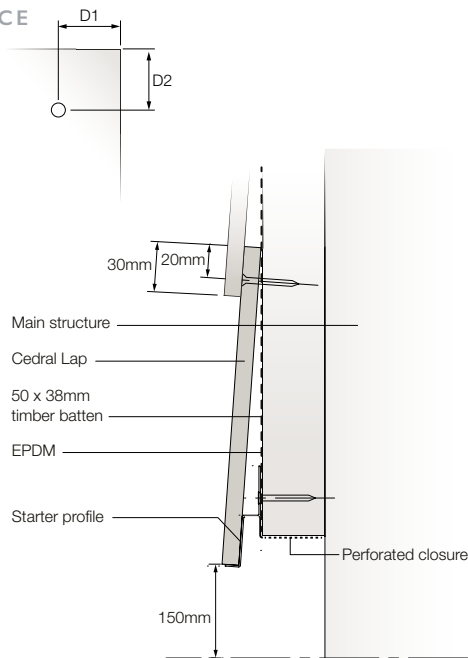

CEDRAL INSTALLATION

Overlap the next plank by 30mm, fix into place then continue fixing Cedral up the wall using the same method.

Each plank must be fixed at least once to every support. The end of every plank must also coincide with a support.

Fixing is done through the upper edges. There is no side overlap, the planks being simply loose butt jointed against one another, and the joint must coincide with a timber support.

A strip of EPDM should be applied along the length of the batten behind all vertical profiles and behind every Cedral plank joint.

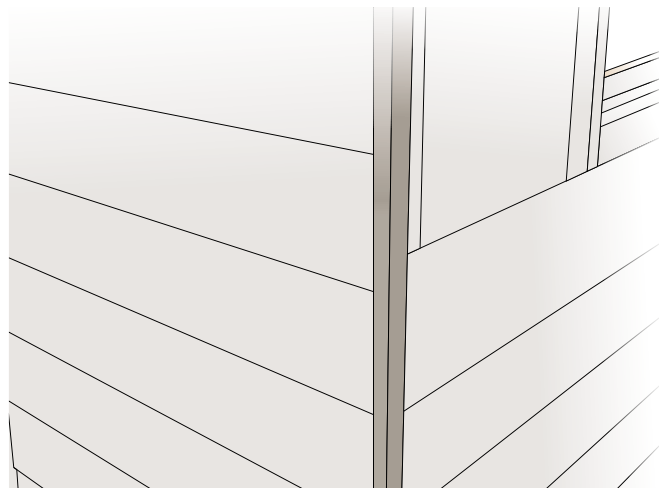

JOINTING OF CEDRAL

When two planks of Cedral are joined together, a protective strip should be placed onto the batten to guard against moisture ingress. This is known as an EPDM strip.

Planks should be loose butt jointed together, do not use force.

If movement joints are present in the structure, they must be replicated in the Cedral cladding. EPDM must be used on battens at movement joints.



FINISHING CEDRAL AT TOP OF WALL

When finishing the top plank, the fixings will remain visible. For best results use colour matched Cedral screws.

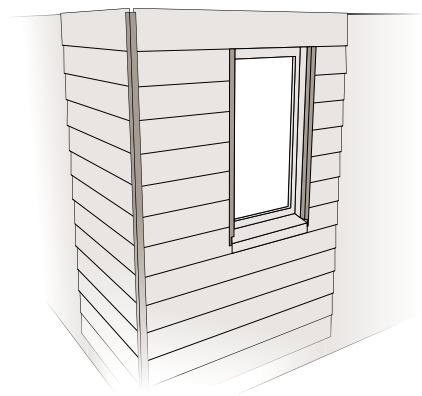

SOFFIT DETAIL

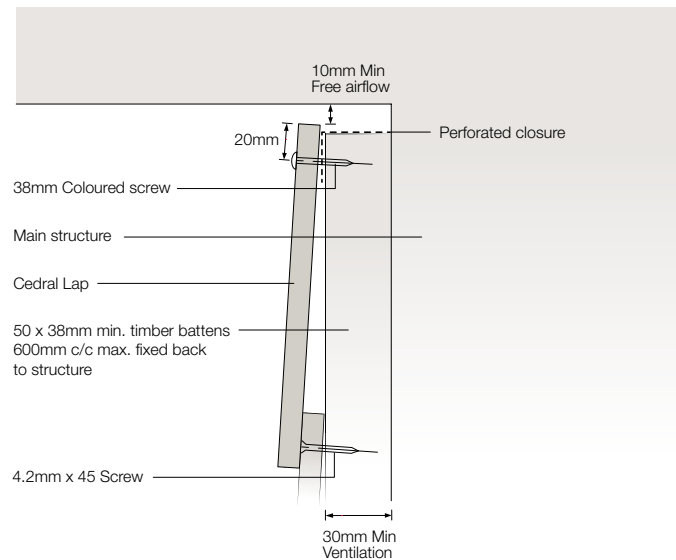

SLOPING SOFFIT DETAIL

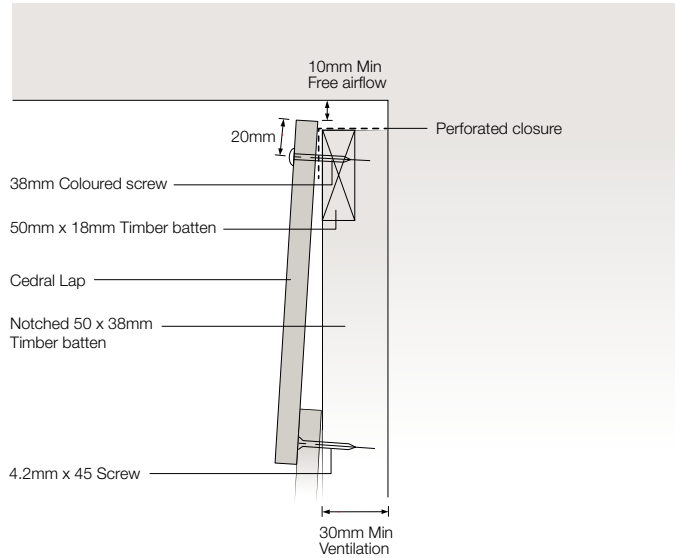

FINISHING CEDRAL AT TOP OF WALL: ABUTMENTS AND GABLES

Where Cedral abuts another material and when no end trims are required, the end of Cedral must not be more than 100mm past the last fixing point.

On the gable ends with the triangular abutment, Cedral needs to be fixed top and bottom to the batten that is parallel to the roof slope. If the bottom edge is not secured, curling can occur in certain conditions.

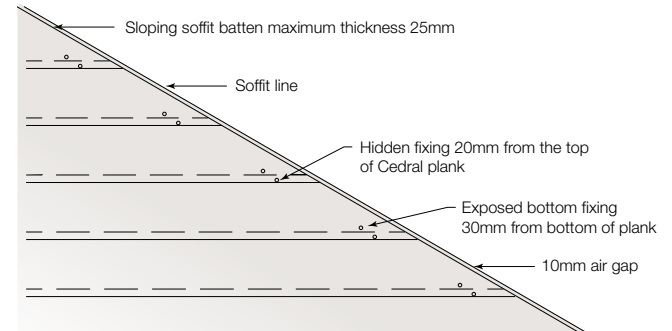

Corner options

There are a number of ways of finishing both external and internal corners using Cedral.

OVERLAPPING CORNER

This is when the board of one side overlaps the end of the plank on the other side. There will always be one end of plank showing with this method. These ends need to be decorated to match the finish on Cedral. The transverse cuts of the plank at the corner positions will not be perpendicular with the sides of the boards.

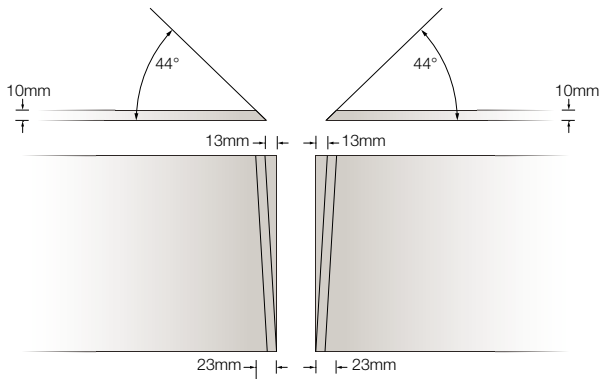

MITRED CORNER

To form the mitre the planks have to be cut 23mm longer on the bottom edge, 13mm longer on the top edge than the dimension to the corner of the support battens. This cut is also cut at an angle of 44° through the thickness of the plank (we suggest marking the plank at 45° and under-cut). The above only works on a true 90° corner, other corner angles will be by trial and error.

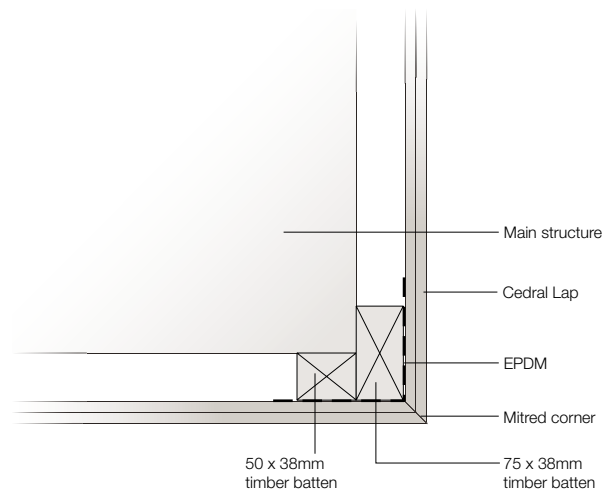

EXTERNAL CORNER DETAIL

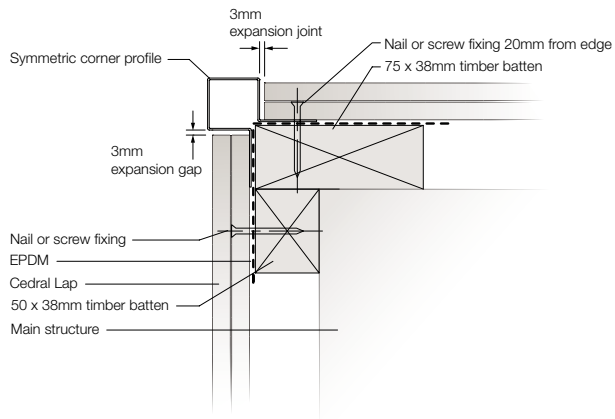

INTERNAL CORNER DETAIL

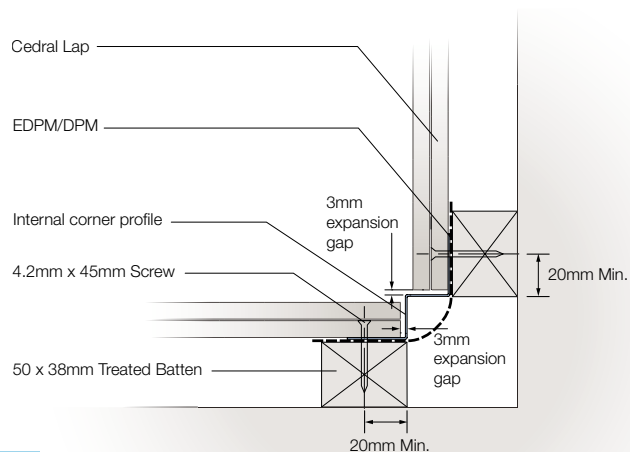

CORNER/ABUTMENT WITH END PROFILE

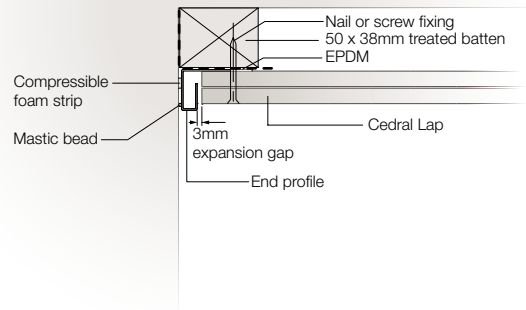

Finishing & decoration

Touch up paint is available in all colours of Cedral. This should only be used on cut edges, or for very small artificial scratches on the front face of the planks, applied sparingly using something like a small artists brush. Any overspill on the front face should be wiped away immediately with a clean and dry cloth.

Additional insulation

Should insulation be required, additional cavity depth can be gained with the use of cross battens or adjustable brackets.

SECURELY FIX HORIZONTAL BATTENS ON WALL/SUBSTRATE*

These will accommodate any insulation required and also support the vertical battens to which the Cedral planks will be fixed.

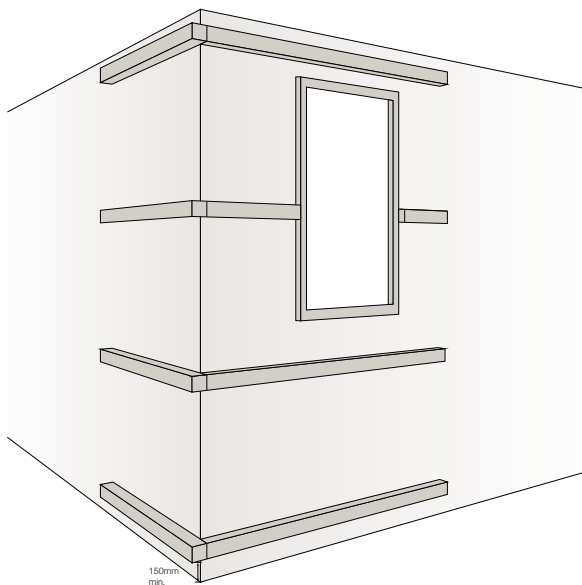

* For solid walls, timber frame and metal stud constructions it is good practice to include a breathable membrane behind the battens. Generally for unfilled/partially filled cavity walls there is no requirement to do this.

FIX INSULATION TO THE WALL BETWEEN THE BATTENS OR ANGLE BRACKETS

Make sure there are no gaps. Alternatively, use adjustable wall brackets to fix battens if greater thickness of insulation is required. Vertical battens will then be fitted on top of the horizontal battens.

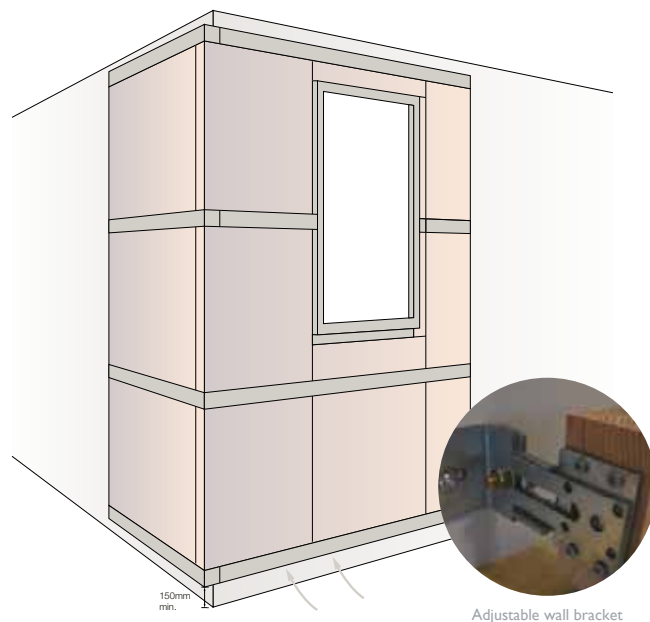

Installing Cedral Click Horizontally

- 45 Introduction
- 46 Batten fixing
- 47 Perforated closures
- 48 Vertical profiles
- 49 Horizontal profiles
- 50 Fixing method

Introduction

5 STEP INSTALLATION PROCEDURE

- 1 Fix battens to wall
- 2 Attach perforated closures to top and bottom of battens
- 3 Fix vertical profiles and horizontal starter profiles
- 4 Cut and fix Cedral planks
- 5 Other detailing



Batten fixing

If a breathable membrane is being installed, this should be behind the battens* for the Cedral. Position and fix the vertical battens. Battens to be spaced a maximum of 600mm apart (reduce this in high windload areas).

BATTEN SIZES

- Standard fixing – 75mm x 38mm
- Joints/Corners – 100mm x 38mm

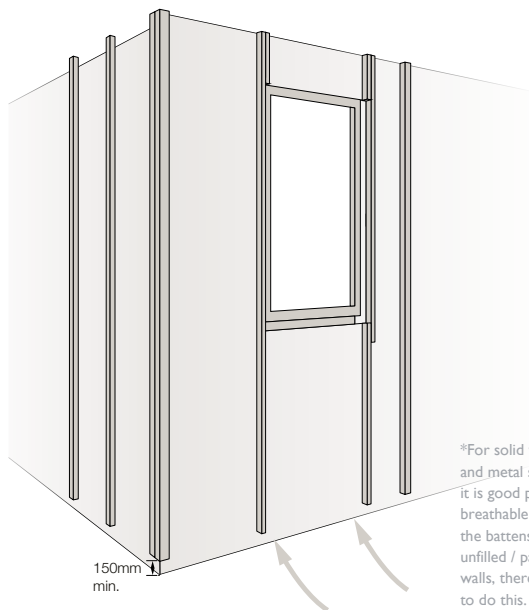

*For solid walls, timber frame and metal stud constructions, it is good practice to include a breathable membrane behind the battens. Generally for unfilled / partially filled cavity walls, there is no requirement to do this.

Perforated closures

Perforated closures should be screwed or nailed to the top and bottom at the cills and window/door heads, and at the top and bottom of the facade.

They are designed to protect against birds, rodents and some insects while still allowing air to flow through the system.

Allow 10mm continuous air gaps at the bottom and top of the facade, above and below windows and above doors. At least 25mm of the closure should be left open to the air, for example at window / door heads.

Available in depths of 40mm, 50mm, 70mm and 100mm to allow for coverage of external insulation.

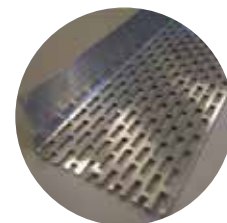
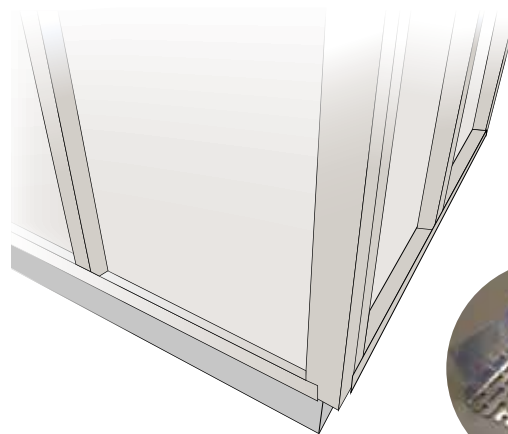

Perforated closure

Fix vertical profiles

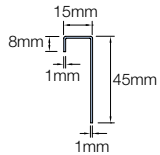

CONNECTION PROFILE

End trim to finish Cedral when used as a single piece on a window/door reveal, head reveal, and to finish cladding ends.

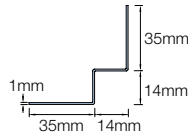

INTERNAL CORNER

To finish the corner where Cedral meets on an internal corner forming a seal between the trim and the corner.

Fix horizontal profiles

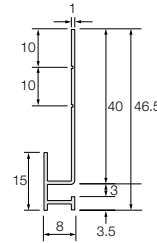

STARTER PROFILE

Used at base of the external wall. Installed absolutely level to ensure installation of Cedral Click panels remains perfectly parallel. Supplied in a mill finish.

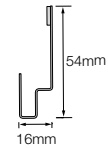

WINDOW LINTEL PROFILE

Used to finish above the window and to support the next course of Cedral Click.

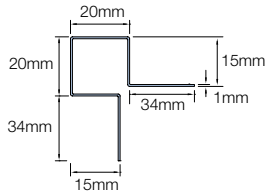

EXTERNAL CORNER/ WINDOW REVEAL

Can be used as an external corner or where detailing on a window reveal.

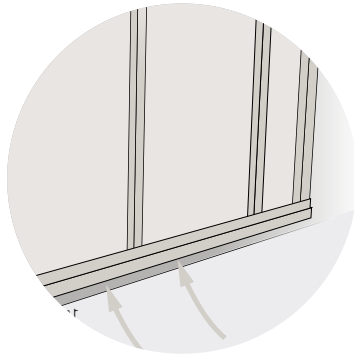

Fixing method

The majority of fixings will be achieved with Click clips.

These are fixed with stainless steel Cedral supplied, flat-head screws onto timber or with rivets onto metal framing.

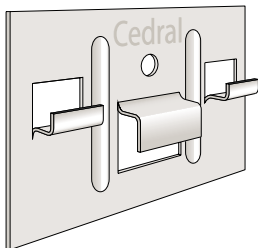

FIXING CLIP AND SPECIAL SCREW FIXING

Clip and screw (3.9 x 30mm, 11mm head) are made of stainless steel 304 (A2).

The clip dimensions are: 60 x 37 x 0.6mm with hooks matched to the Cedral Click requirements.

The screw should be the Cedral supplied fixing, as this screw has a specially designed low profile (flat) head.



BASE OF CLADDING

A minimum 30mm clear cavity must be provided behind the Cedral Click planks with a 10mm continuous air gap at the bottom and top of the facade, above and below windows and above doors. Assembly starts at the bottom of the outside wall with the purpose designed Cedral Click plank start profile. Before any Cedral profiles or planks are installed, ensure that EPDM is installed onto every batten. The start profile must be perfectly level. Use appropriate countersunk head screws so the screw head does not block the placement of the first Cedral Click plank. The first Cedral Click plank is then fitted onto the start profile and fixed with clips on every support. Then the next Cedral Click plank is put on the first one.

The plank will then be fixed with the use of Click clips, these will be placed on every batten.

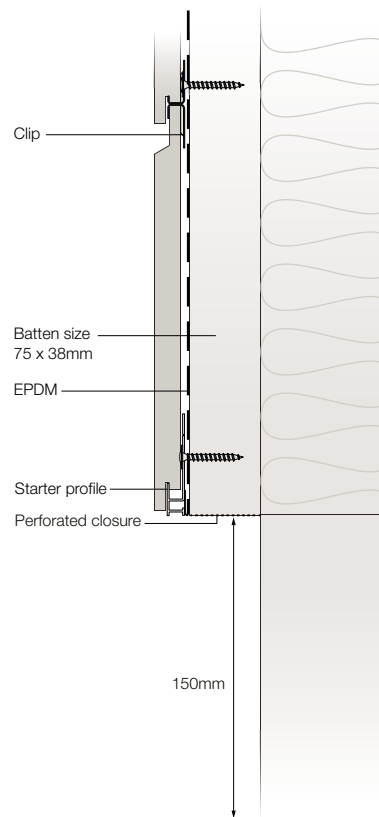



CONTINUED INSTALLATION

The Cedral Click planks are placed with the ends against each other and always on top of an underlying supporting batten.

EPDM is required on all battens for Cedral Click installations, not just behind the joints. If the joint sealing strip is exposed to light, a UV-resistant material such as EPDM must be used.

Any movement joints within the structure should also be replicated within the cladding.

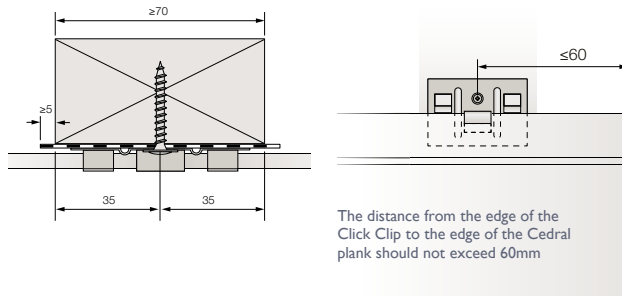

WINDOW DETAILING AND EXTERNAL CORNER

The vertical reveal sides of a window can be finished with the Cedral Click external corner profile. At the window head, the lintel profile can be used. This lintel profile can be used with whole Cedral Click planks or with cut planks. Holes in the lower part of the back of the profile prevent water pooling in the profile.

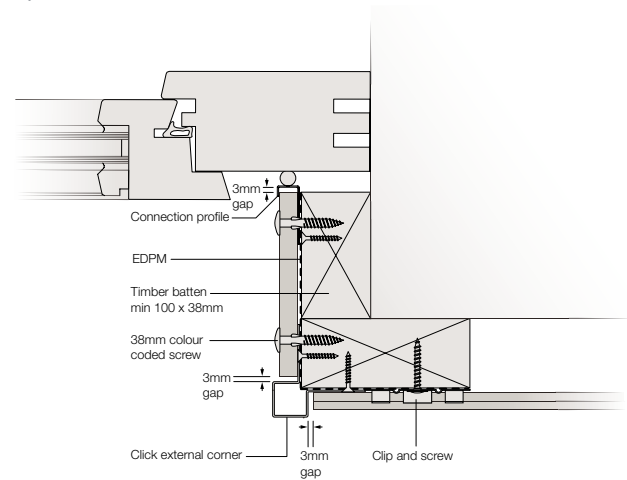

INTERNAL CORNER

To finish an internal corner, use Cedral Click internal corner profile which forms a seal between the trim and the corner.

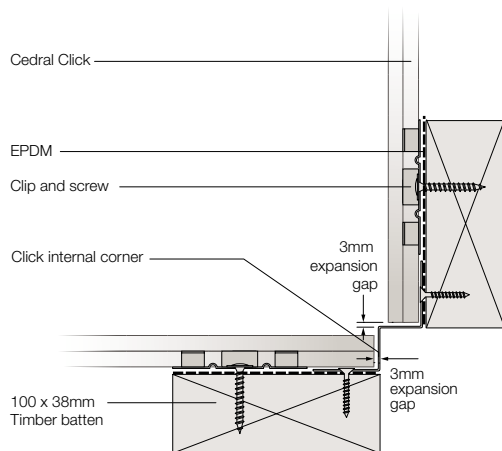

FIXING THE LAST CEDRAL CLICK PLANK

At the top of the facade there are two options for fixing the last Cedral Click plank:

- If the facade finishes with a whole Cedral Click plank it can be fixed with clips.
- If the facade finishes requiring a trimmed Cedral Click plank it should be fixed with coloured mushroom head screws.

The screws must be inserted perpendicular to the panel surface using an electric drill with a high quality bit suitable for the type of screw head.

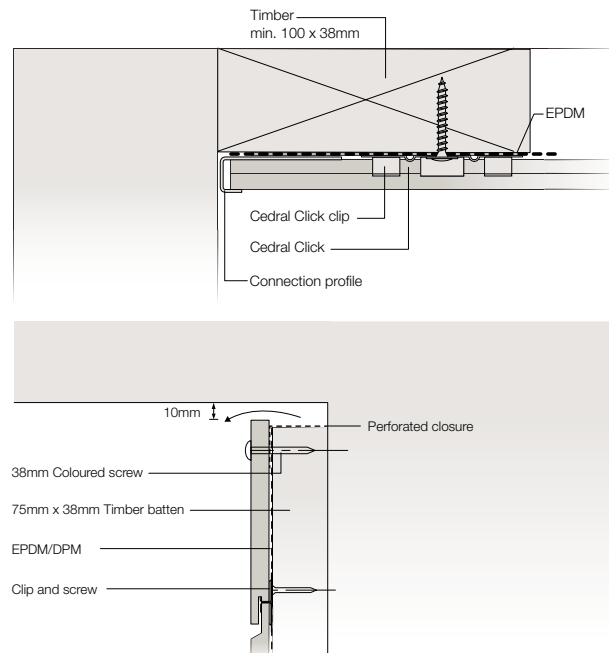

Vertical installation of Cedral

- 57 Introduction
- 58 Lay of planks
- 60 Install timber battens
- 61 Perforated closures
- 62 Cedral Lap profiles
- 64 Cedral Click profiles
- 65 Undulating Lay pattern
- 67 Flat lay pattern
- 69 Lapped lay pattern
- 71 Open Joint fixing
- 77 Cedral Click system



Introduction

VENTILATED RAINSCREEN SYSTEM

A ventilated rainscreen cladding system must be fixed onto battens to allow an air gap behind the cladding.

With a traditional horizontal installation of Cedral only vertical battens would be needed.

To install Cedral vertically, vertical counter battens must be installed first, with horizontal battens then placed on top. This allows the air gap behind the cladding while giving a fixing point. The horizontal battens can be trapezoidal in shape to aid water run off, however this is not essential. If a breathable membrane is being installed, this should be behind the vertical counter battens for the Cedral.

Please note: A minimum air gap of 10mm must be left at the top and bottom of all sections to allow air to flow completely through the system.

HORIZONTAL

Passage of air

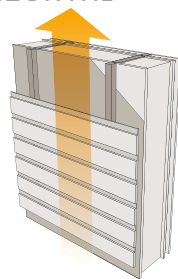

VERTICAL

Passage of air

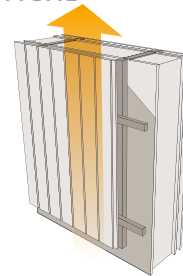

5 STEP INSTALLATION PROCEDURE

- 1 Decide on the 'lay' of the Cedral planks
- 2 Install timber battens
- 3 Fix perforated closures
- 4 Fix profiles
- 5 Install Cedral planks

Decide on the lay of the planks

Cedral can be installed vertically using one of 5 different options:

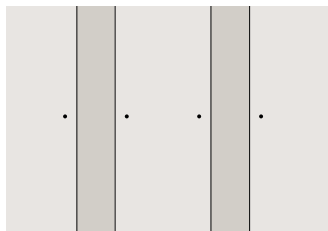

UNDULATING

Planks are laid in an “under and over” pattern. The fixings remain visible.

Page 65

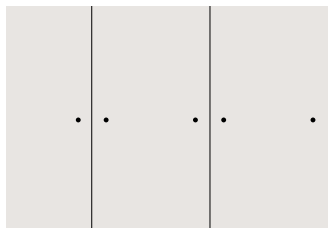

FLAT

Planks are laid next to each other, either loosely butted or with up to a 2mm gap. Fixings remain visible.

Page 67

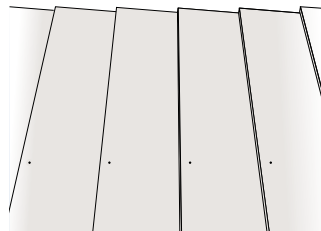

LAPPED

Planks are overlapped by 40mm. Fixings will remain visible.

Page 69



OPEN JOINT FIXING

Planks are laid with 3-12mm gaps between each plank.

Page 71

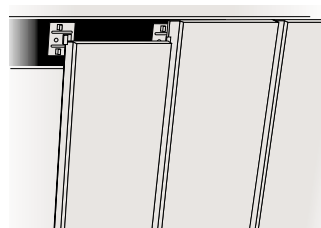

CEDRAL CLICK

Cedral Click planks are used in conjunction with Click Clips. This is a tongue and groove system where all fixings are hidden apart from the fixings on the starter and final boards.

Page 77

Install timber battens

Vertical counter battens must be placed first. These must be a minimum size of 50mm wide x 25mm deep and spaced at a maximum 600mm.

Adjustable wall brackets can be used instead of vertical timber battens.

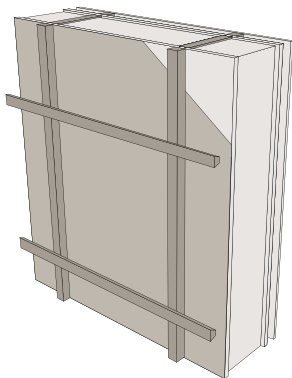
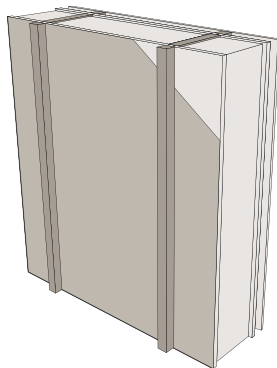

Horizontal battens should then be fixed.

These must be a minimum size of 50mm wide x 38mm deep (75mm wide x 38mm deep for Cedral Click) and spaced at a maximum 600mm.

A small gap of 5 mm should be left between the batten ends where they join.

EPDM should be installed on the front face of the horizontal battens.

Any movement joints in the structure must also be replicated on the Cedral facade.

Perforated closures

Fix perforated closures to the top and bottom of the vertical timber battens, at the top and bottom of the facade, above and below windows and above doors.

Perforated closures allow the flow of air while preventing birds, vermin or pests gaining access.

If using adjustable wall brackets, fix the perforated closure to the rear of the top and bottom vertical battens. Adjust the brackets to ensure the rear gap is completely closed top and bottom.

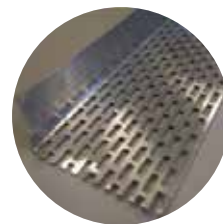

Perforated closure



Cedral Lap profiles

When installing Cedral Lap vertically*, consideration should be given to the profiles used. All profiles are supplied in 3m lengths. For further information, please contact the Facade Technical Advisory Service.

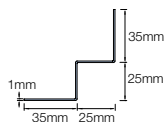

INTERNAL CORNER

To finish the corner where Cedral meets an internal corner forming a seal between the trim and the corner.

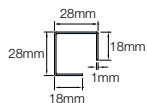

EXTERNAL CORNER JUNCTION

Used as a corner joining piece. Only available in black. 300mm length.

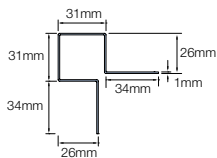

EXTERNAL CORNER (SYMMETRIC)

The profile can be installed where two elevations of Cedral join at a 90° corner.

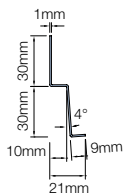

STARTER PROFILE

Installed vertically up one side to start a cladding run, for lapped lay pattern only.

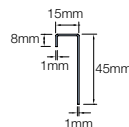

CONNECTION PROFILE

Used to finish Cedral when installed as a single piece in a window or door reveal.

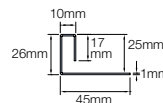

END PROFILE

To finish Cedral where installed in a lap or undulating configuration.

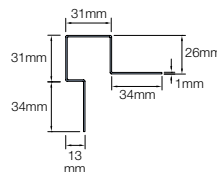

EXTERNAL CORNER/WINDOW REVEAL (ASYMMETRIC)

Used as an external corner on windows and doors when detailing a single piece in the reveal.

* For flat Lap installations, use Cedral Click external and internal corner trims instead. Change any End profiles required into Connection profiles.

Cedral Click profiles

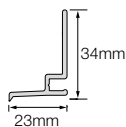

VERTICAL START PROFILE (WATERNOSE)

Used to start a vertical cladding run. Installed absolutely level to ensure installation of Cedral remains perfectly vertical. Supplied in a mill finish.

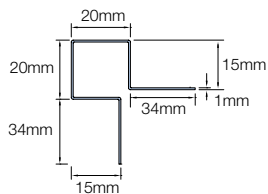

EXTERNAL CORNER/ WINDOW REVEAL

Can be used as an external corner or where detailing on a window reveal.

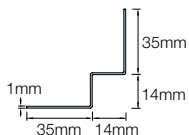

INTERNAL CORNER

To finish internal corners.

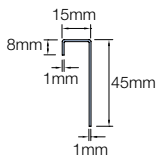

CONNECTION PROFILE

End trim to finish Cedral Click when used as a single piece on a window reveal or soffit.

Undulating lay pattern

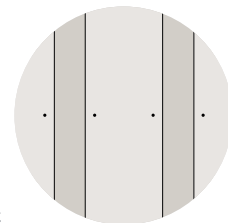

PROFILES

(Cedral Lap only, EDPM must be used on the front face of all horizontal battens)

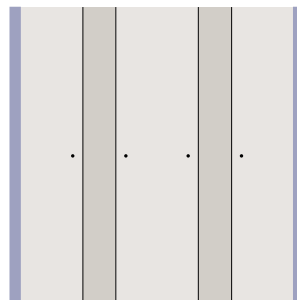

Fix vertical symmetric external corner profiles, asymmetric corner profiles, internal corner profiles or end profiles depending on the application.

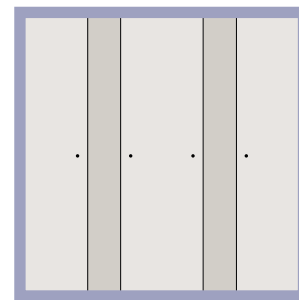

Fix end profiles horizontally at the top and bottom of each run of planks. Drill weep holes every 300-400mm in the end profiles to allow for drainage.

Install perforated closures to the top and bottom of battens.

Please note profiles must be fixed before any Cedral planks are laid.

FIXING METHOD

Begin by placing all rear planks and spacing with a 70mm gap between each plank. Fix into place using Cedral 4mm x 45mm stainless steel countersunk screws, twice onto every batten every 600mm a minimum of 20mm from the edge of the plank.

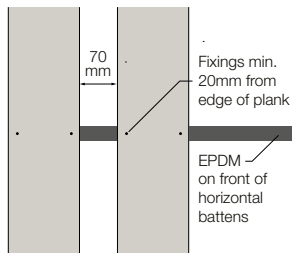

Place front planks over the rear plank ensuring the overlap is a minimum of 60mm.

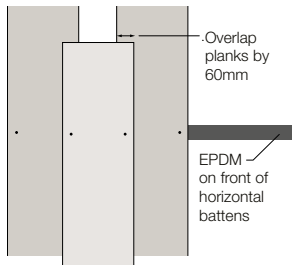

Screw through the face of the front planks penetrating both planks and screwing into the timber, using longer length colour coded screws. Fixings must be 20mm minimum from the edge of the plank and again all planks must be fixed twice to every batten.

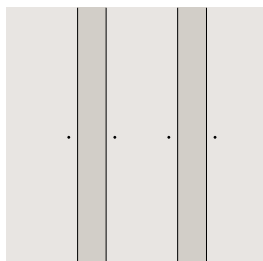

Flat lay pattern

PROFILES

(Cedral Lap only, EPDM must be used on the front face of all horizontal and vertical battens).

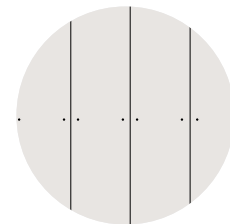

Fix vertical connection profiles and Click external and Click internal corner profiles

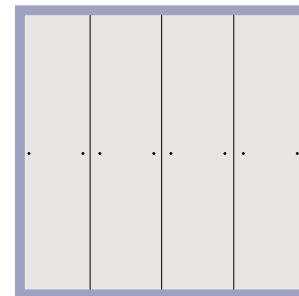

Fix connection profiles to the top and bottom of each section of planks. Drill weep holes every 300-400mm in the connection profiles to allow for drainage.

Install perforated closures to the top and bottom of battens.

Please note profiles must be fixed before any Cedral planks are laid.

FIXING METHOD

Place the first plank then screw into place, using Cedral 38mm colour coded screws. Ensure fixings are a minimum of 20mm from the edge of the plank and the plank is fixed twice onto every batten.

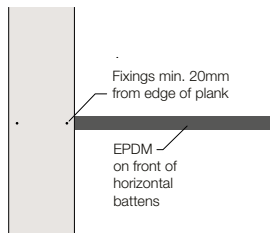

Loosely butt joint the next plank or leave a uniform gap of between 0 and 2mm between planks. Screw into place in the same way.

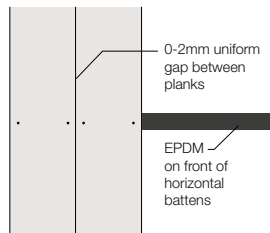

Continue to place planks and fix into place.

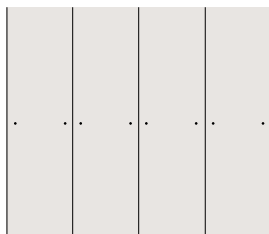

Please note profiles must be fixed before any Cedral planks are laid.

Lapped lay pattern

PROFILES

(Cedral Lap only, EPDM must be used on the front face of all horizontal battens)

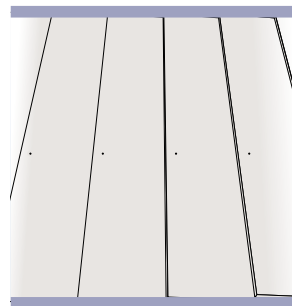
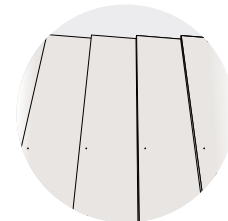

Install horizontal end profiles at the top and bottom of each section of cedral planks. Drill weep holes every 300-400mm in the end profiles to allow for drainage.

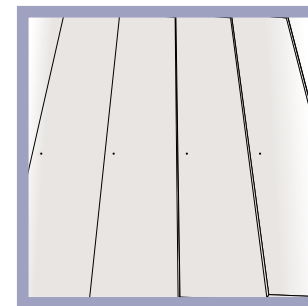

Fix vertical symmetric external corner profiles, asymmetric corner profiles, internal corner profiles or end profiles depending on the application.

Fix starter profiles where required to kick the first board of each run out to make it uniform with the rest.

FIXING METHOD

Place the first plank onto the start profile, timber fillet or tilt to give a 10mm “kick out”, then fix into place using longer length colour coded screws, ensuring fixings are 20mm from the top edge of the plank.

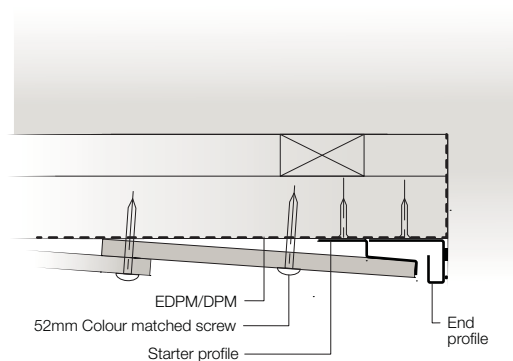

Place secondary fixings through the tail of the plank at 50mm from the edge and fixings are every 600mm (these will remain visible).

Overlap 40mm with the next plank then screw into place through both the head and the overlap to reduce water ingress.

Continue lapping and fixing planks into place until complete.

Open joint fixing



Planks are laid next to each other, with a 3-12mm open gap between each.

The maximum allowed height for Cedral Lap vertical with gap lay pattern is 10m.

Note that this system of vertical open-jointed rainscreen allows more water to enter the cavity space.

The watertightness of the structure behind the planks must be robust enough to prevent water causing damage to the structure.

Protection can be provided by a breathable, water tight membrane installed directly behind the vertical timber battens. Ensure the insulation used is suitable for this type of open-jointed facade.

Gaps wider than 12mm should always be baffled.

VENTILATION AND DRAINAGE

Although open gaps will have a positive influence on the ventilation, the stack-effect is relied on to achieve necessary ventilation levels.

Because of the open gaps, a significant amount of rainwater will enter the cavity and openings at the bottom of the cavity are needed to evacuate the infiltrated water.

Cavity width

The minimum cavity width air space should be 50mm directly behind the panel when gaps are closed/baffled and 75mm when gaps are left open.

Deeper battens will be required to achieve the deeper cavity.

Allow for a tolerance of 20mm when designing a cavity.

Insulation

Insulation should be protected with a UV-stable breather membrane, preferably black in colour.

The flexible rainproof, breathable membrane should meet EN 13859-2 and have increased UV stability in case of (partial) direct exposure behind open gaps.

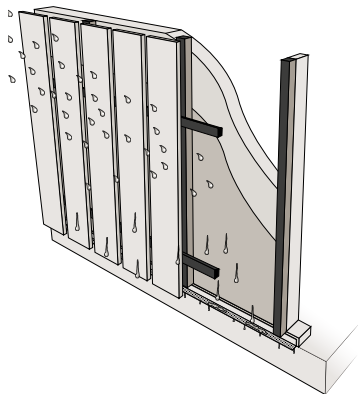
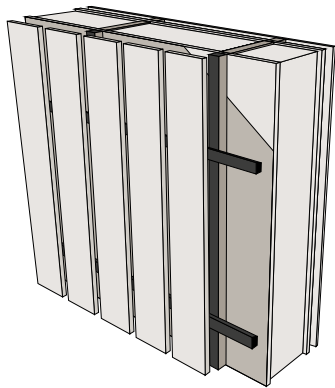

BATTEN SIZES

Horizontal battens must be a minimum size of 60mm wide x 38mm deep and trapezoidal in shape. Although a minimum width of 60 mm is recommended, a larger batten width would allow tolerance for adjustment.

All horizontal battens should be protected on the front face and top edge by a UV resistant joint sealing strip or EPDM.

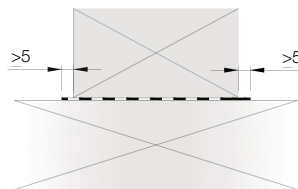
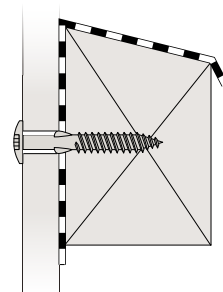
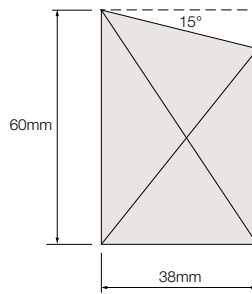

The vertical counterbattens should also be protected on the front face by EPDM. The EPDM should cover the batten completely and overhang both edges by a minimum of 5mm.

Make sure cut ends of EPDM overlap at least 10cm where ends meet.

FIXING CENTRES AND EDGE DISTANCE

As for other laying options, Cedral Lap planks for gap fixing are visibly fixed with Cedral 38mm colour coded screws.

Ensure fixings are a minimum of 20mm and a maximum of 40mm from the long edge of the plank.

Edge distance from the short edge should be between 40 and 100mm.

The centres for the rest of the fixings are determined by the designer's wind load calculations.

Fixings must be within the darker shaded area

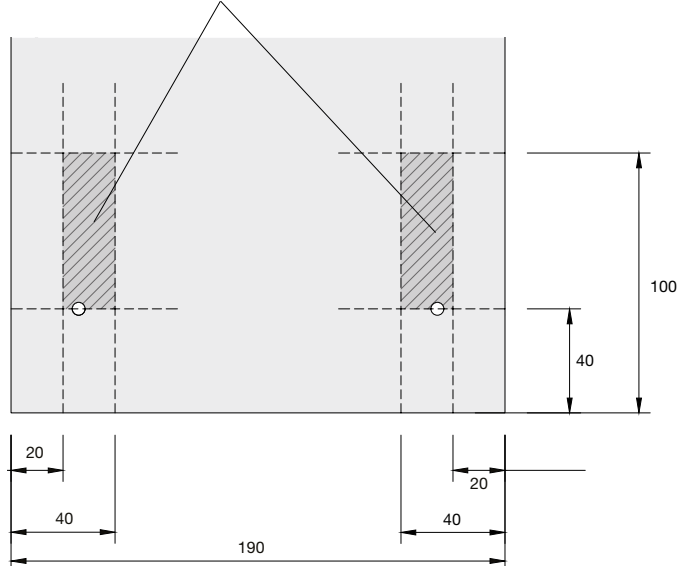

FIXING OF TRIMMED PLANKS

Maximum width for 1 x fixing = 80 mm, edge distance between 20 and 40 mm.

Minimum width for 2 x fixings = 80 mm, edge distance between 20 and 40 mm, intermediate distance more than 40 mm.

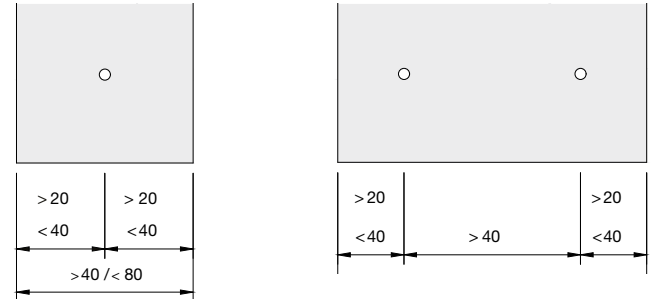

FIXING OPTIONS

Planks are fixed twice centred to each horizontal batten with Cedral colour matched screws (see page 84). The screw head should lie flat on the surface.



Fixed twice using Cedral colour matched screws

FIXINGS AT BUTT JOINTS

Normally, in the gap laying pattern, Cedral Lap is installed with a 5mm gap between butt jointed planks. Both panel ends should be fixed on an underlying batten at a 40mm distance from the butt end edge.

This can be achieved by fixing two additional horizontal battens, one behind each panel end.

Alternatively, one larger batten can be used, instead of 2 separate battens.

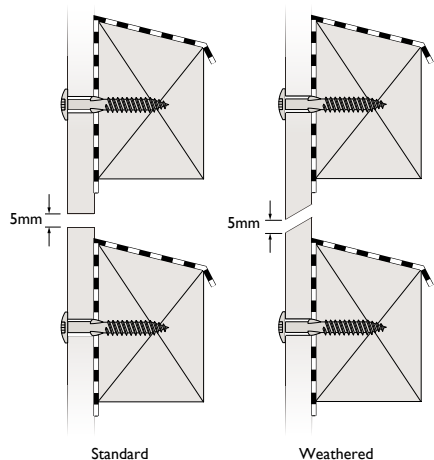
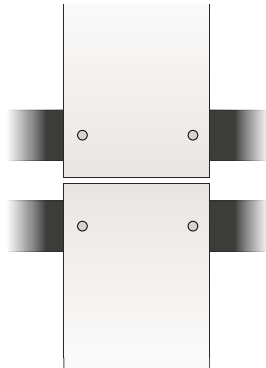

TYPES OF BUTT JOINTS

A butt joint should be 5mm. The shape of the butt joint is influenced by the driving rain index. Both standard open joints and weathered joint (with angled board edges) are possible.

If using the Cedral Click system

EDPM must be used on the front face of all horizontal battens.

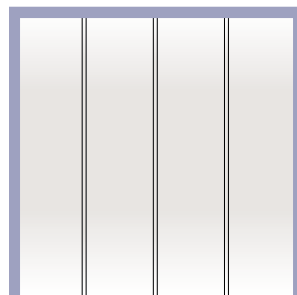
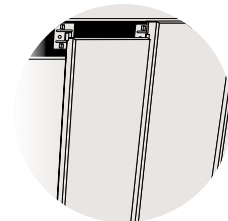

Install external corner, connection and/or internal corner profiles depending on the application.

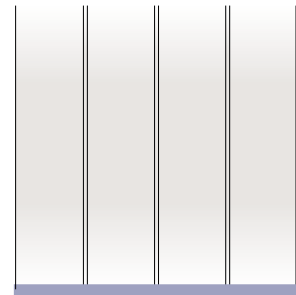

Fix vertical start profile below all Cedral Click planks to support the system. Vertical start profiles are required at every 3.6m for every row of new planks.

Colour coded screws can be used instead of an additional start profile, please contact the Cedral Technical department for further information.

Slot the first plank into the starter profile.

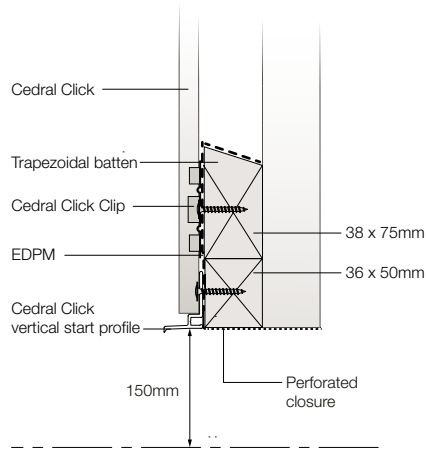

Rest the bottom of the planks on the vertical start profile. Please note the bottom batten must be trimmed to allow this to fit correctly as per the diagram above. This must also be repeated between joints.

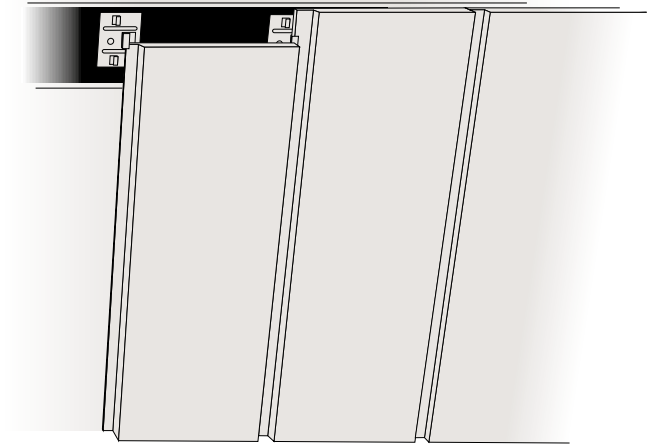

The first plank will be fixed with Cedral 38mm colour coded screws up one edge, then also with the Clips on the battens at the other edge up the plank. An alternative to the colour coded screws on the first plank is to use the standard Click Start profile normally used for horizontal installations, please contact Technical for further information

Slot the next plank into the clips that were just fixed. Rest on the vertical start profile and place clips onto this new plank and fix into place. Continue until complete.

On installing the final plank, the fixings will be visible. Cedral 38mm colour coded screws are again used for this.

Soffits and fascias

- 81 Introduction
- 82 Fixing method



Introduction

CEDRAL BOARD

Cedral board helps you to create an attractive, consistent look down to the very last detail. They can be used to cover roof edges, reveals and other facade elements to match or contrast your facade.

- 2500mm x 200mm x 9mm
- 2500mm x 300mm x 9mm
- 2500mm x 400mm x 9mm
- 2500mm x 1220mm x 9mm
- 3050mm x 1220mm x 9mm

It can be used for soffits and fascias if attached to aligned supporting battens. Ventilation is assured by using:

- 1 Vertical supporting battens, 50mm wide x 38mm deep (increasing to 100mm wide for joints and corners).
- 2 Horizontal supporting battens 50mm wide x 38mm deep combined with ventilation blocks or ventilation battens.

EXAMPLE 1

Soffit and fascia at typical gable end attached with screws on ventilation blocks.

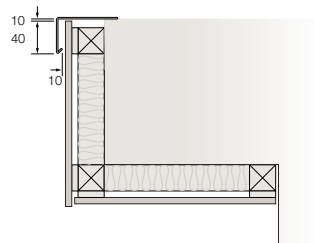

EXAMPLE 2

Attachment on vertical supporting battens. The vertical battens must be thick enough to withstand wind pressure.

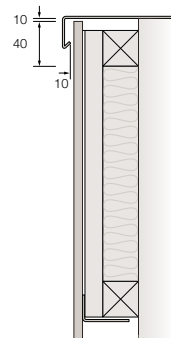

For fascias or soffits higher / deeper than 400mm, please contact the Technical department for further advice

Fixing method

Cedral Board can be screw fixed. As a general rule, the following maximum distances between the fixing accessories must be maintained.

MAXIMUM FIXING DISTANCE (SCREWED)		
	Land 0-20m	Coast 0-20m
MULTIPLE SPAN		
Edge area facade soffit	400mm	400mm
Bottom of soffit	400mm	400mm
SINGLE SPAN		
Edge area facade soffit	400mm	400mm
Bottom of soffit	400mm	400mm

VISIBLE FIXING USING SCREWS

Cedral Boards can be fixed by means of a stainless steel (quality A2, AISI 304) panel screw with coloured TORX T20 recessed head to the wooden supporting battens.

Screws are inserted using an electric drill with a high quality bit suitable for the type of screw head.

Screws must be inserted perpendicular to the panel surface, and may not be over-tightened so that the free expansion of the panel is not impeded.

This is achieved by limiting the moment setting of the drill

- 1 Minimum screw depth in supporting battens: 23 mm
- 2 Minimum distance from screw edge in supporting battens: 15 mm

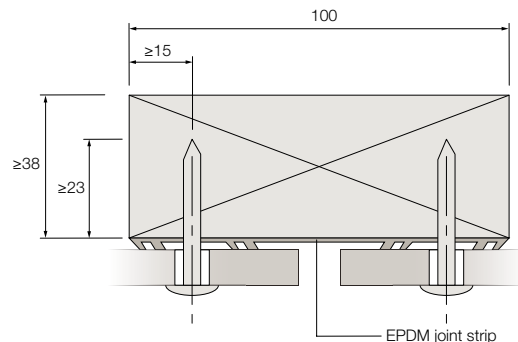

EDGE DISTANCES

The following minimum and maximum distances from the edges of the fastening accessories must be respected. Drilling the holes can be done using a template.

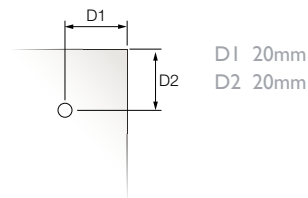

COLOUR CODED SCREW TYPE

The Cedral screw should be used. The screw is provided with a very sharp point and wings on the shaft so the pre-drilling of the panel is not needed.

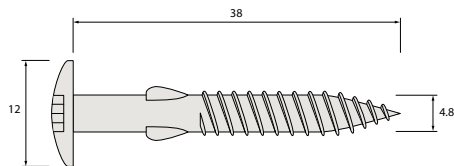

JOINT FINISHING

The Cedral Board panels are fixed with open joints to allow the free movement of the panel.

Soffits joint width: 3 mm

Waterproofing of the joint and ventilation behind the board is realised with a UV-resistant PVC ventilation block or EPDM strip.

EPDM

Ribbed EPDM dimensions: 4048581 90mm x 50m, 4035376 90mm x 10m
4048582 45mm x 100m, 4035377 45mm x 10m, flat EPDM joint strip
4023320 100mm x 20m, PE foil / joint strip, 4006466 100mm x 30m

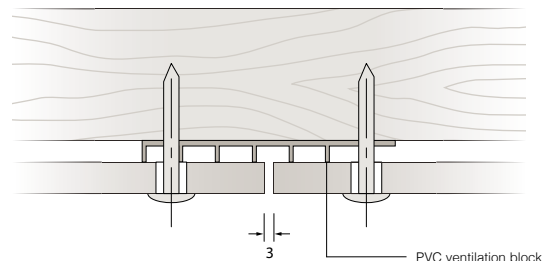
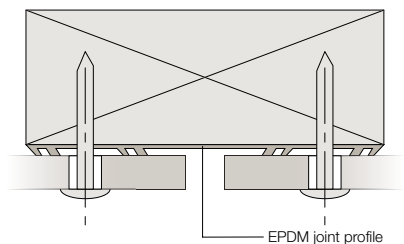

ACCESSORIES

The following accessories can be obtained from Cedral stockists.

- Ventilation block for ventilation: black pvc 69mm x 6mm x 3m
- Cedral Click connection profile and external corner
- Perforated closure when used with vertical batten
- Cedral screws: coated stainless steel 4.8 x 38 K 12 mm
- EPDM

OTHER CONSTRUCTION DETAILS

Movements in the metal sections (corner sections, bottom section, etc.) must always be isolated from the panels.

If necessary, aluminium sections must be pre-drilled, and fixed according to the principle of 'fixed and free' fastening points.

Joints between the metal sections must coincide with joints between the panels.

Finishing sections in metals that can leach (such as zinc, copper, lead, etc.) are not recommended because of possible staining.



Preventing efflorescence

Efflorescence or 'lime bloom' is an occasional phenomenon that affects all cement-based products. It is temporary and is in no way detrimental to the performance of the product. Water dissolves salts within the product, this salt solution migrates to the substrate's surface, and a salt deposit remains after the water evaporates. Efflorescence is not normally due to faulty materials.

Cement contains an amount of free lime. When water is added, a series of chemical reactions commence which result in the setting and hardening of the cement, which is accompanied by the release of more lime in the form of Calcium Hydroxide. This salt is sparingly soluble in water and the supersaturated solution deposits crystals on the surface of Cedral.

The prime cause for the onset of efflorescence is the retention of water between the Cedral planks whilst retained in the pack or its installation in very wet conditions. It is recommended that Cedral is stored under cover and clear of the ground prior to being used on site. The polythene wrapper should not be relied on for protection in the open. Care should be taken to prevent excessive moisture running down the rear face of the Cedral during installation. A ventilated cavity behind Cedral will help prevent moisture becoming trapped.

The duration of efflorescence is dependent on the quality and type of deposit and upon prevailing conditions. Water, the element that is initially responsible for its appearance, is also largely responsible for its disappearance.

Rainwater being slightly acidic not only dissolves the deposit, but also mechanically removes it by movement down Cedral. Although it is impossible to state categorically how long efflorescence will take to be removed by wind and rain; a period of suitably bad weather is usually sufficient to restore Cedral to an even appearance.

Washing with warm water and a soft brush can accelerate its removal, however care should be taken to avoid damaging the painted surface. More stubborn deposits can be removed with 9.5% acetic acid. Allow to react for a few minutes but do not allow to dry out, then wash with plenty of cold water. Repeat procedure if required. Try on a small area first to avoid damage.

For CAD details and technical support, contact:
Technical Advisory Service at techuk@etexgroup.com.
Tel: 01283 501505 Website: www.cedral.world

This publication is based on the latest data available at the time of printing. Due to product changes, improvements and other factors, the Company reserves the right to change or withdraw information contained herein without prior notice. For specific applications users should refer to the Technical Advisory Service and relevant Standards and Codes of Practice for guidance.

The photography shown in the document should not necessarily be taken as recommendations of good practice. The printing process restricts the exact representation of colours. For true colour reference, please request product samples.

CEDRAL



The world of Facades



MORE AT CEDRAL.WORLD

Etex (Exteriors) UK

Wellington Road | Burton-upon-Trent | Staffordshire | DE14 2AP

infouk@etexgroup.com | 01283 501 555

September 2023

etex inspiring ways
of living