

werzalit®

since 1923.

Newly developed process
for ultimate UV resistance.
new.

Facade systems

Facades for generations



www.werzalit.com

Since 1923.



selekta REFINE-
Dekopan - african ebony - 158





WERZALIT

What began in 1923 as a small company manufacturing glue has developed into a global brand over the decades. Inspired by the cooperation with wood processing companies, company founder Jakob Friedrich Werz came up with the idea of improving the natural material wood and making it more versatile: He pressed wood chips with glutin glue. He constantly perfected processes and recipes until he succeeded in developing a revolutionary process in the mid-1950s - and WERZALIT was born.

WERZALIT is a tried-and-tested, extremely hard-wearing composite material with a consistently uniform material structure that is also biodegradable. Its versatility, problem-free processing and durability have made WERZALIT the epitome of wood-based materials. WERZALIT combines high functionality with ecological aspects and emotions.

And has done it for over 100 years.



selekta Maximum durability

With WERZALIT selekta REFINE facade profiles with optimal design and impressive colours, you can create future-proof and flexible facades according to your individual taste.

selekta REFINE combines a system from HPL (high pressure laminate) production that has been tried and tested for decades with a newly developed production process. This combination enables innovative facade designs with the best UV- resistance, durability and the lowest maintenance costs.



WERZALIT advantages at a glance

- Extremely weather-resistant and UV-stable
- Almost maintenance-free
- Easy to work with
- Fast, economical installation
- 10-year guarantee
- PEFC-certified and 100% recyclable
- Made in Germany

The facade in strips

The selekta REFINE & selekta ALU facade profile offers almost unlimited design options. The profiles can be laid vertically, horizontally, diagonally or – by using a special clamp attachment – with the classic weatherboarding effect. And they can be combined with other facade systems.

Even more possibilities

Thanks to the large selection of colours and decorative styles, you can design your individual facade. The facade profiles stand for longevity, UV and weather resistance. The maintenance effort is low.

Easy to work with, versatile assembly.

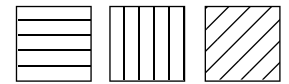

selekta REFINE -
Dekopan dark cedar - 154



selekta REFINE -
Dekopan walnut - 157

At a glance

Technology built to last

Two systems that have been tried and tested for decades have been reunited in selekta REFINE. This endless experience inspires confidence and guarantees longevity.

Fast & flexible

The fact that the facade profiles are easy to work with and can be installed on well-known substructure systems saves valuable time and money. selekta is ideal for combining with other facade systems.

Protection & the environment

selekta protects your building for the long-term. The long service life and virtually maintenance-free surface benefit both the building owner and our environment.

Sustainable

selekta REFINE is made exclusively from renewable materials.

Timelessly unique

Our finishes are timeless, and lend your building an incomparable aesthetic. In addition to the standard colours, almost all RAL shades are available on request.



Installed horizontally



Installed vertically



Installed diagonally



Weatherboarding



The WERZALIT climate facade

As a veil-like, rear-ventilated facade, selekta REFINE provides long-term protection for buildings from the effects of weather and noise. Thermal insulation and facade cladding are structurally separate from each other, with a ventilation space in between.

Moisture from construction and usage is removed and the facade is kept dry, which guarantees a long service life. Veil-like, rear-ventilated facades are suitable for a wide variety of building types, for office and commercial buildings as well as for single and multi-family houses.

Adapted to the building, selekta REFINE offers almost unlimited design options for the most modern and visually appealing facades.

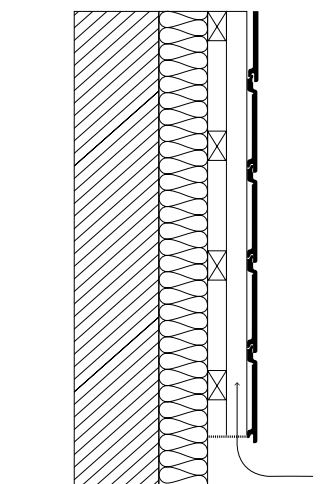



selekta REFINE -
Dekopan cedar - 082



selekta REFINE -
Dekopan meranty - 151

selekta REFINE and selekta ALU lend a special individuality and personality to building facades and exterior walls.

Different insulating materials can be used without any problems and they can be combined with other building materials such as wood, concrete or other facade systems.

Our materials

selekta REFINE is made from the WERZALIT wood-based material and consists of machined fresh wood, mainly beech and pine. The chips are inseparably pressed with the specially coated surface decor under great pressure and heat by adding resins. This results in an extremely weather and UV-resistant surface, with a large selection of decors that are suitable for the requirements of the facade.

selekta ALU is an extruded aluminum profile that can be powder-coated in a choice of 4 wood decorative styles or a virtually unlimited choice of colours. Aluminum has been a tried and tested material for facades for many decades.

square is a high-pressure laminate panel (HPL), which is pressed from craft paper soaked in resin under great heat and pressure. The square facade panels can be supplied in large formats and many different decors for large-area facades.

Permanently beautiful

With the help of innovative materials, WERZALIT offers consistently beautiful low-maintenance facades. All materials are resistant to moisture, heat, mechanical stress and insects - ideal for outdoor use.

Strong against wind and weather

WERZALIT materials pass extreme endurance tests such as swelling tests. The material is exposed to a wide range of influences and climate fluctuations between -30°C and +70°C in special climate chambers. On the WERZALIT test fields, test facades have been defying wind and weather for 30 years. WERZALIT profiles have even been tested for earthquake safety.



selekta REFINE -
Colorpan pure white - 701

Lived straightness

With selekta REFINE and selekta ALU you can design facades with individuality and personality. selekta facade profiles offer almost unlimited possibilities for this.



The advantages at a glance

- Can be laid vertically, horizontally, diagonally or in classic weatherboarding
- Large selection of colours and decorative styles
- Exceptional UV and weather resistance
- Fast and economical to work with
- Complete range of accessories
- Easy to assemble tongue and groove system
- Almost maintenance-free
- Attractive guarantee conditions

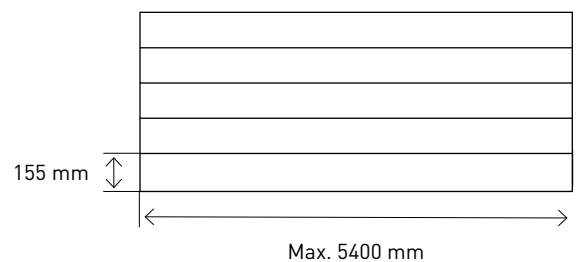



selekta REFINE -
Dekopan cedar - 082

selekta REFINE

Durable like high-pressure laminate panels (HPL)

Our selekta REFINE facade system offers maximum UV and weather resistance paired with incomparable sustainability. The individual layers are permanently pressed together during production. Easy assembly thanks to the tongue and groove system.

Raw length 5500 mm, covering area 5400 mm x 155 mm

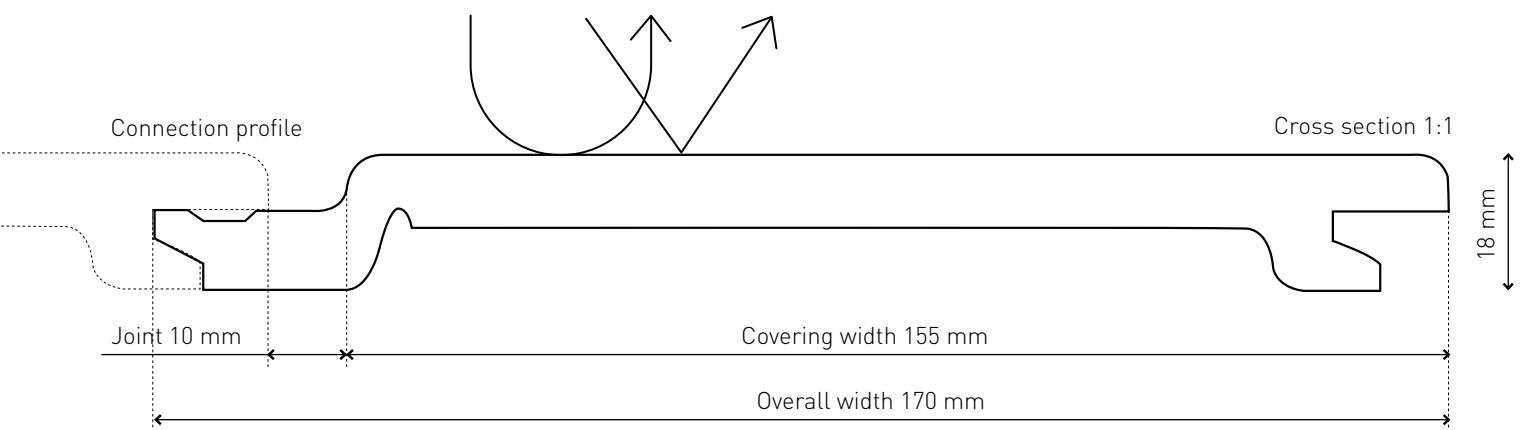

Technical data

Profile width:	170 mm
Covering width:	155 mm (+1/-2 mm)
Covering length:	max. 5400 mm
Profile thickness:	18 mm
Material:	WERZALIT
Weight:	1,50 kg/m
Surface:	selekta REFINE decorative styles with UV resistance
Fire rating:	B2 (normal flammability)
Delivery lengths:	5500 mm
Material needs:	6,45 m / m ²

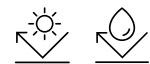

Maximum UV and weather resistance

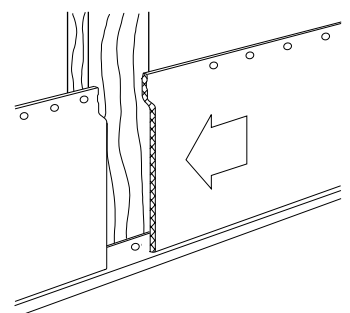

Decors and colors selekta REFINE



Dekopan
dark cedar - 154



Dekopan
meranty - 151



Dekopan
walnut - 157



Dekopan
white oak - 152



Dekopan
cedar - 082



Dekopan
birch - 156



Colorpan
pure white - 701



Colorpan
cream white - 716

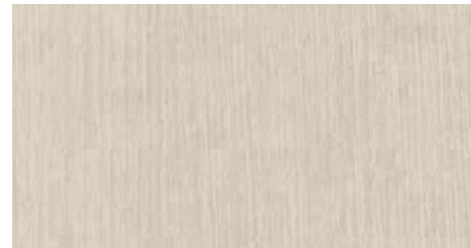

Colorpan
light grey - 718



Colorpan
dark grey - 719

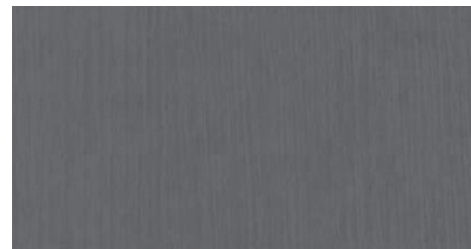

Colorpan
anthracite grey - 721

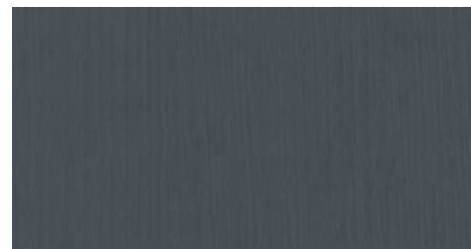

Dekopan
african ebony - 158

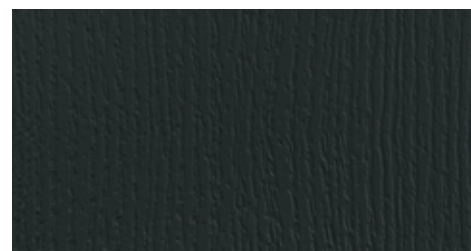

selekta ALU

Aluminum for eternity

selekta is also available as an aluminum profile. The non-combustible building material offers an alternative to our core product selekta REFINE.

Raw length 5480 mm, covering area 5400 mm x 155 mm

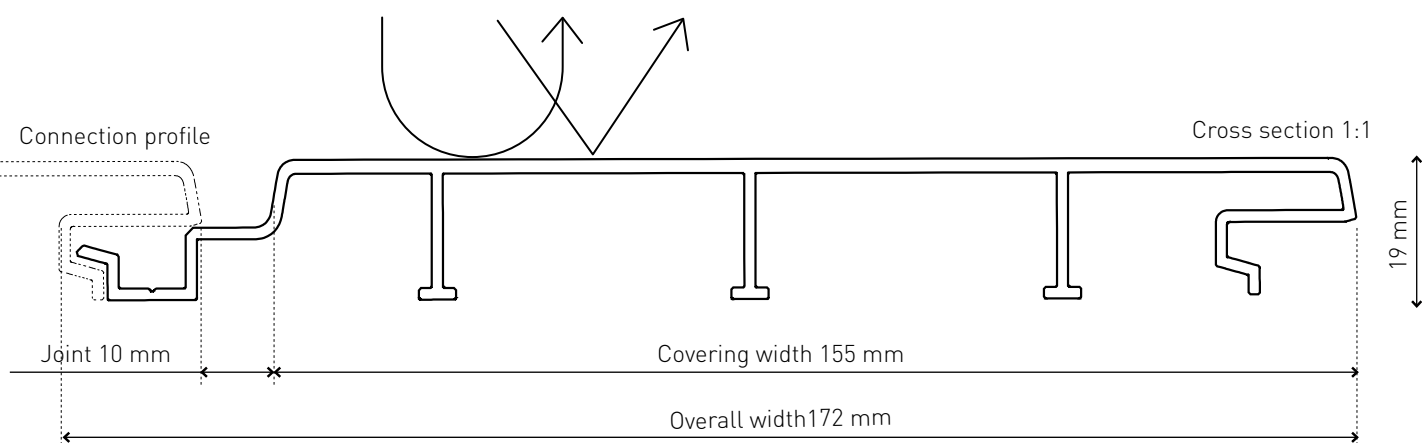

Technical data

Profile width:	172 mm
Covering width:	155 mm (+1/-2 mm)
Covering length:	max. 5440 mm
Profile thickness:	18 mm
Material:	Aluminum - AlMg2
Weight:	1,26 kg/m
Surface:	Powder coated with decor
Fire rating:	A1-s1; d0 - non-flammable
Delivery lengths:	5480 mm
Material needs:	6,45 m / m ²

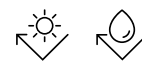

Maximum UV and weather resistance

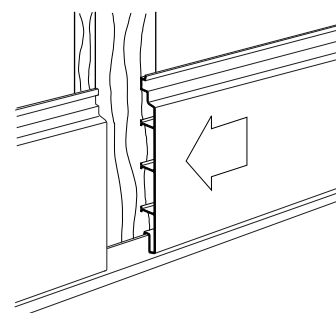



⊕ selekta ALU - mountain pine - 161

⊕ square - silver grey - 512



RAL colors on request

Decors selekta ALU



selekta Alu
Wood decors



dark cedar - 154



balau - 159



mountain pine - 161

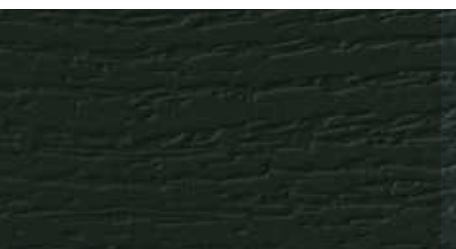

african ebony - 158



Aluminum
Parts



001
white

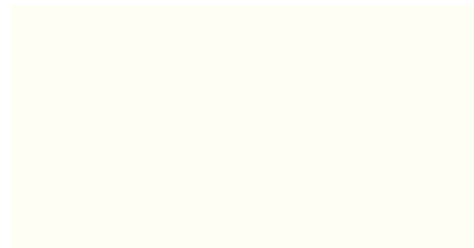

024
light anodized

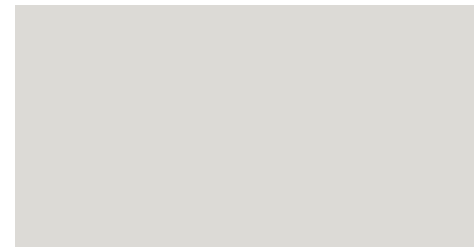

025
dark anodized

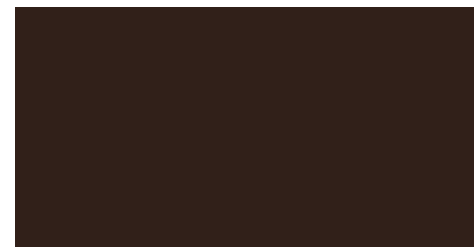

026
black anodized

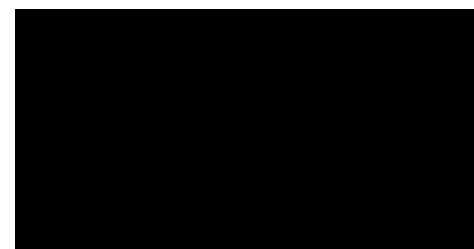

selekta Renolit

The façade profiles covered with the proven Renolit film offer the highest UV and weather resistance paired with incomparable sustainability.

Raw length 5500 mm, covering area 5400 mm x 155 mm

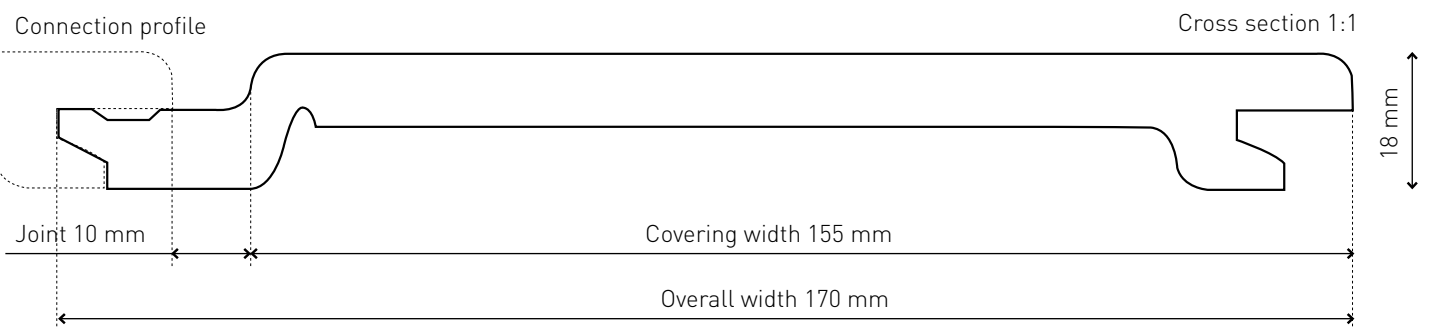

Technical data

Profile width:	170 mm
Covering width:	155 mm (+1/-2 mm)
Covering length:	max. 5400 mm
Profile thickness:	18 mm
Material:	WERZALIT
Weight:	1,50 kg/m
Surface:	Decorative film with UV protection
Fire rating:	B2 (normal flammability)
Delivery lengths:	5500 mm
Material needs:	6,45 m / m ²

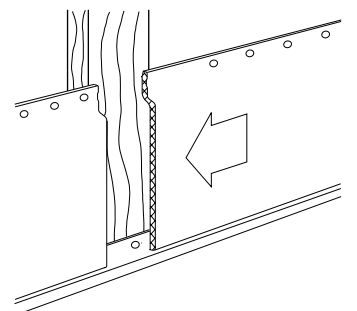

Decors et colors selekta Renolit

Complete Renolit colour pallet available on request.



829
oregon



830
natural oak



831
winchester



832
honey oak



833
soft cherry

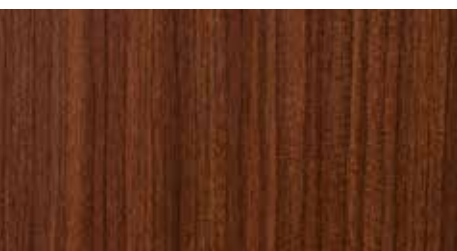

834
macore



835
weissbach oak



836
mountain oak



837
siena



838
moor oak



815
cristal white ash



816
cream white

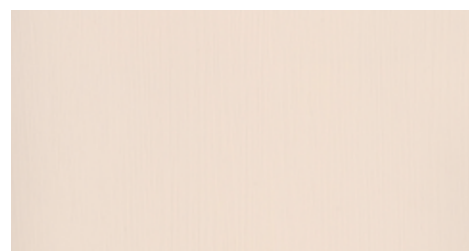

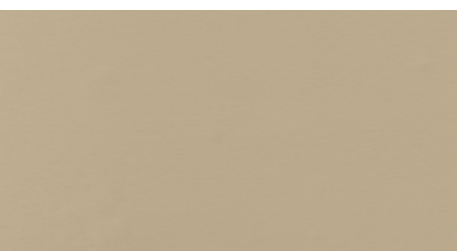

817
light ivory



818
light grey



819
grey



820
kensington grey

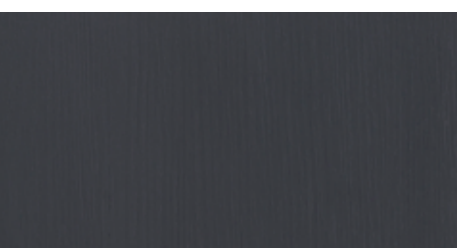

821
anthracite grey



822
windsor

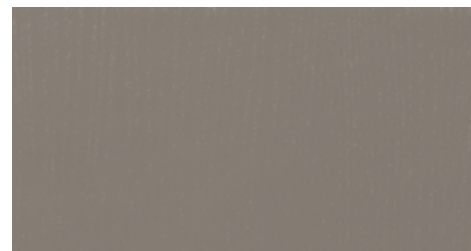

823
balmoral



824
dark red



825
wine red



826
dark green



827
brown



828
black-brown

⊕ selekta RENOLIT -
mountain oak - 836



Accessories

Initial and attachment profile

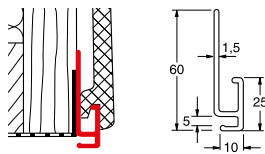

Initial profile N + F

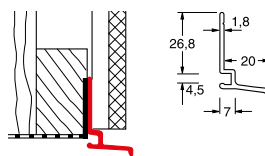

Attachment profile

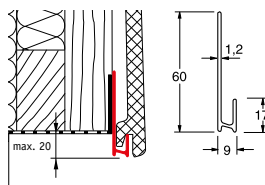

Initial profile P

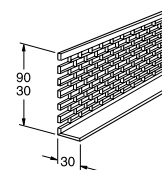

Ventilation profile

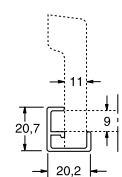

Edge-end profile 2

Corner transitions

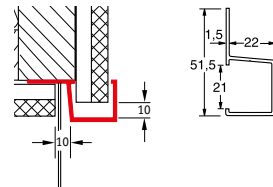

Connection profile F

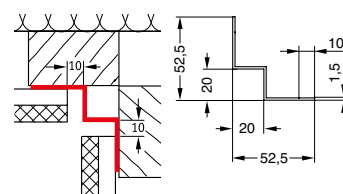

Aluminum inside corner profile

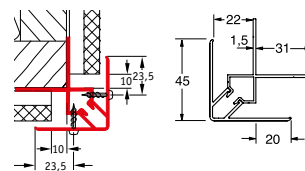

Outside corner C

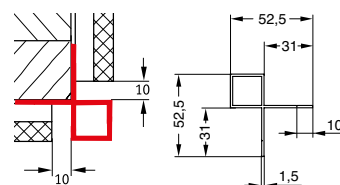

Aluminum outside corner profile

Butt joints

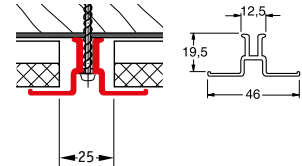

Cover profile

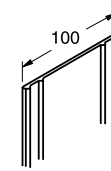

Joint tape

Profile ends

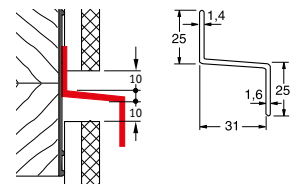

Z profile 1

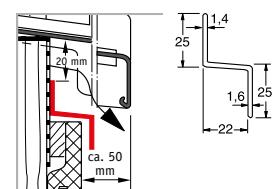

Z profile 2

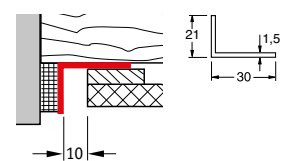

Cover angle 30/20



Download the latest installation instructions

Laying options

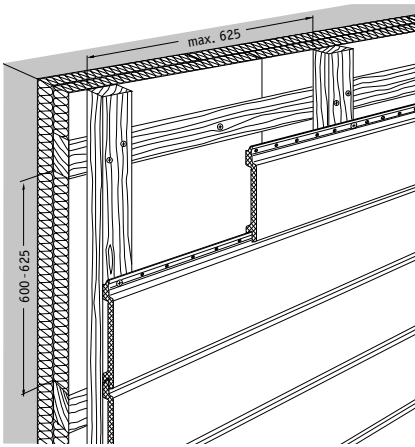

1. Horizontal installation (selekta)

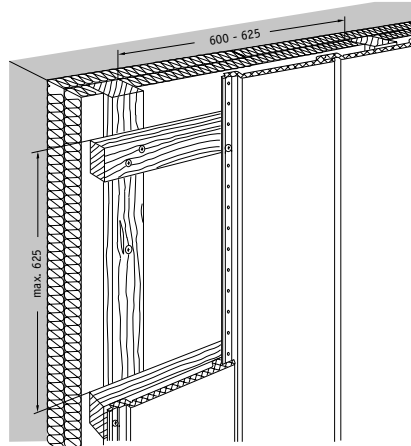

2. Vertical installation (selekta)

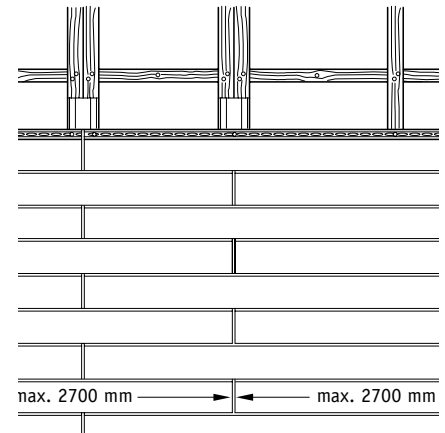

3. Horizontal installation in ship composite (selekta)

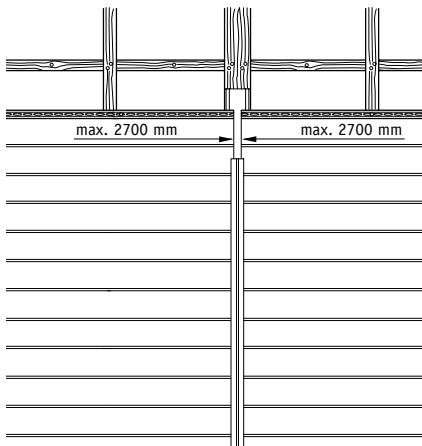

4. Horizontal installation with a vertical joint, clad with a cover profile (selekta)

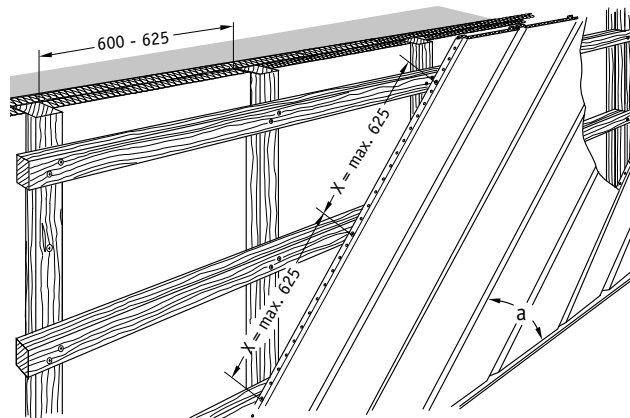

5. Diagonal installation (selekta)

Matching the selekta façade profile, WERZALIT offers an extensive range of corrosion-resistant accessories that meet individual requirements with attractive detailed solutions in construction. In addition, there are large fastening distances of up to max. 625 mm, a ready-to-install tongue and groove connection and pre-punched fastening slots for the façade screws for uncomplicated and quick installation and thus for great economy.

square cladding panels

Large surfaces for big architecture

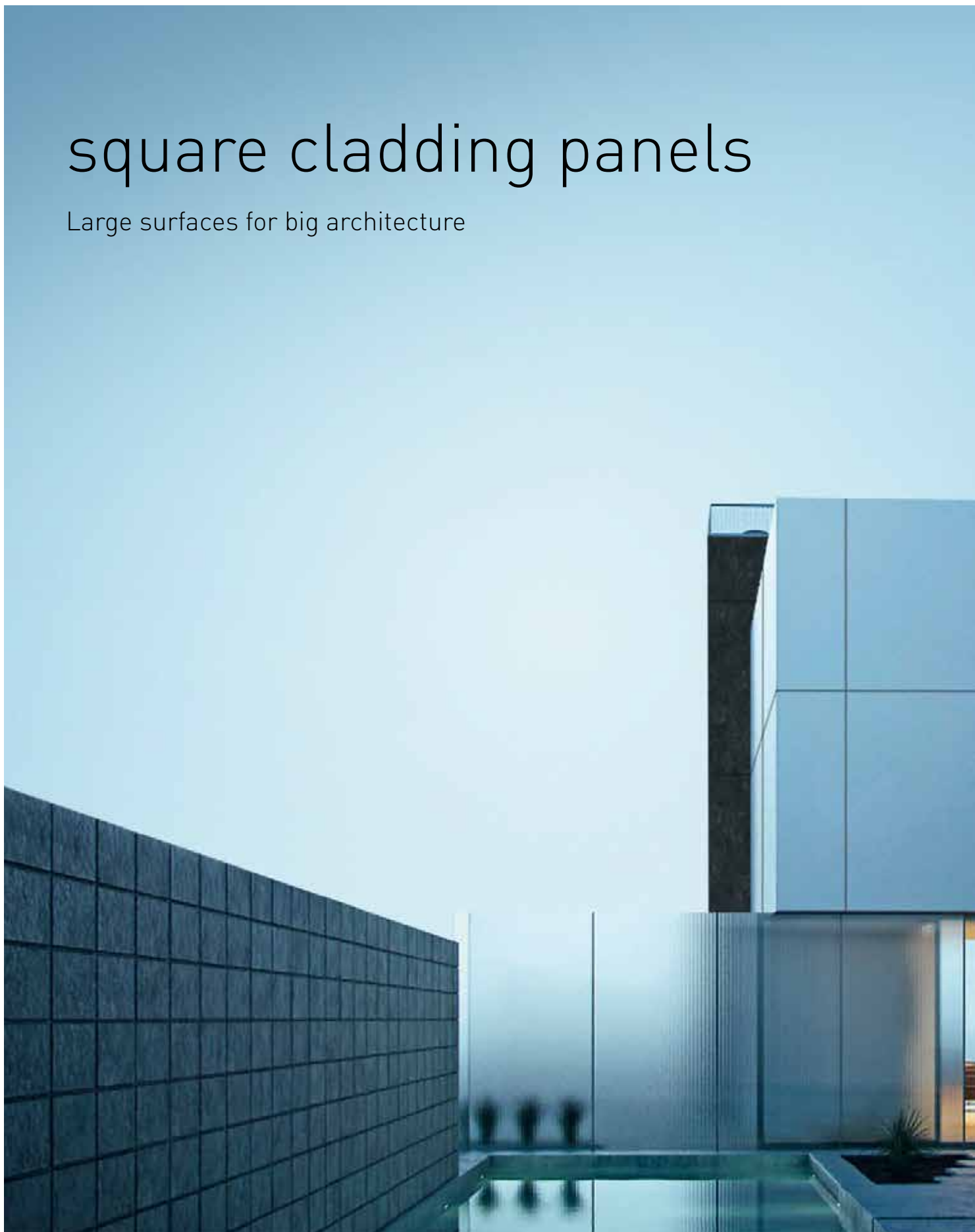



+ square cladding panel -
rain - 511

+ square cladding panel -
eternal iron - 885

The large facade

square cladding panel is attracting a lot of attention in modern façade design. The panels, coated on both sides, are available in four material thicknesses and three formats. With its generous format, SQUARE is not only suitable for cladding residential buildings, but also for designing industrial facades. SQUARE is available in the standard version in fire rating B2, but can also be supplied in fire rating B1 on request for an additional charge.

Easy to work with, versatile assembly

When it comes to installation, the square cladding panel behaves like wood. It can be riveted, screwed and glued. It can be attached visibly or concealed and attached to wooden or metal substructures.



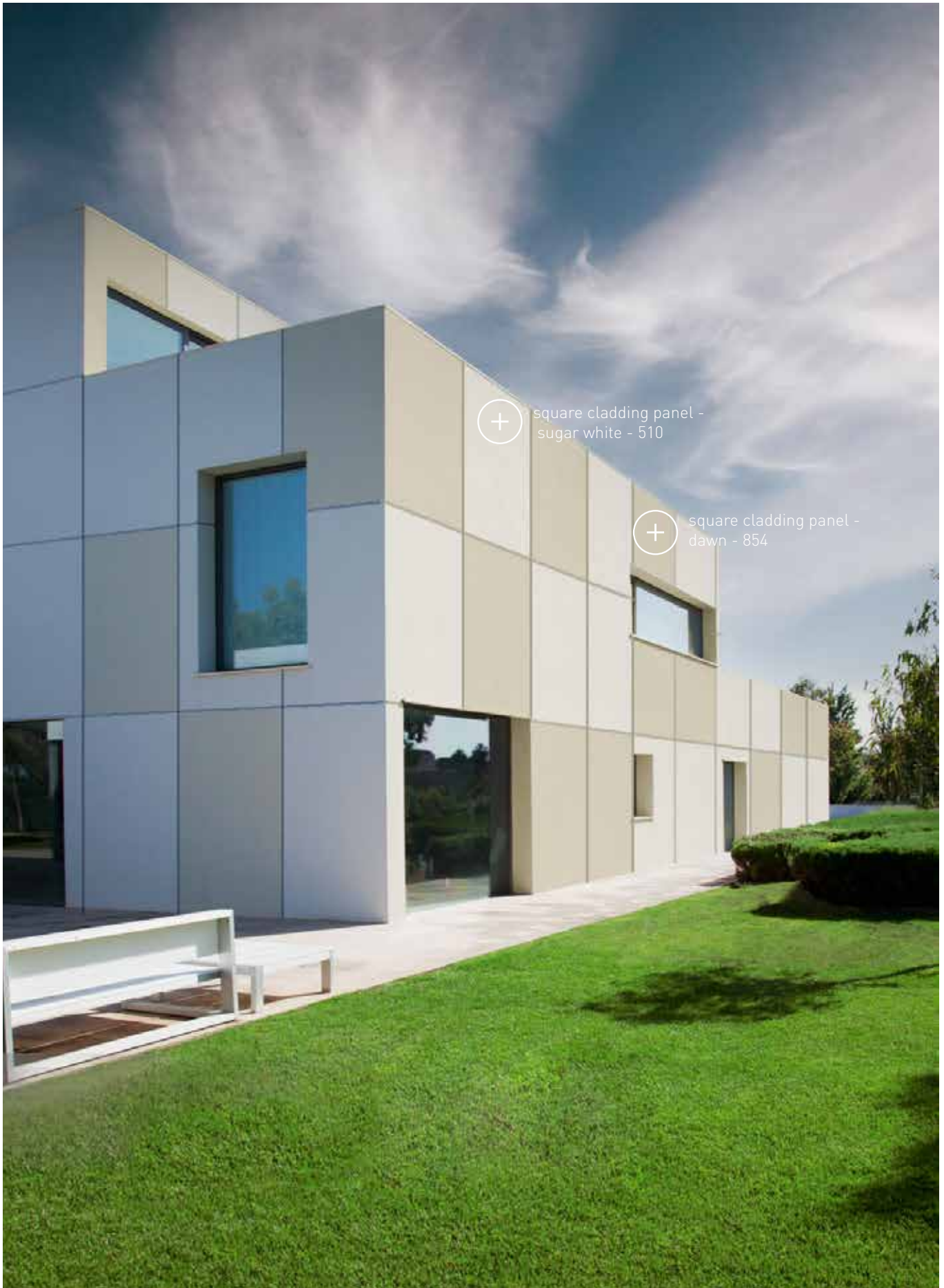

square

For large-area facade cladding. Available in three different formats up to max. 3.650 x 1.320 mm. Decoratively coated on both sides in the color lines Universal, Fantasy, Wood or Stone. Factory cuts to fixed dimensions possible.

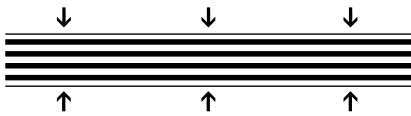

Cellulose webs/craft paper, impregnated with resin, are pressed into a homogeneous sheet.

Sizes

2180 x 1020 x 6/8/10/12 mm
fire protection class
B2*, B1**



3050 x 1320 x 6/8/10/12 mm
fire protection class
B2*, B1**



3650 x 1320 x 6/8/10/12 mm
fire protection class
B2*, B1**

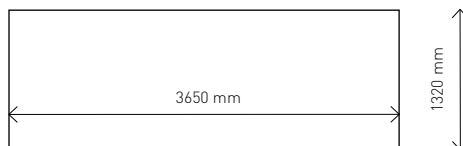

Accessories

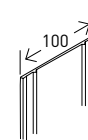

Joint tape

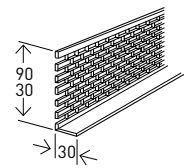

Ventilation profile

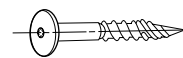

Universal screw
H 6 x 45 mm
Approved up to 8 m
Building height



Cover flap

*] Standard: B2 normal flammability

**] Optional B1 flame retardant.

Other strengths on request.



Universal



510
sugar white



518
ivory



512
silver grey



515
telegrey



516
tin



531
sunny

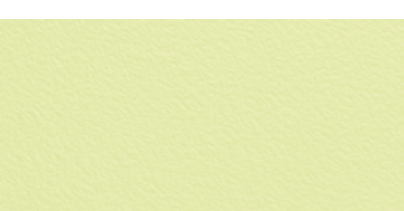

572
lime



553
blue ice

Fantasy



853
traffic white



514
pearl white

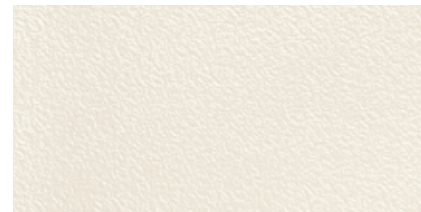

854
dawn

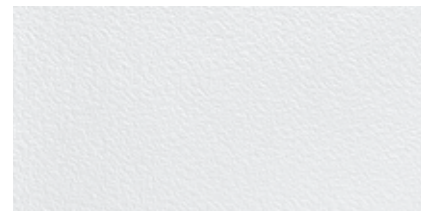

511
rain

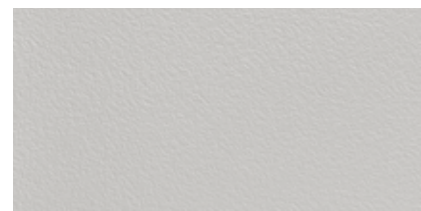

855
dove grey

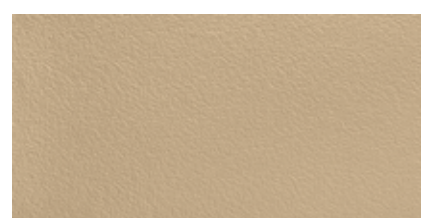

529
antilop

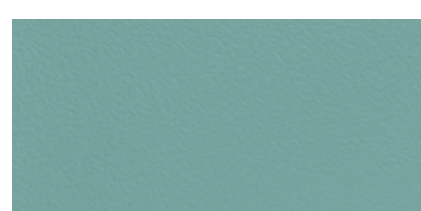

863
clear teal

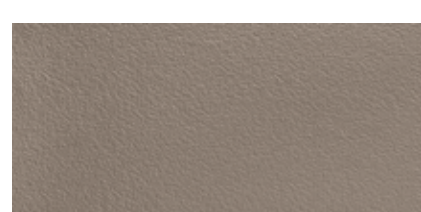

521
shadow

square



856
north sea

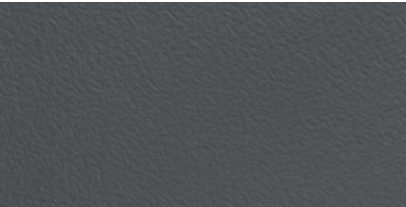

513
storm



517
ebony

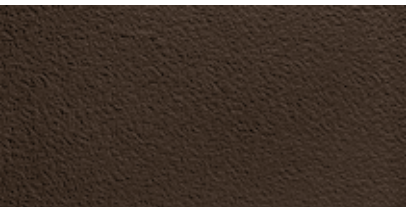

530
beaver



551
navy



861
port



858
brick



538
zinnia



542
infinity

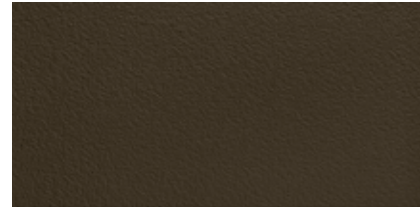

857
chocolate



866
parrot



867
moss

Wood
↓



877
unique elm



873
washy elm



584
sun teak



882
piave cherry



585
delight cherry



878
diego oak



879
pablo oak



880
delicious oak



881
novara elm



883
zebrano nightfall

Stone
↓



884
cloudy cement



885
eternal iron



886
patina rock



887
moon rock



888
corten



889
rubi limescale





selekta REFINE -
Colorpan pure white - 701

werzalit[®]
since 1923.



Window sills | Terraces | Facades | Balconies | Outdoor furniture

WERZALIT Deutschland GmbH

Bahnhofstraße Gernrode 45 | 37339 Gernrode

T: +49 (0) 360 7648 - 0 | E: info@werzalit.com

www.werzalit.com

All rights reserved. All texts, images, graphics and other information published here are subject to copyright and other laws intended to protect the intellectual property of WERZALIT Deutschland GmbH. All forms of duplication, the provision of access to third parties, distribution, storage, modification and reproduction of the content for commercial purposes is expressly prohibited without the written consent of WERZALIT Deutschland GmbH.

Due to print technology, all colours/finishes depicted in the brochure may vary from the original shades. We would be happy to provide you with original hand samples.

90.013.450
Version: 05/2023