



VIVIX®

VIVIX®

A FRESH PERSPECTIVE IN ARCHITECTURAL PANELS by FORMICA GROUP

All buildings featured in this brochure are clad with solid phenolic, engineered exterior facade panels manufactured by Formica Group. The buildings featured are for representative purposes to illustrate the results which may be possible using the VIVIX® product. The specific colours referenced represent either the actual installed colour or the closest equivalent from the new VIVIX product colour range.



A FRESH PERSPECTIVE IN ARCHITECTURAL PANELS *by* FORMICA GROUP

For nearly a century, Formica® brand surfacing solutions have defined the look and performance of modern interiors worldwide. Now, building on years of exterior cladding success in European markets, Formica Group remains on the cutting edge of building envelope art and science with the innovative exterior lightweight rainscreen cladding solution that redefines the landscape of contemporary construction for both new builds and renovations.



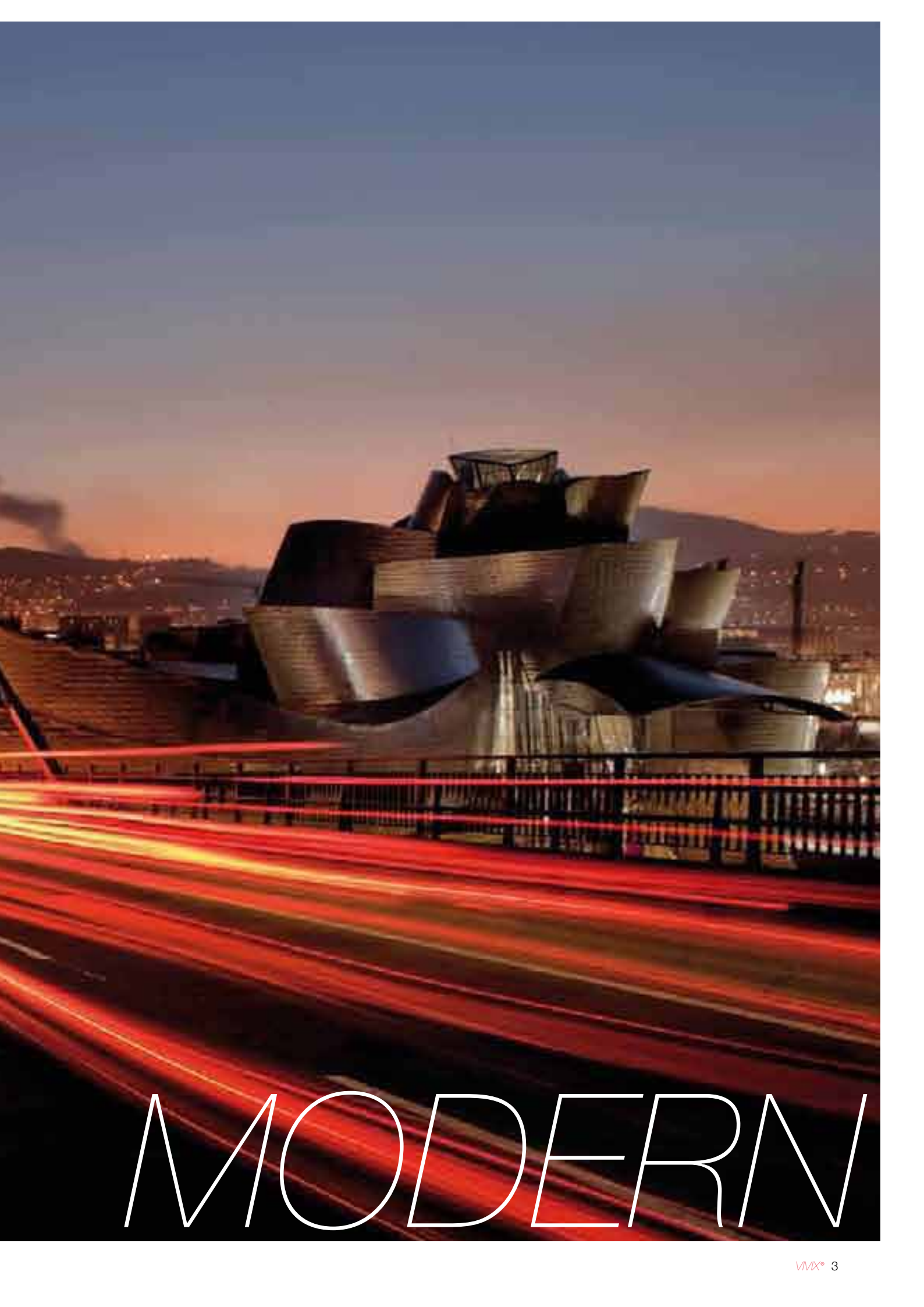

MODERN

EXTERIOR ARCHITECTURAL PANELS

VIVIX® solid phenolic, engineered exterior façade panels have a decorative surface on both sides. Robust and resilient, these rigid homogeneous panels are manufactured by Formica Group, using tough thermosetting resins reinforced with cellulose fibre for added strength and durability.

- *VIVIX* panels are resistant to impact and abrasion.
- *VIVIX* panels are UV and weather resistant and have been rigorously tested for severe use in accordance with EN 438-6&7.
- Available in an array of colours and patterns attuned to contemporary architecture and design.
- *VIVIX* panels are easily machined and can be cut into a variety of shapes and sizes to express virtually any design concept.
- Panels can be field modified as needed.
- *VIVIX* panels are easy to maintain and, in most cases, can simply be cleaned with mild detergent and water, in accordance with the Formica Group Use & Care Guide for *VIVIX* panels.



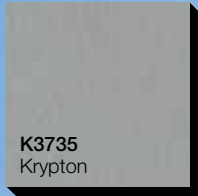
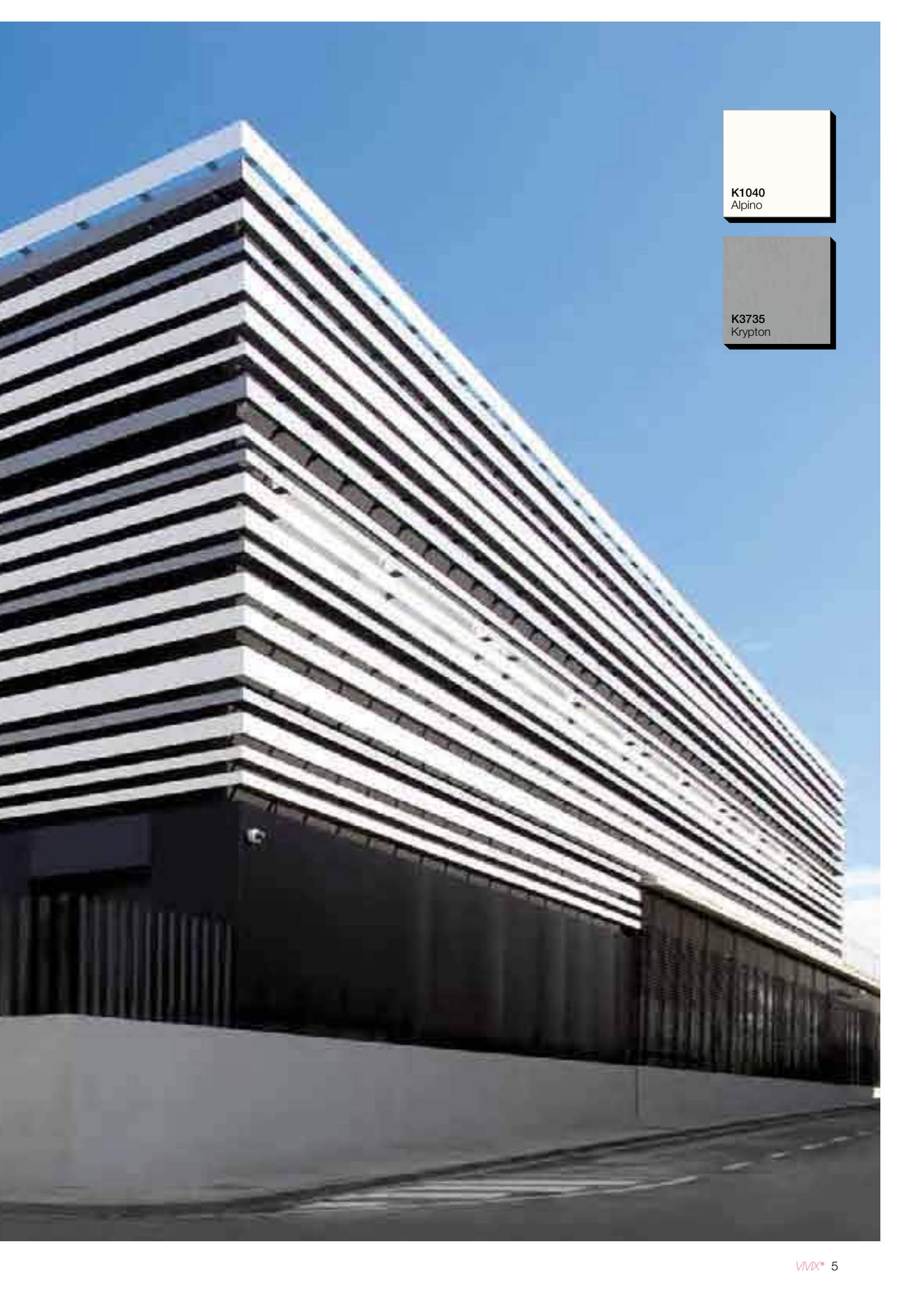



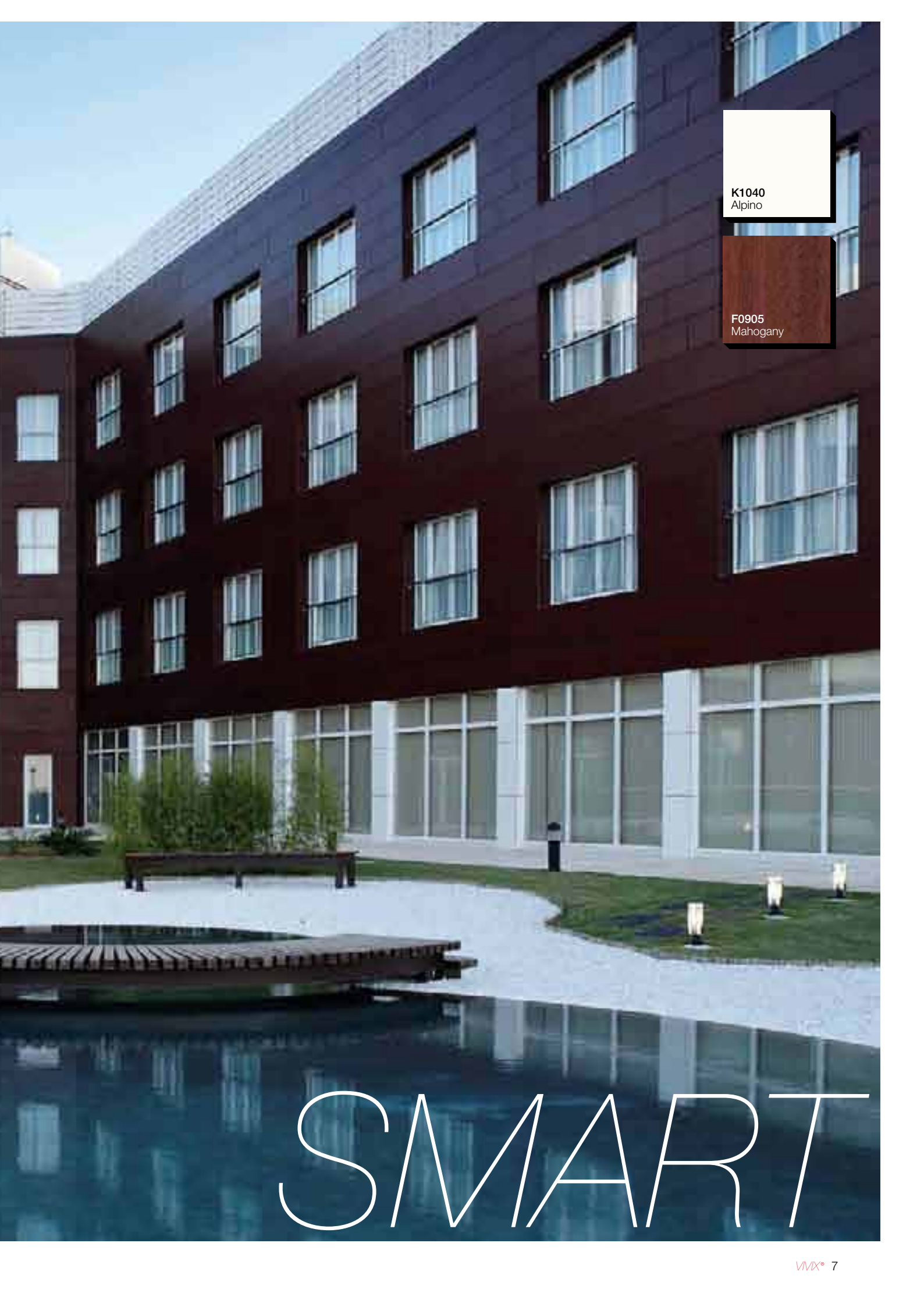

K1040
Alpino

F0905
Mahogany

SMART



VERSATILE

VIVIX® panels can be used to clad an entire building envelope, create individual design features, or be used in combination with other cladding materials, to enhance the look, function and life span of:

- office buildings
- hospitals and clinics
- schools and universities
- transportation centres
- industrial buildings
- cultural and sports facilities
- residential buildings
- hotels

The unique attributes of the *VIVIX* panels allow for a variety of exterior applications including:

- Rainscreen decorative façades
- Balconies
- Soffits
- Decorative screening and fencing
- Individual architectural features

K2010
Malibu

TOUGH

The image shows a modern building with a prominent blue rainscreen facade. The facade is composed of large, rectangular panels in various shades of blue. To the left, there is a tall, vertical glass chimney that reflects the sky and the building's structure. The building is set against a clear blue sky, and the foreground shows a paved area and a patch of green grass.

THE RAINSCREEN PRINCIPLE AND CLADDING PERFORMANCE

Rainscreen construction manages moisture, acting as a defence against water penetration and aiding in preventing adverse effects of moisture on building finishes and structural components.

A rainscreen ventilated façade system incorporates:

- cladding
- an air cavity
- drainage plane
- an airtight and watertight support wall

that together offer multiple moisture shedding pathways.

The continuous circulation of air in the cavity between the inner structure and the outer cladding skin helps moisture to evaporate and keeps the building dry and well-insulated, greatly minimizing the possible development of mould and mildew.

VIVIX[®] panels can be used with a variety of fixing systems, from simple timber battens to proprietary metal systems. *VIVIX* panels can be hung by visible face-fixing or by concealed fixing arrangements.



F7851
Spectrum Blue

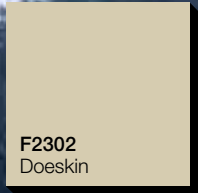

F2302
Doeskin



F7940
Spectrum Yellow

FRESH





F2510
Golden Morning Oak

PRACTICAL



RES

SUSTAINABILITY THROUGH DURABILITY

VIVIX® panels incorporate Formica Group's commitment to sustainable principles and practices. VIVIX panels are manufactured in Europe to ISO 9001 standards with minimal environmental impact as determined by Formica Group's product Life Cycle Assessment (LCA).

LCA tracks the ecological effects of a product throughout its lifespan from raw material procurement, manufacture and transport, to its use, reuse and disposal.

VIVIX Environmentally Responsible Attributes:

- Contains 3% of pre-consumer recycled wood fibre content (ISO 14021)
- Certified low-emitting by GreenGuard Environmental Institute
- Wood fibres used in the manufacturing process come from responsibly managed forests
- All colour pigments are free from heavy metals and solvents
- Multiple panel sizes optimize yield and minimize fabrication waste
- When used in rainscreen construction, VIVIX panels can contribute to a building's thermal efficiency
- May contribute toward optimized building energy performance and moisture regulation
- Manufacturing plants in Europe are accredited to ISO 14001 environmental management system
- Formica Group are FSC® certified and comply with the requirements of FSC. Network of participating European Formica Group sites is shown on certificate number TT-COC-003588.

RESPONSIBLE





K3735
Krypton

K1238
Carnaval

INNOVATIVE



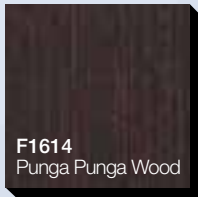
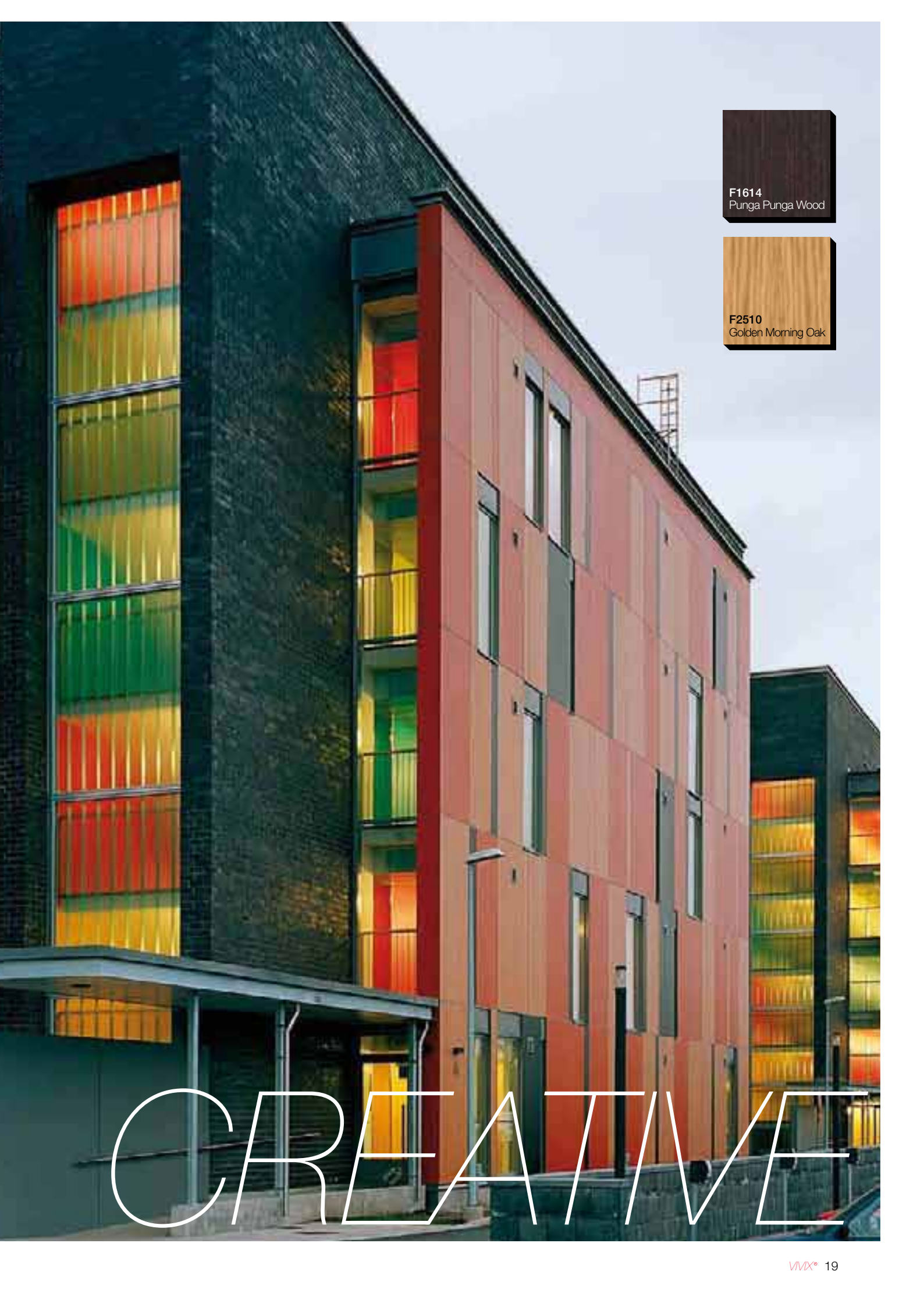

CREATIVE





K1040
Alpino

INTEGRATED

COLOURS

Developed in cooperation with leading architects and colour consultants, *VIVIX*[®] panel range choices include:

- plain colours in sophisticated neutrals and striking accents
- nature-inspired abstract patterns
- rich woodgrains

That allow the designer to create:

- a unique building identity
- accentuated architectural elements

All colours have undergone rigorous testing to ensure UV stability in accordance with EN 438-2 test methods 28 & 29 for colour fastness and weather resistance. Panels are tested for severe use compliance.



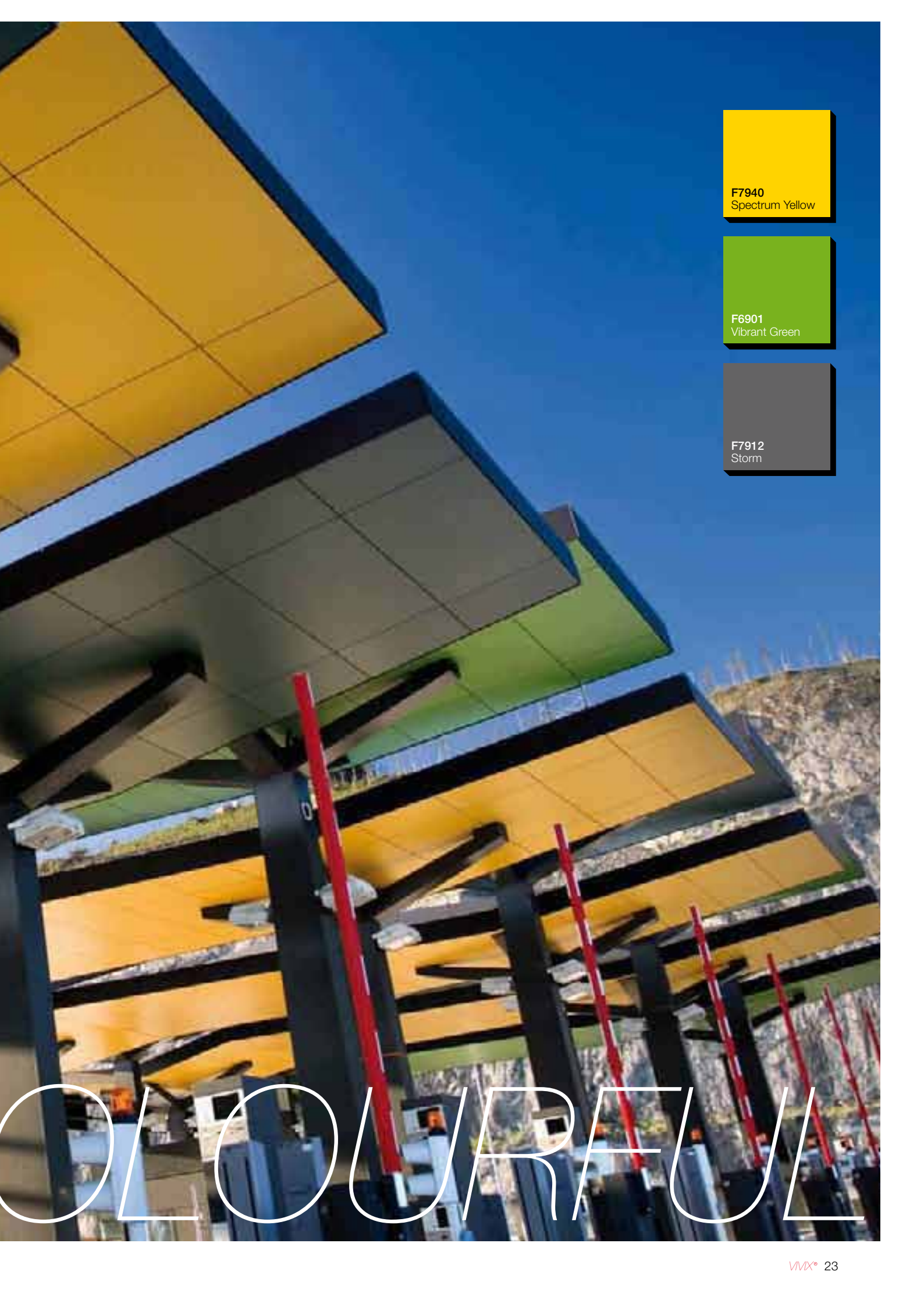

F7940
Spectrum Yellow

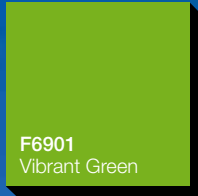

F6901
Vibrant Green



F7912
Storm

OURFUL





F3007
Pale Olive

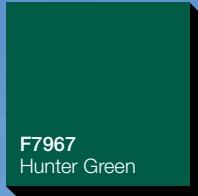

F7967
Hunter Green



F6901
Vibrant Green

DURABLE



ENVIRONMENTS

HOSPITALITY
OFFICES
RESIDENTIAL
HEALTHCARE
EDUCATION
INDUSTRIAL
TRANSPORT
LEISURE





SOLUTIONS

FAÇADES
BALCONIES
SOFFITS
FENCES
SHELTERS



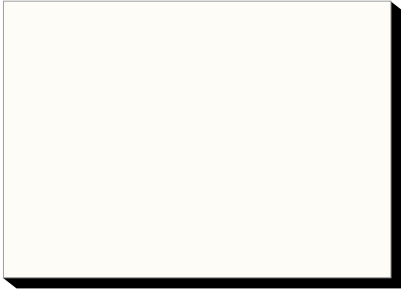

K1040 Alpino Matte 58

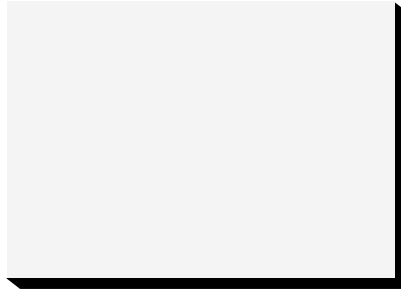

K2010 Malibu Matte 58

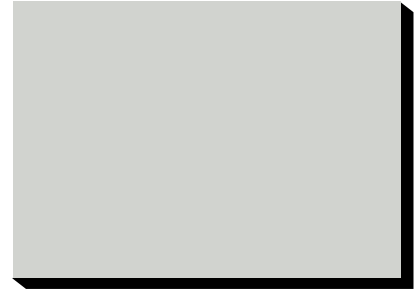

F7927 Folkestone Matte 58

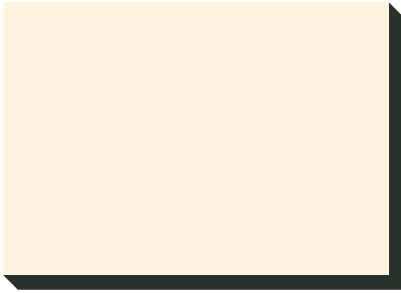

K1181 Irish Cream Matte 58

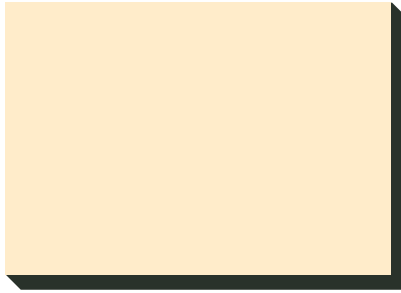

K1301 Gobi Matte 58



F2833 Sandstone Matte 58



F2288 Peach Matte 58



K1902 Eldorado Matte 58



K1903 Café Matte 58

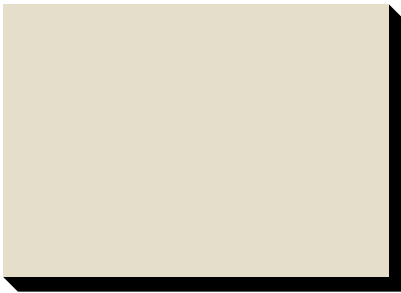

F7858 Pumice Matte 58



F7940 Spectrum Yellow Matte 58



F3007 Pale Olive Matte 58

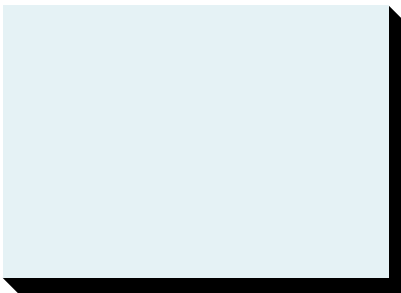

F5493 Arctic Blue Matte 58



K1998 Oslo Matte 58



F7884 China Blue Matte 58



F7853
Ocean Grey

Matte 58



K2020
Tornado

Matte 58



F7912
Storm

Matte 58



F2302
Doeskin

Matte 58



K1834
Kashmir

Matte 58



F2200
Dark Chocolate

Matte 58



F4161
Terracotta

Matte 58



K1238
Carnaval

Matte 58



K2005
Paprika

Matte 58

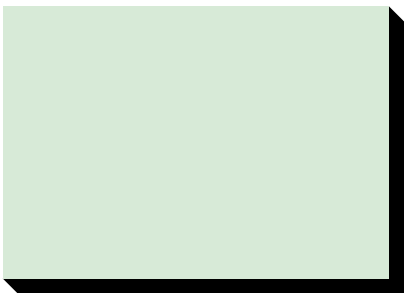

F2966
Opal

Matte 58



F6901
Vibrant Green

Matte 58



F7967
Hunter Green

Matte 58



F7851
Spectrum Blue

Matte 58



F7969
Navy Blue

Matte 58

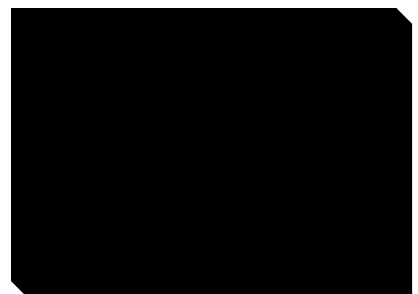

F2253
Diamond Black

Matte 58



F3855
Clear Maple

Matte 58



F5530
Savoy Beech

Matte 58

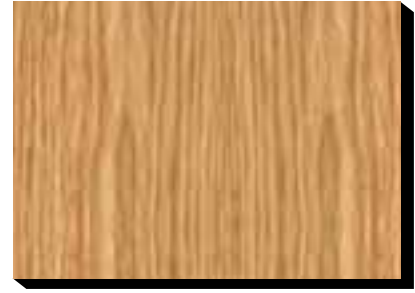

F2510
Golden Morning Oak

Matte 58



F5532
Erable Whisky

Matte 58



F5511
Vosges Pear

Matte 58



F5513
Redwood

Matte 58



F0905
Mahogany

Matte 58

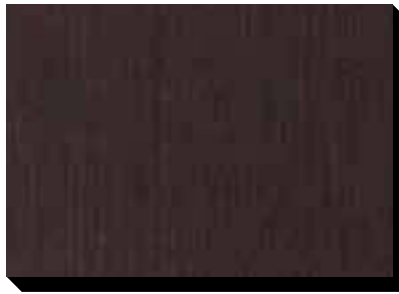

F1614
Punga Punga Wood

Matte 58



F5488
Smoky Brown Pear

Matte 58



K3735
Krypton

Matte 58



F1155
Marrón

Matte 58



F0163
Fantasía Marrón

Matte 58



K3734
Radon

Matte 58



Numerical listing

	Code	Name	Range	NCS®	RAL®	Finish
	F0163	Fantasia Marrón	Patterns			Matte 58
	F0905	Mahogany	Woods			Matte 58
	K1040	Alpino	Colors	S 0502-G50Y	9010	Matte 58
	F1155	Marrón	Patterns			Matte 58
	F1614	Punga Punga Wood	Woods			Matte 58
	K1181	Irish Cream	Colors	S 1005-Y50R		Matte 58
	K1238	Carnaval	Colors	S 1580-Y90R	3001	Matte 58
	K1301	Gobi	Colors	S 1010-Y30R		Matte 58
	K1834	Kashmir	Colors	S 5010-Y30R		Matte 58
	K1902	Eldorado	Colors	S 1020-Y20R	1014	Matte 58
	K1903	Café	Colors	S 3020-Y20R		Matte 58
	K1998	Oslo	Colors	S 3020-B		Matte 58
	K2005	Paprika	Colors	S 4050-Y80R		Matte 58
	K2010	Malibu	Colors	S 1000-N		Matte 58
	K2020	Tornado	Colors	S 4500-N	7036	Matte 58
	F2200	Dark Chocolate	Colors	S 8005-Y80R	8017	Matte 58
	F2253	Diamond Black	Colors	S 9000-N	9011	Matte 58
	F2288	Peach	Colors	S 1515-Y40R		Matte 58
	F2302	Doeskin	Colors	S 2010-Y		Matte 58
	F2510	Golden Morning Oak	Woods			Matte 58
	F2833	Sandstone	Colors	S 2010-Y30R		Matte 58
	F2966	Opal	Colors	S 1010-G10Y		Matte 58
	F3007	Pale Olive	Colors	S 3020-G60Y		Matte 58
	K3734	Radon	Patterns			Matte 58
	K3735	Krypton	Patterns			Matte 58
	F3855	Clear Maple	Woods			Matte 58
	F4161	Terracotta	Colors	S 3040-Y60R		Matte 58
	F5488	Smoky Brown Pear	Woods			Matte 58
	F5493	Arctic Blue	Colors	S 0510-R90B		Matte 58
	F5511	Vosges Pear	Woods			Matte 58
	F5513	Redwood	Woods			Matte 58
	F5530	Savoy Beech	Woods			Matte 58
	F5532	Erable Whisky	Woods			Matte 58
	F6901	Vibrant Green	Colors	S 2060-G30Y	6018	Matte 58
	F7851	Spectrum Blue	Colors	S 3060-R80B		Matte 58
	F7853	Ocean Grey	Colors	S 3010-G20Y		Matte 58
	F7858	Pumice	Colors	S 2005-Y20R		Matte 58
	F7884	China Blue	Colors	S 3020-R90B		Matte 58
	F7912	Storm	Colors	S 6502-B	7015	Matte 58
	F7927	Folkestone	Colors	S 2500-N		Matte 58
	F7940	Spectrum Yellow	Colors	S 1070-Y10R	1023	Matte 58
	F7967	Hunter Green	Colors	S 7020-G	6005	Matte 58
	F7969	Navy Blue	Colors	S 7020-R80B	5013	Matte 58

Panel Sizes
(mm)

3050 x 1300
3660 x 1525

Grades
(EN 438-6)

EDS¹
EDF²

Thicknesses
(mm)

6,0
8,0
10,0

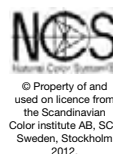

Please note that colour systems and their notations represent the closest colour available in the particular colour system and are provided for guidance only.

Designs given in this publication have been matched as closely as printing conditions allow. We do recommend, however, that you order samples before final specification, fabrication or installation, as the colour samples in the brochure may differ in shade, hue, tone or brightness to the products purchased.

¹ EDS: Exterior grade, severe use, standard grade.

² EDF: Exterior grade, severe use, flame-retardant grade B-s1,d0.

Product description

VIVIX® solid phenolic, engineered exterior façade panels have a decorative surface on both sides. Robust and resilient, these rigid homogeneous panels are manufactured by Formica Group, using tough thermosetting resins reinforced with cellulose fibre for added strength and durability.

An acrylic overlay provides enhanced UV protection and VIVIX panels have been rigorously tested for severe use in accordance with EN 438-6, making them ideal for applications in ventilated rainscreen façades and other external building elements.

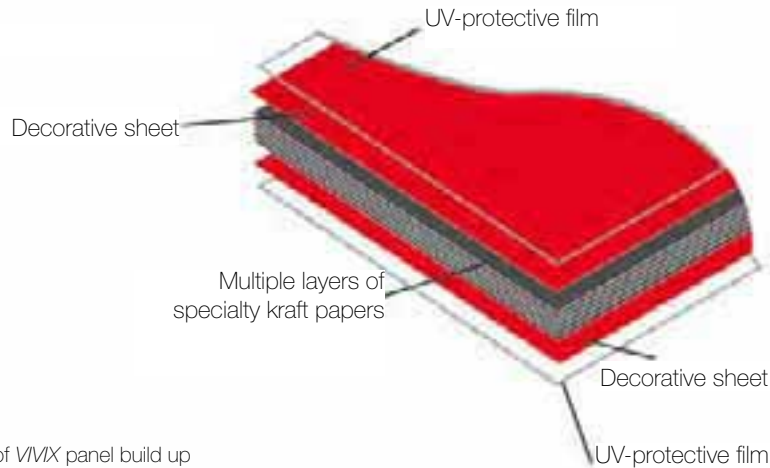

Figure 1.- Diagram of VIVIX panel build up

VIVIX architectural panels for ventilated rainscreen façades and other external building elements

Ventilated rainscreen façades with VIVIX panels are made up of the following elements:

- VIVIX panel in EDS or EDF grade
- Air cavity
- Thermal insulation
- Substructure, which transmits load to the structural wall
- Elements that attach panels to the substructure

VIVIX panel features and benefits

- Broad range of decorative panels
- Optimal modulation using different sized panels
- UV resistant
- Durability
- Weather resistant
- Impact resistant
- VIVIX panels do not rot and are highly resilient against cracking
- Mechanical and chemical properties unchanged in testing at 180°C
- Meets Fire Safety Standards. Does not melt or drip
- Easy to clean and maintain
- Dimensional stability and flatness
- Lightweight
- Low static electricity, does not attract dust
- Quick and easy to assemble
- Minimal maintenance
- No thermal bridge
- Limits heat loss in winter and the transmission of heat in summertime
- Overall lightweight substructure and façade

All features and benefits are subject to fair wear and tear and wilful damage, misuse or negligence by the buyer or user.

UV and weather resistance cannot be confirmed where the panels are located in places with climatic sunlight energy conditions exceeding those in EN 438-2, test methods 28 & 29.

These drawings indicate typical fixing arrangements on various supporting structures. Please contact your Formica Group representative for other possibilities. Any information or suggestions concerning applications, specification or compliance with regulations and standards is provided solely for your convenient reference and without any representation as to accuracy or suitability. The user must verify and test the suitability of any information or products for his or her particular purpose or specific application.

Technical drawings in this brochure should be considered as general examples of how VIVIX panels can be installed, there are other profiles and systems available in the market for ventilated façades which are not shown in this brochure. Consideration needs to be given to local circumstances, for example climate, wind load and local building regulations.

Figure A. - Rainscreen system in detail with visible attachments

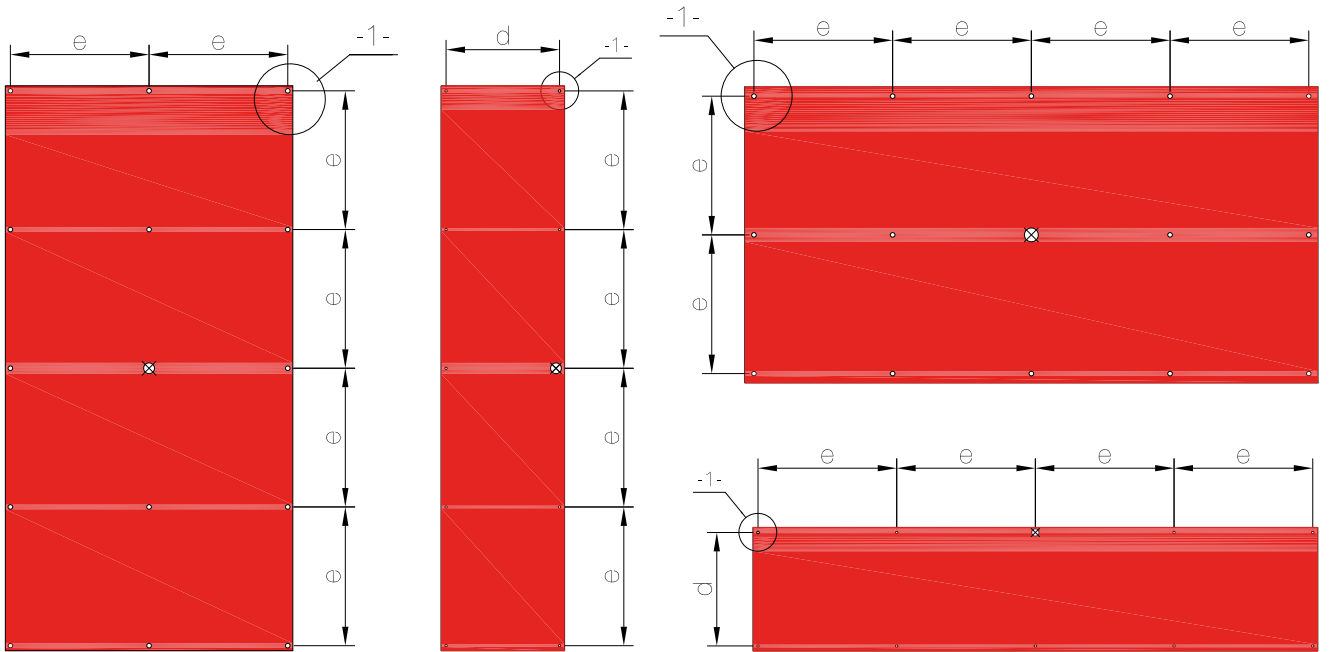
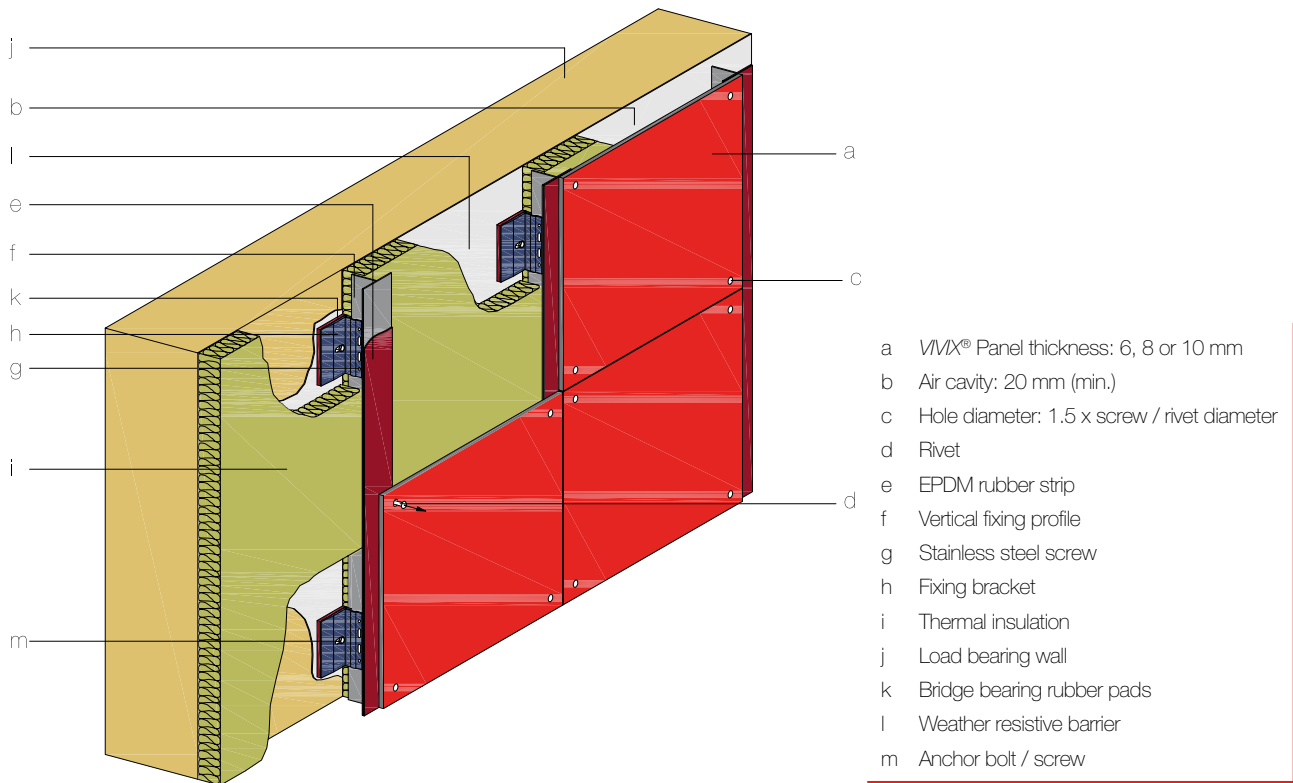

⊗ Fixed point: 1 x screw / rivet diameter (typically 5 mm)

Scale 1:30

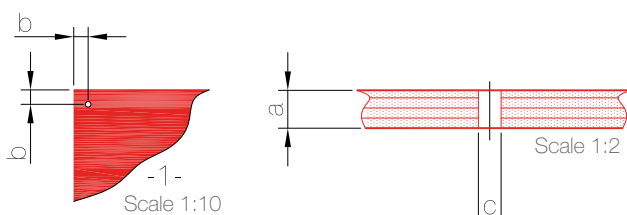

- a VMX Panel thickness: 6, 8 or 10 mm
- b Typical edge distance: min 20 mm - max see table on right
- c Hole diameter: 1.5 x screw / rivet diameter
- d Spacing: 450 mm, 600 mm, 750 mm (2 fixings in one direction)
- e Spacing: 550 mm, 750mm, 900 mm (3 or more fixings in one direction)

	b	d	e
VMX Panel thickness: 6 mm	60 mm (max)	450 mm	550 mm
VMX Panel thickness: 8 mm	80 mm (max)	600 mm	750 mm
VMX Panel thickness: 10 mm	100 mm (max)	750 mm	900 mm

Figure B. - Rainscreen system in detail with concealed attachments

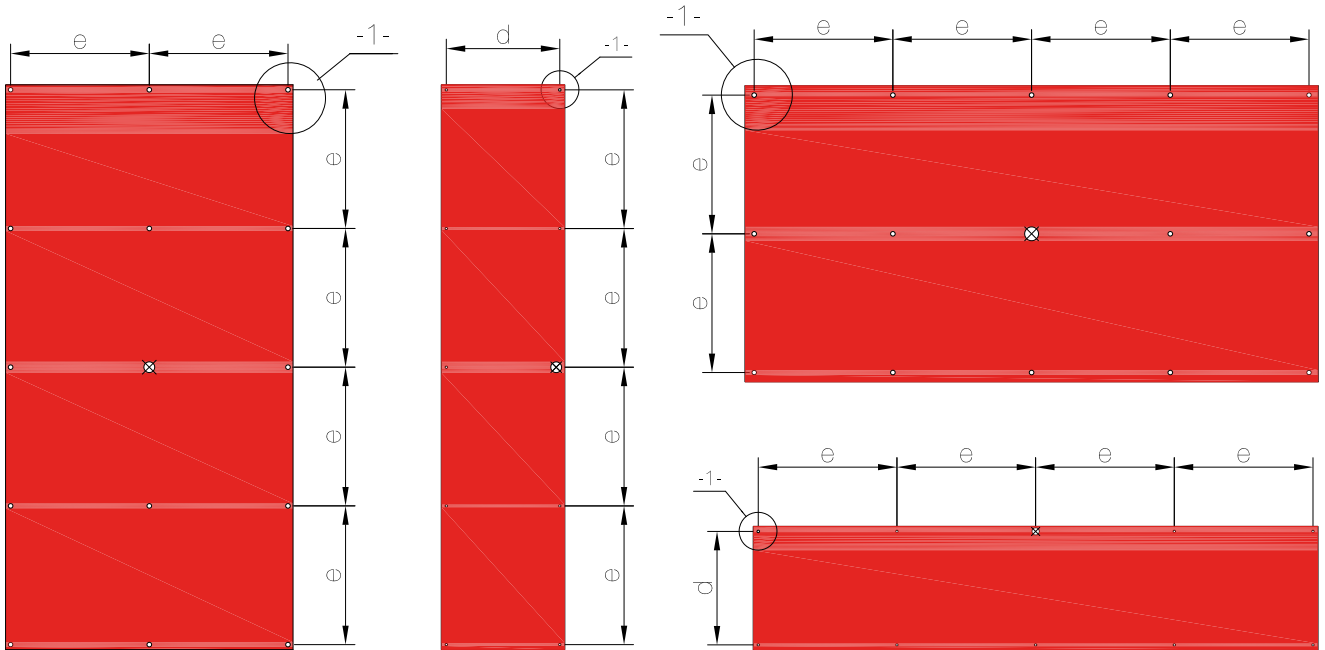
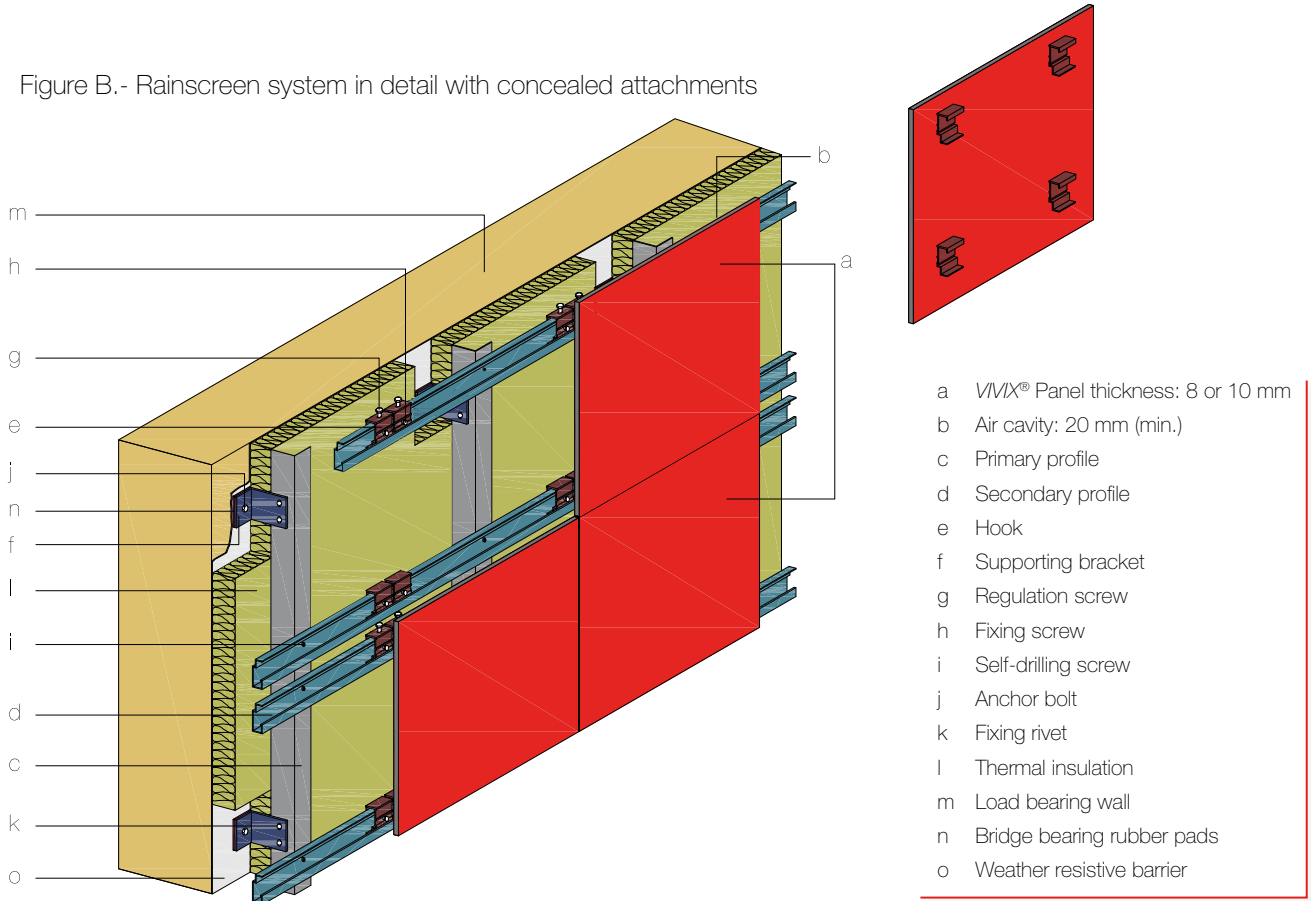

⊗ Fixed point: 1 x screw / rivet diameter (typically 5 mm)

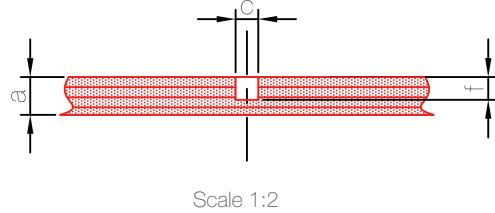
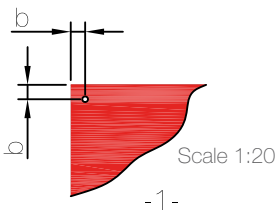

Scale 1:30

- a VIVIX Panel thickness: 8 or 10 mm
- b Min 75 mm - max see table on right
- c Diameter to suit fixing screw
- d Spacing: 750 mm, 900 mm (2 fixings in one direction)
- e Spacing: 600 mm, 750mm (3 or more fixings in one direction)
- f Fixing screw depth: 6 mm

	b	d	e
VIVIX Panel thickness: 8 mm	80 mm (max)	600 mm	750 mm
VIVIX Panel thickness: 10 mm	100 mm (max)	750 mm	900 mm

Figure C.- Rainscreen system in detail with visible attachments on wooden substructure

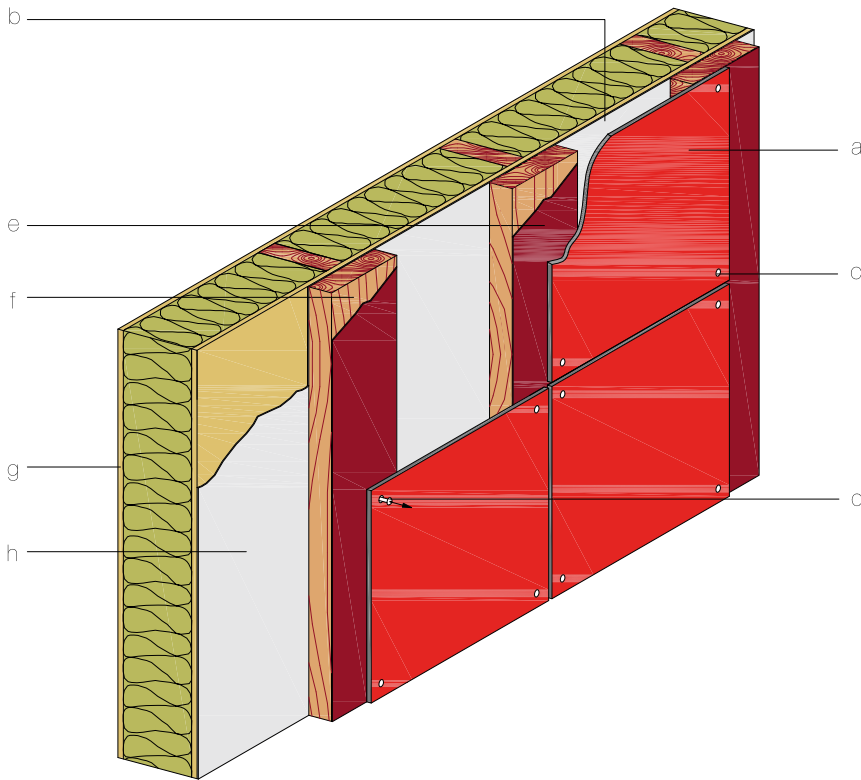

- a VVIX® Panel thickness: 6, 8 or 10 mm
- b Air cavity: 20 mm (min.)
- c Hole diameter: 1.5 x stainless screw diameter
- d Stainless screw
- e EPDM rubber strip
- f Vertical timber batten
- g Load bearing wall
- h Weather resistive barrier

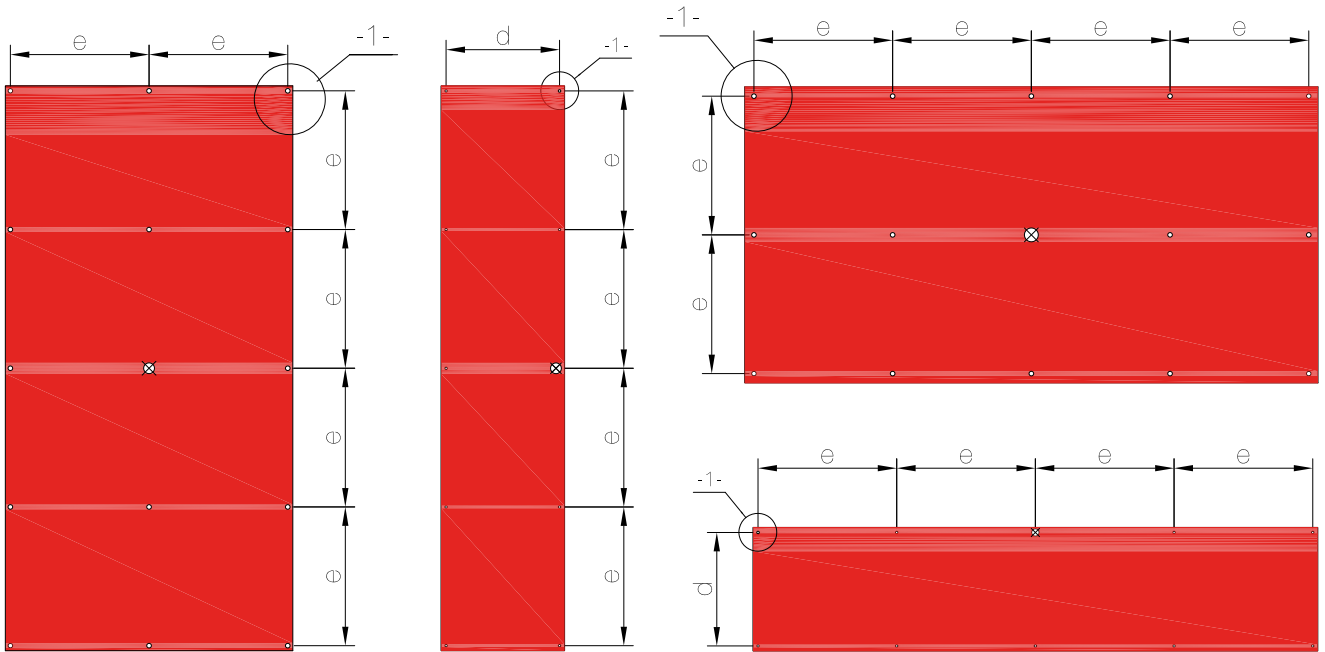

⊗ Fixed point: 1 x screw / rivet diameter (typically 5 mm)

Scale 1:30

- a VVIX Panel thickness: 6, 8 or 10 mm
- b Typical edge distance: min 20 mm - max see table on right
- c Hole diameter: 1.5 x screw / rivet diameter
- d Spacing: 450 mm, 600 mm, 750 mm (2 fixings in one direction)
- e Spacing: 550 mm, 750mm, 900 mm (3 or more fixings in one direction)

	b	d	e
VVIX Panel thickness: 6 mm	60 mm (max)	450 mm	550 mm
VVIX Panel thickness: 8 mm	80 mm (max)	600 mm	750 mm
VVIX Panel thickness: 10 mm	100 mm (max)	750 mm	900 mm

VIVIX® panels can be attached to a metal profile using rivets, screws and concealed attachments.

Construction details
 Metal substructure
 Visible attachment
 Horizontal cross-section

Scale 1:10

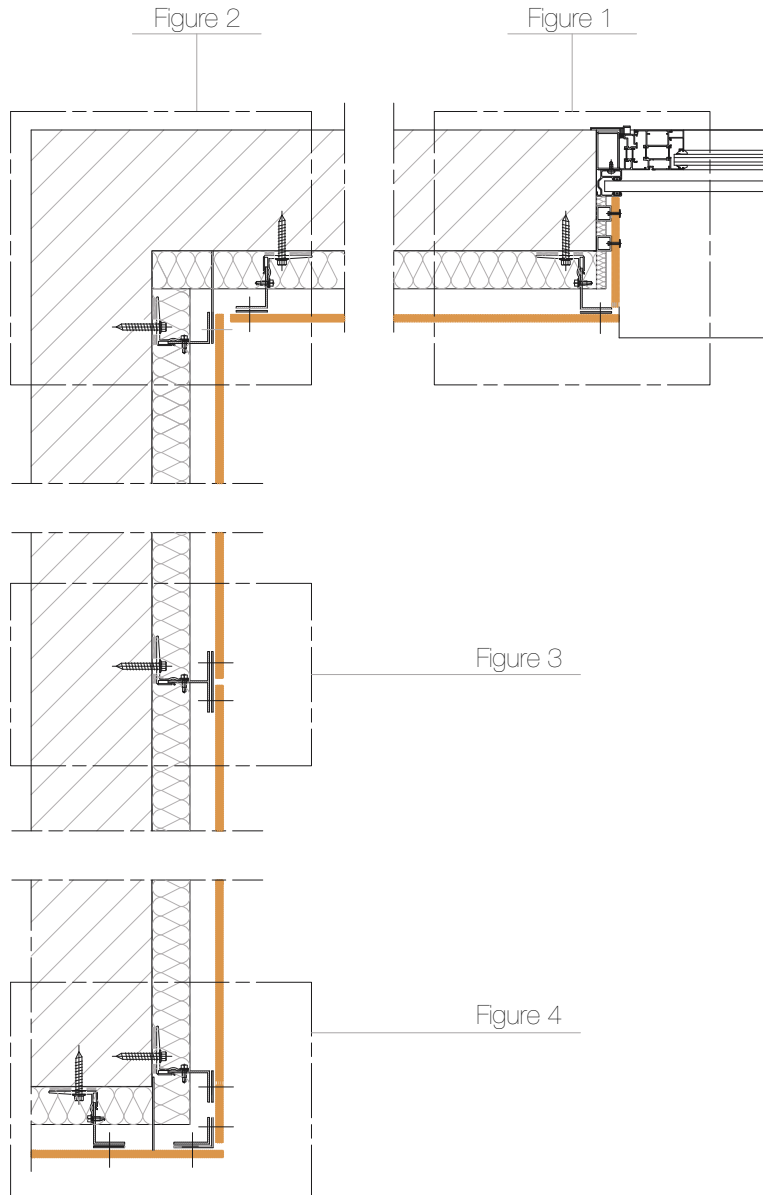

This drawing indicates a typical fixing arrangement on a metal supporting structure. Please contact your Formica Group representative for other possibilities. Any information or suggestions concerning applications, specification or compliance with regulations and standards is provided solely for your convenient reference and without any representation as to accuracy or suitability. The user must verify and test the suitability of any information or products for his or her particular purpose or specific application.

Technical drawings in this brochure should be considered as general examples of how VIVIX panels can be installed, there are other profiles and systems available in the market for ventilated façades which are not shown in this brochure. Consideration needs to be given to local circumstances, for example climate, wind load and local building regulations.

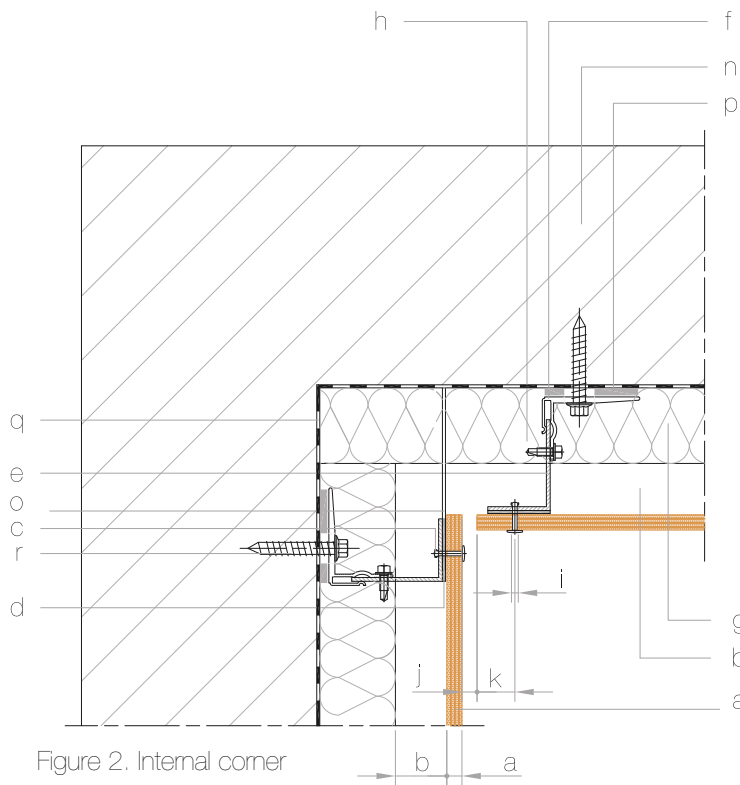

Figure 2. Internal corner

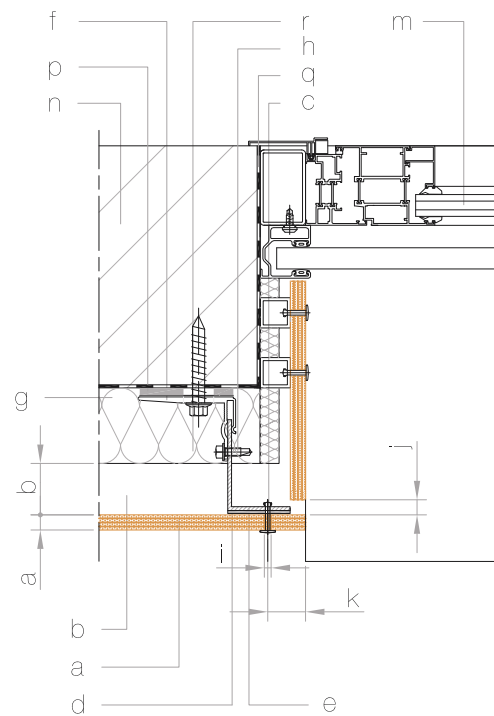

Figure 1. Window detail

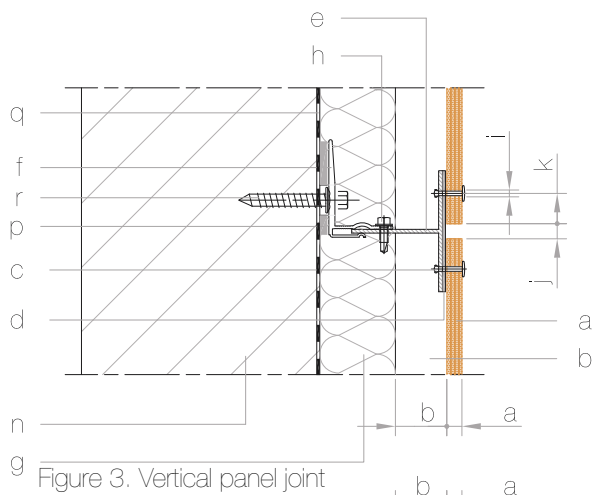

Figure 3. Vertical panel joint

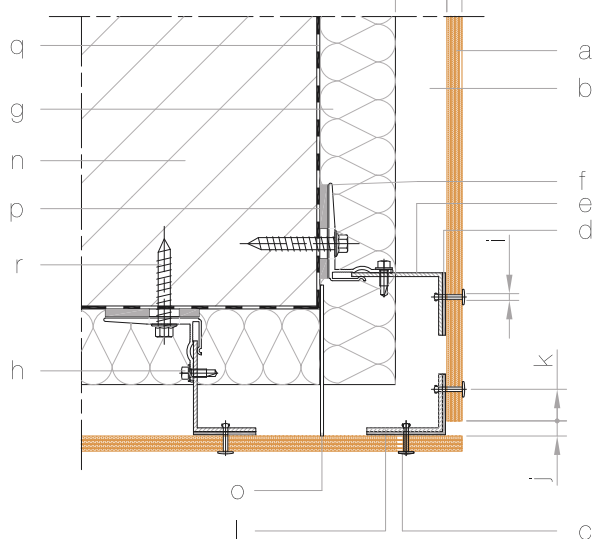

Figure 4. External corner

Scale 1:5

- a VVIX® Panel thickness: 6, 8 or 10 mm
- b Air cavity: 20 mm (min.)
- c Fixing rivet
- d EPDM rubber strip
- e Vertical fixing profile (L or T)
- f Fixing bracket
- g Thermal insulation
- h Stainless steel screw
- i Hole diameter: 1.5 x fixing rivet diameter
- j Min. joint dimension: 10 mm
- k Edge distance: min. 20 mm - max. 10 x panel thickness
- l Vertical profile "L"
- m Window
- n Load bearing wall
- o Aluminium plate (air cavity interruption)
- p Bridge bearing rubber pads
- q Weather resistive barrier
- r Anchor bolt / screw

Construction details
 Metal substructure
 Visible attachment
 Vertical cross-section

Scale 1:10

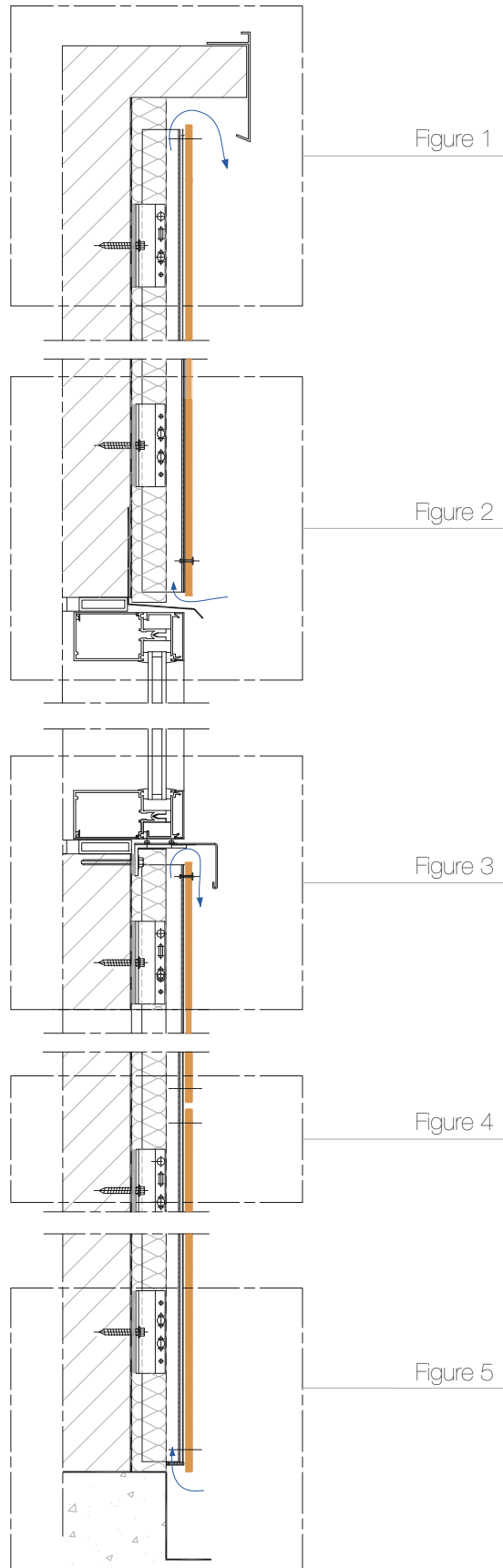

Figure 1

Figure 2

Figure 3

Figure 4

Figure 5

This drawing indicates a typical fixing arrangement on a metal supporting structure. Please contact your Formica Group representative for other possibilities. Any information or suggestions concerning applications, specification or compliance with regulations and standards is provided solely for your convenient reference and without any representation as to accuracy or suitability. The user must verify and test the suitability of any information or products for his or her particular purpose or specific application.

Technical drawings in this brochure should be considered as general examples of how VIVIX® panels can be installed, there are other profiles and systems available in the market for ventilated façades which are not shown in this brochure. Consideration needs to be given to local circumstances, for example climate, wind load and local building regulations.

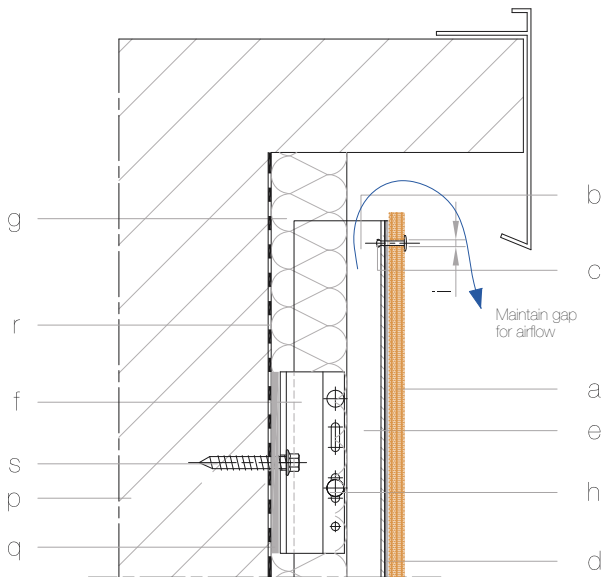

Figure 1. Top of wall

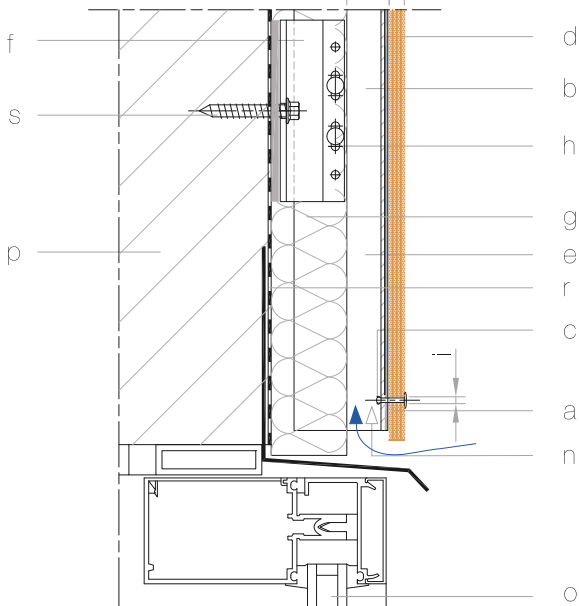

Figure 2. Window head

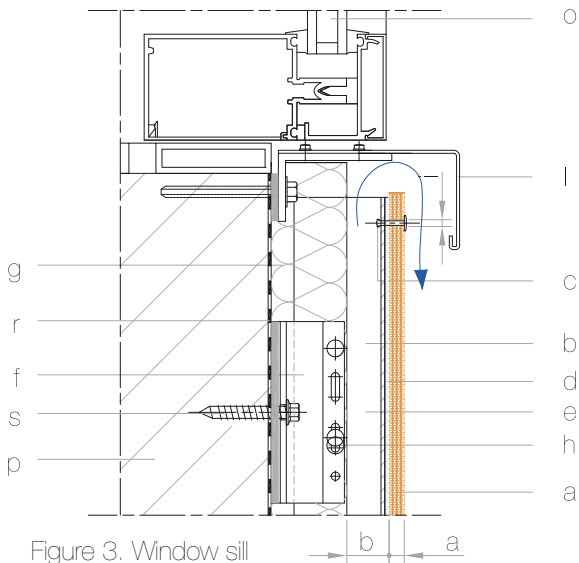

Figure 3. Window sill

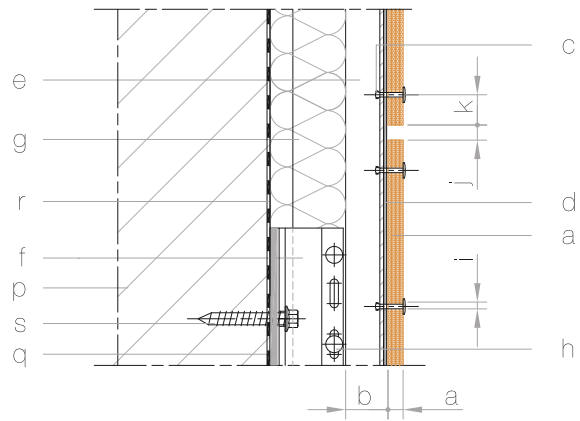

Figure 4. Horizontal panel joint

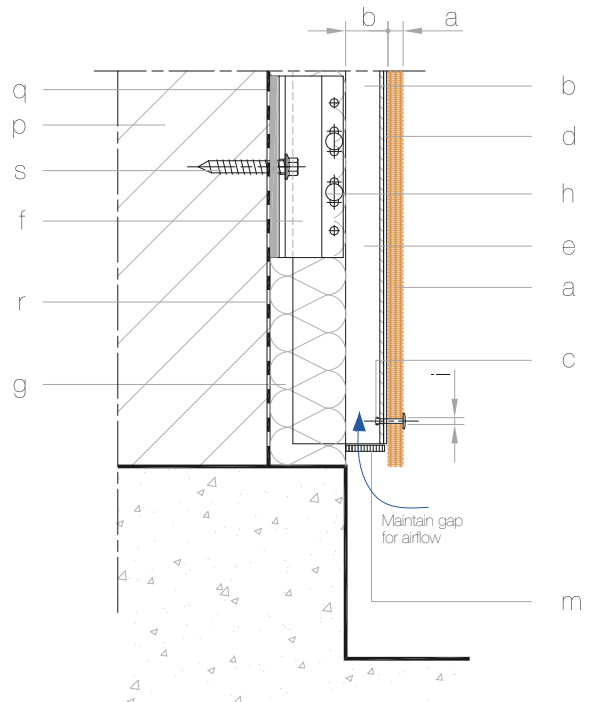

Figure 5. Bottom of wall

Scale 1:5

- a VVIX® Panel thickness: 6, 8 or 10 mm
- b Air cavity: 20 mm (min.)
- c Fixing rivet
- d EPDM rubber strip
- e Vertical fixing profile (L or T)
- f Fixing bracket
- g Thermal insulation
- h Stainless steel screw
- i Hole diameter: 1.5 x fixing rivet diameter
- j Min. joint dimension: 10 mm
- k Edge distance: min. 20 mm - max. 10 x panel thickness
- l Formed metal sheet
- m Ventilation grille
- n Ventilation distance: 50 cm²/m (min.)
- o Window
- p Load bearing wall
- q Bridge bearing rubber pads
- r Weather resistive barrier
- s Anchor bolt / screw

Construction details
 Metal substructure
 Concealed metal attachment
 Horizontal cross-section

Scale 1:10

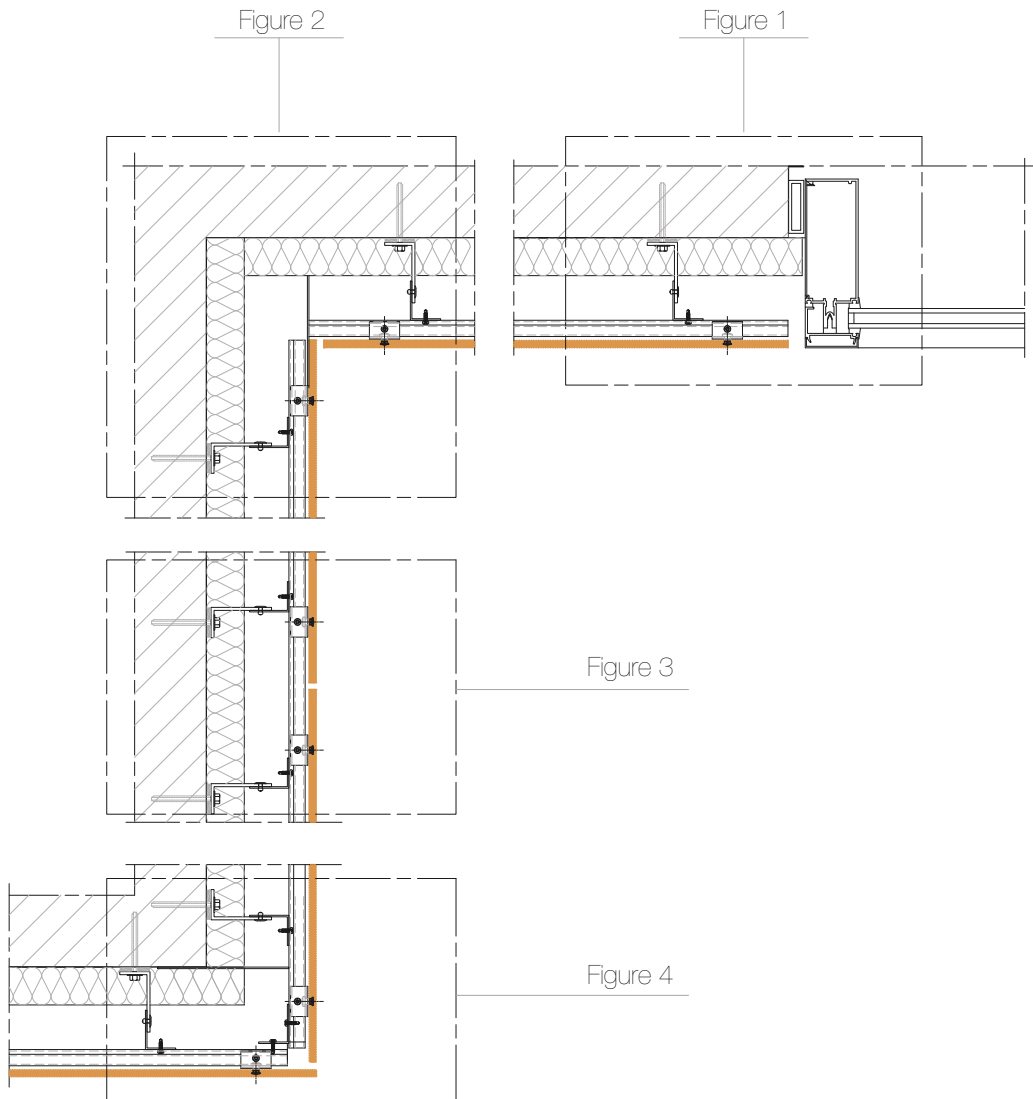

This drawing indicates a typical fixing arrangement on a metal supporting structure. Please contact your Formica Group representative for other possibilities. Any information or suggestions concerning applications, specification or compliance with regulations and standards is provided solely for your convenient reference and without any representation as to accuracy or suitability. The user must verify and test the suitability of any information or products for his or her particular purpose or specific application.

Technical drawings in this brochure should be considered as general examples of how VIVIX® panels can be installed, there are other profiles and systems available in the market for ventilated façades which are not shown in this brochure. Consideration needs to be given to local circumstances, for example climate, wind load and local building regulations.

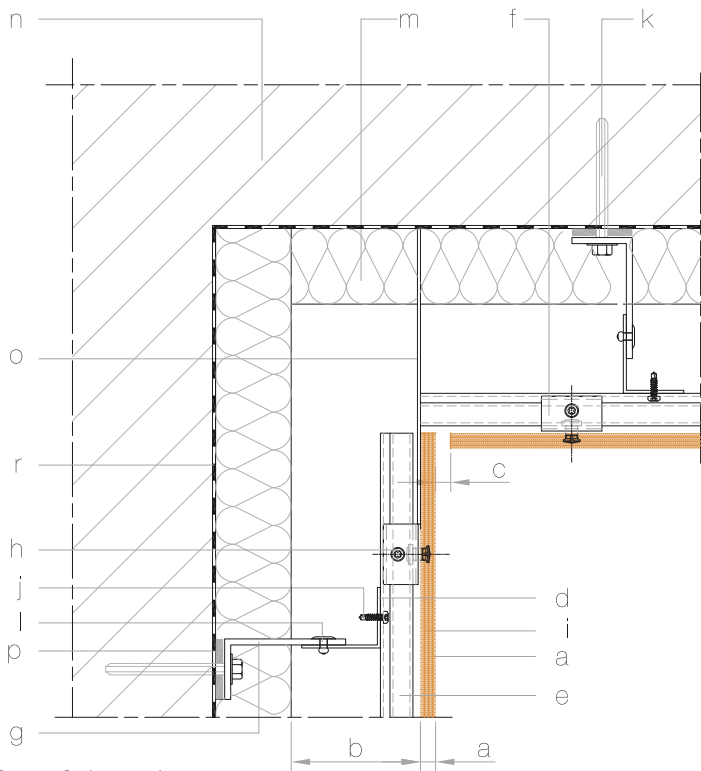

Figure 2. Internal corner

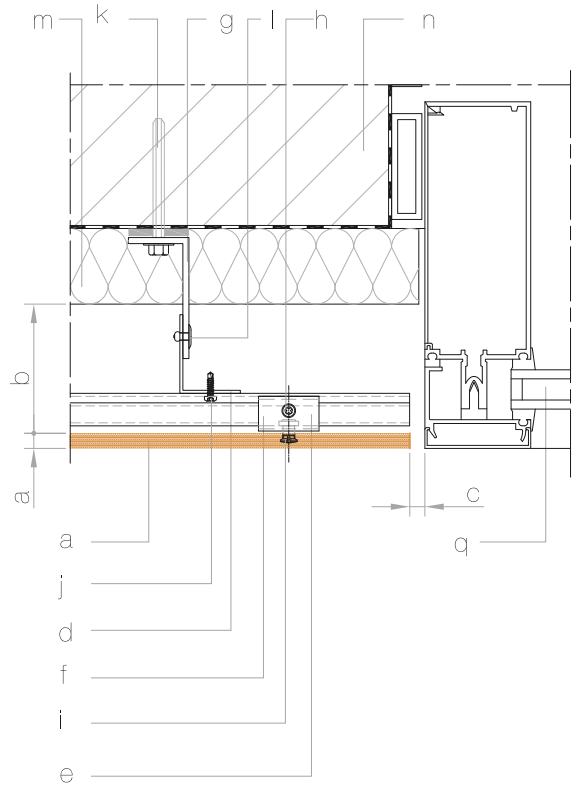

Figure 1. Window detail

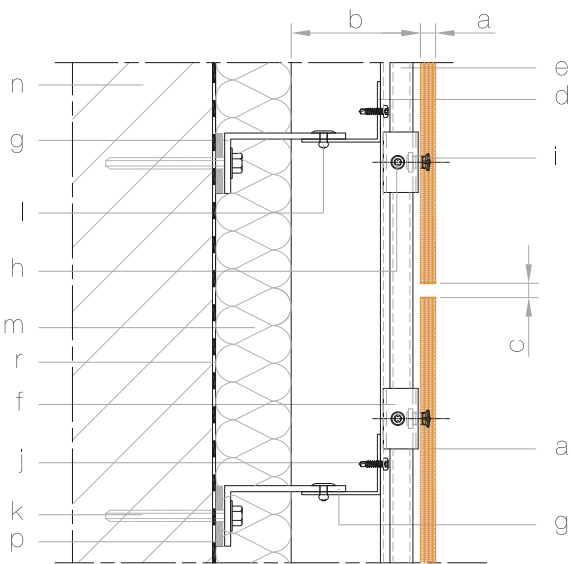

Figure 3. Vertical panel joint

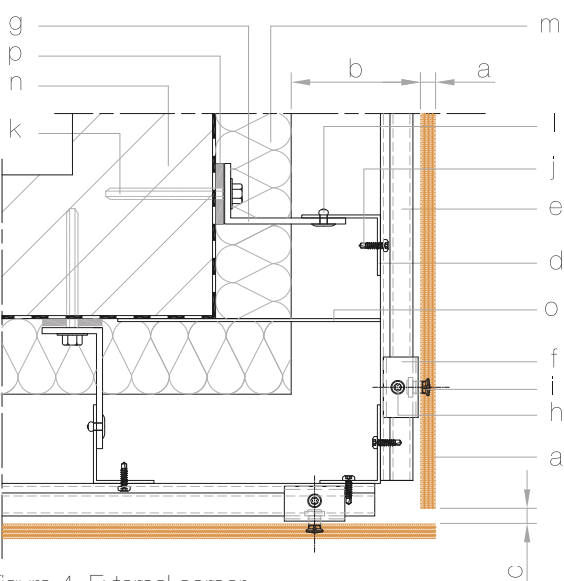

Figure 4. External corner

Scale 1:5

- a VVIK® Panel thickness: 8 or 10 mm
- b Air cavity: 20 mm (min.)
- c Min. joint dimension: 10 mm
- d Primary profile
- e Secondary profile
- f Hook
- g Supporting bracket
- h Regulation screw
- i Fixing screw
- j Self-drilling screw
- k Anchor bolt
- l Fixing bracket
- m Thermal insulation
- n Load bearing wall
- o Aluminium plate (air cavity interruption)
- p Bridge bearing rubber pads
- q Window
- r Weather resistive barrier

Construction details
 Metal substructure
 Concealed metal attachment
 Vertical cross-section

Scale 1:10

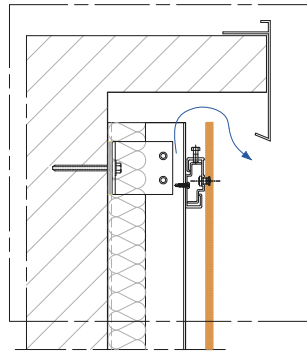

Figure 1

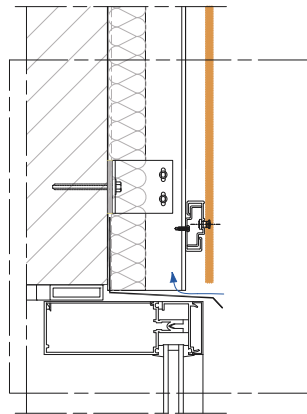

Figure 2

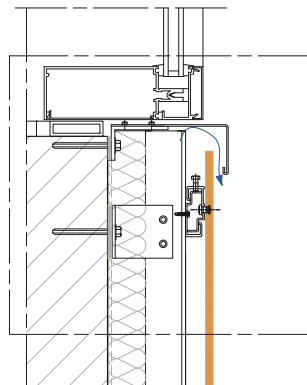

Figure 3

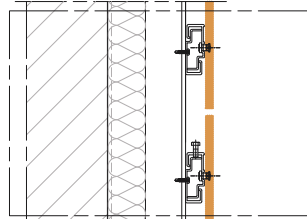

Figure 4

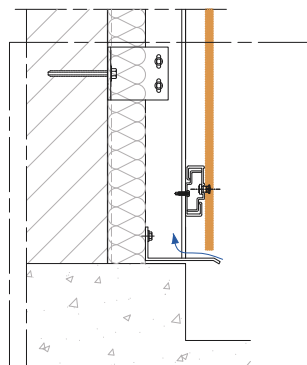

Figure 5

This drawing indicates a typical fixing arrangement on a metal supporting structure. Please contact your Formica Group representative for other possibilities. Any information or suggestions concerning applications, specification or compliance with regulations and standards is provided solely for your convenient reference and without any representation as to accuracy or suitability. The user must verify and test the suitability of any information or products for his or her particular purpose or specific application.

Technical drawings in this brochure should be considered as general examples of how VIVIX® panels can be installed, there are other profiles and systems available in the market for ventilated façades which are not shown in this brochure. Consideration needs to be given to local circumstances, for example climate, wind load and local building regulations.

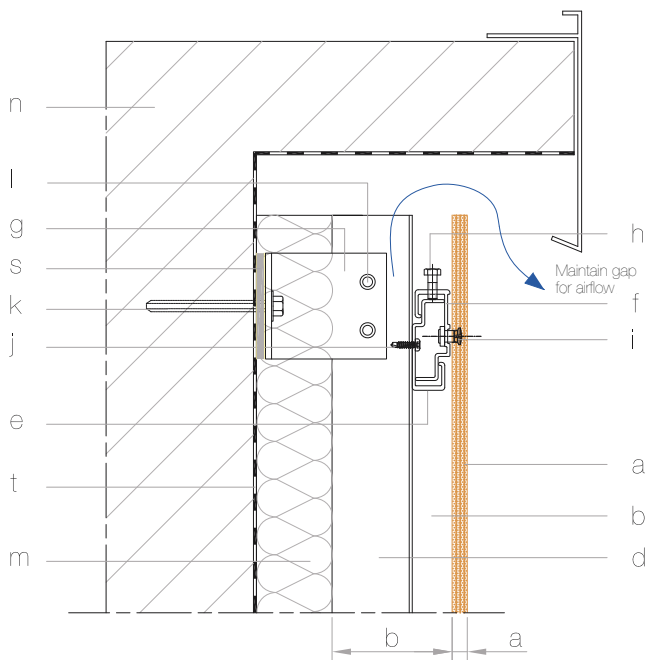

Figure 1. Top of wall

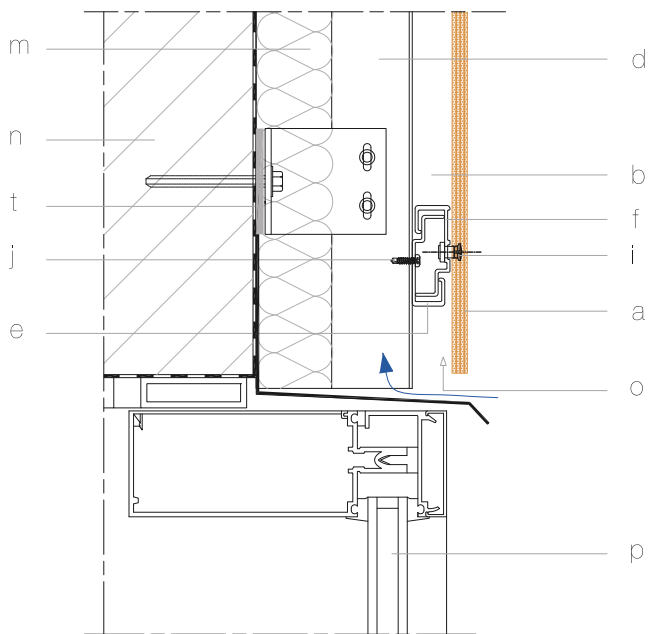

Figure 2. Window head

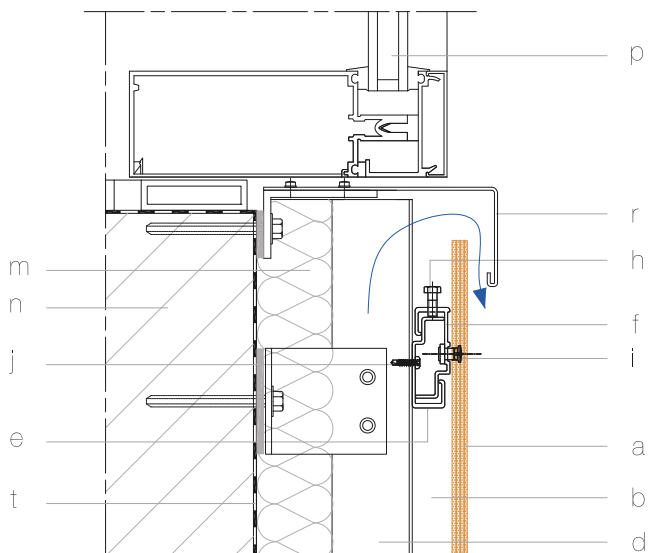

Figure 3. Window sill

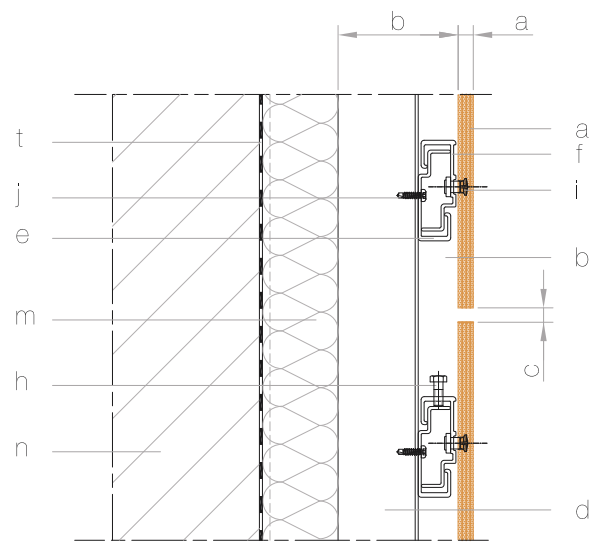

Figure 4. Horizontal panel joint

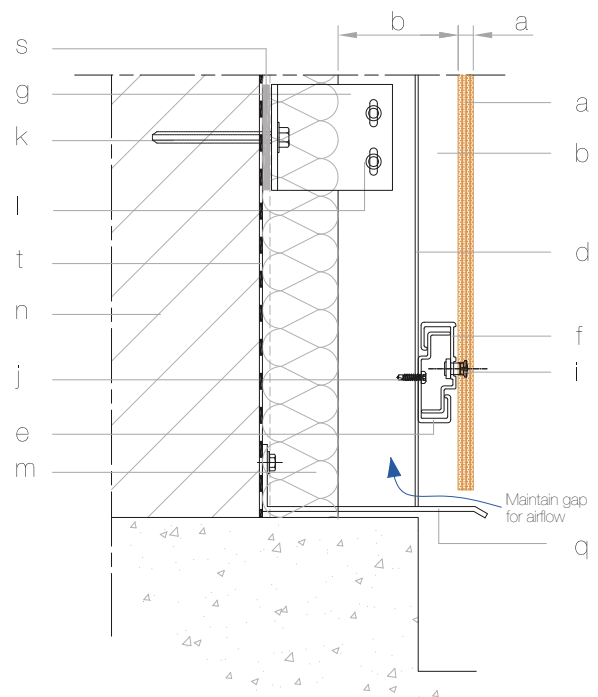

Figure 5. Bottom of wall

Scale 1:5

- a VIVIX® Panel thickness: 8 or 10 mm
- b Air cavity: 20 mm (min.)
- c Min. joint dimension: 10 mm
- d Primary profile
- e Secondary profile
- f Hook
- g Supporting bracket
- h Regulation screw
- i Fixing screw
- j Self-drilling screw
- k Anchor bolt
- l Fixing bracket
- m Thermal insulation
- n Load bearing wall
- o Ventilation distance: 50 cm²/m (min.)
- p Window
- q Formed metal sheet
- r Formed metal sill flashing
- s Bridge bearing rubber pads
- t Weather resistive barrier

Construction details
 Wooden substructure
 Visible attachment
 Horizontal cross-section

Scale 1:10

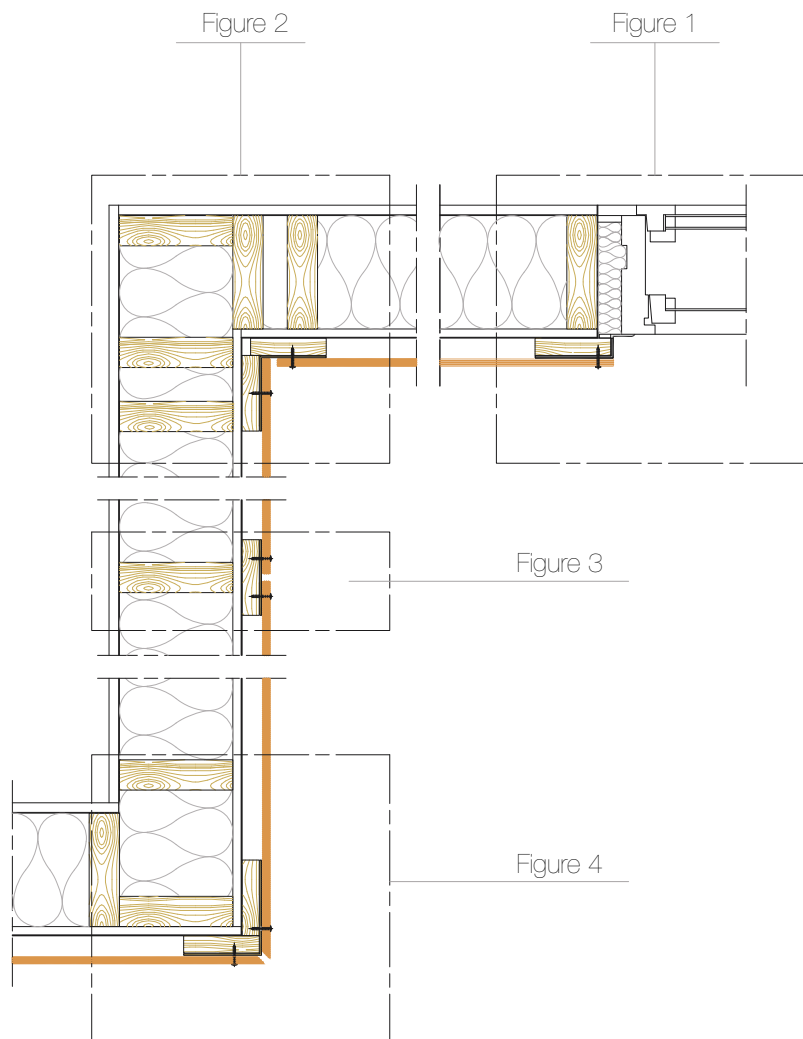

This drawing indicates a typical fixing arrangement on a wooden supporting structure. Please contact your Formica Group representative for other possibilities. Any information or suggestions concerning applications, specification or compliance with regulations and standards is provided solely for your convenient reference and without any representation as to accuracy or suitability. The user must verify and test the suitability of any information or products for his or her particular purpose or specific application.

Technical drawings in this brochure should be considered as general examples of how VIVIX® panels can be installed, there are other profiles and systems available in the market for ventilated façades which are not shown in this brochure. Consideration needs to be given to local circumstances, for example climate, wind load and local building regulations.

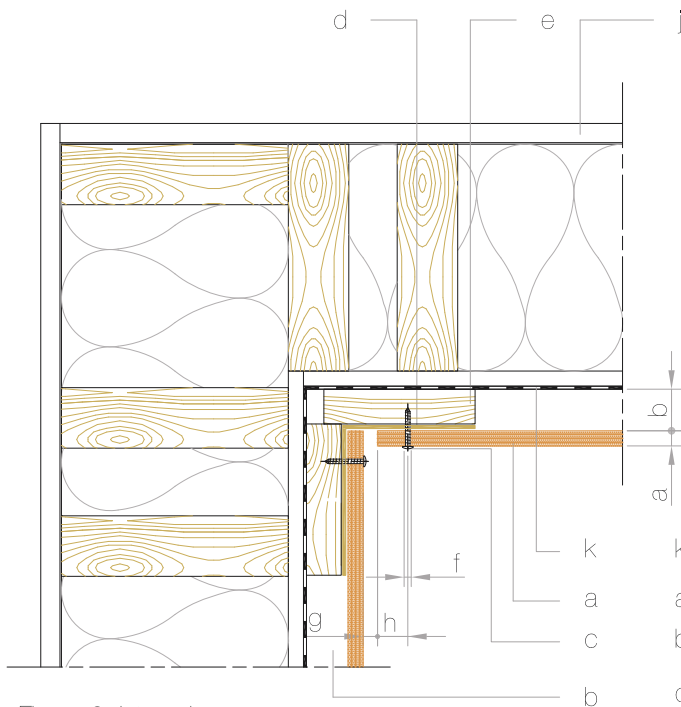

Figure 2. Internal corner

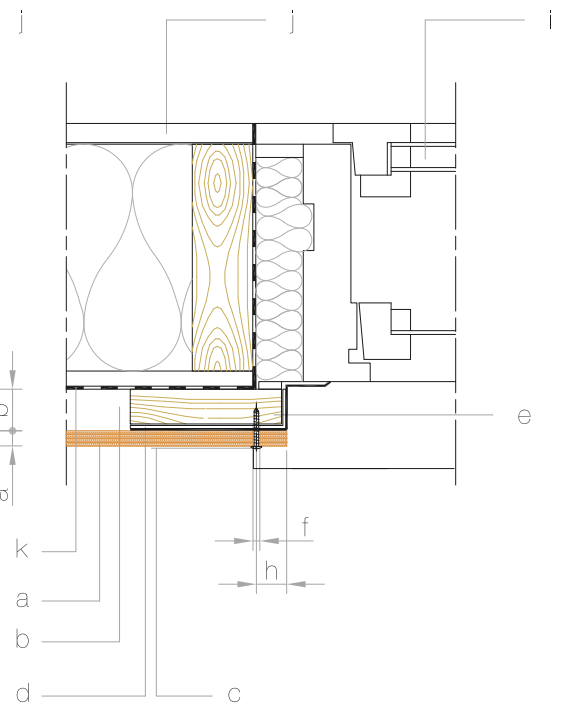

Figure 1. Window detail

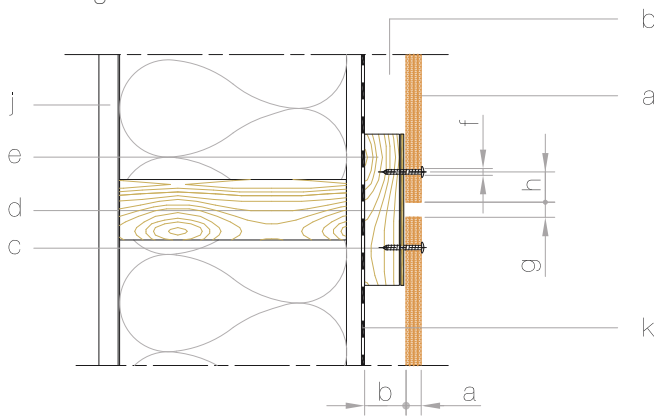

Figure 3. Vertical panel joint

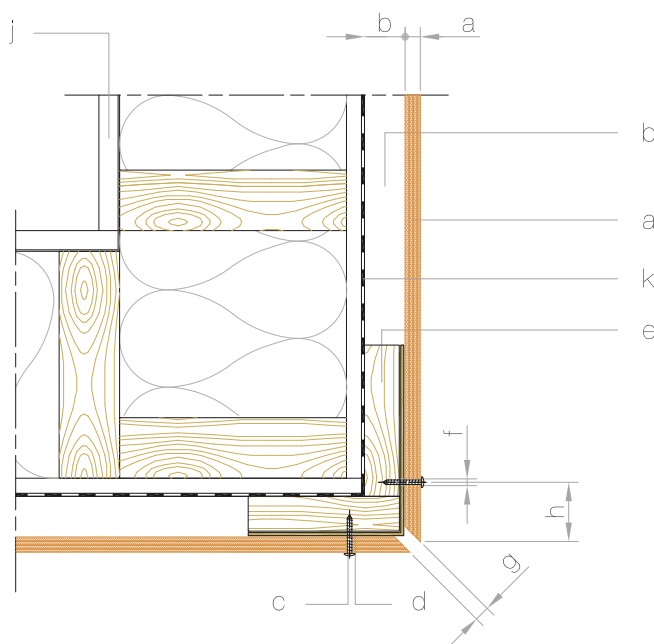

Figure 4. External corner

Scale 1:5

- a VVX® Panel thickness: 6, 8 or 10 mm
- b Air cavity: 20 mm (min.)
- c Stainless steel screw
- d EPDM rubber strip
- e Vertical timber batten
- f Hole diameter: 1.5 x stainless screw diameter
- g Min. joint dimension: 10 mm
- h Edge distance: min. 20 mm - max. 10 x panel thickness
- i Window
- j Load bearing wall
- k Weather resistive barrier

Construction details
 Wooden substructure
 Visible attachment
 Vertical cross-section

Scale 1:10

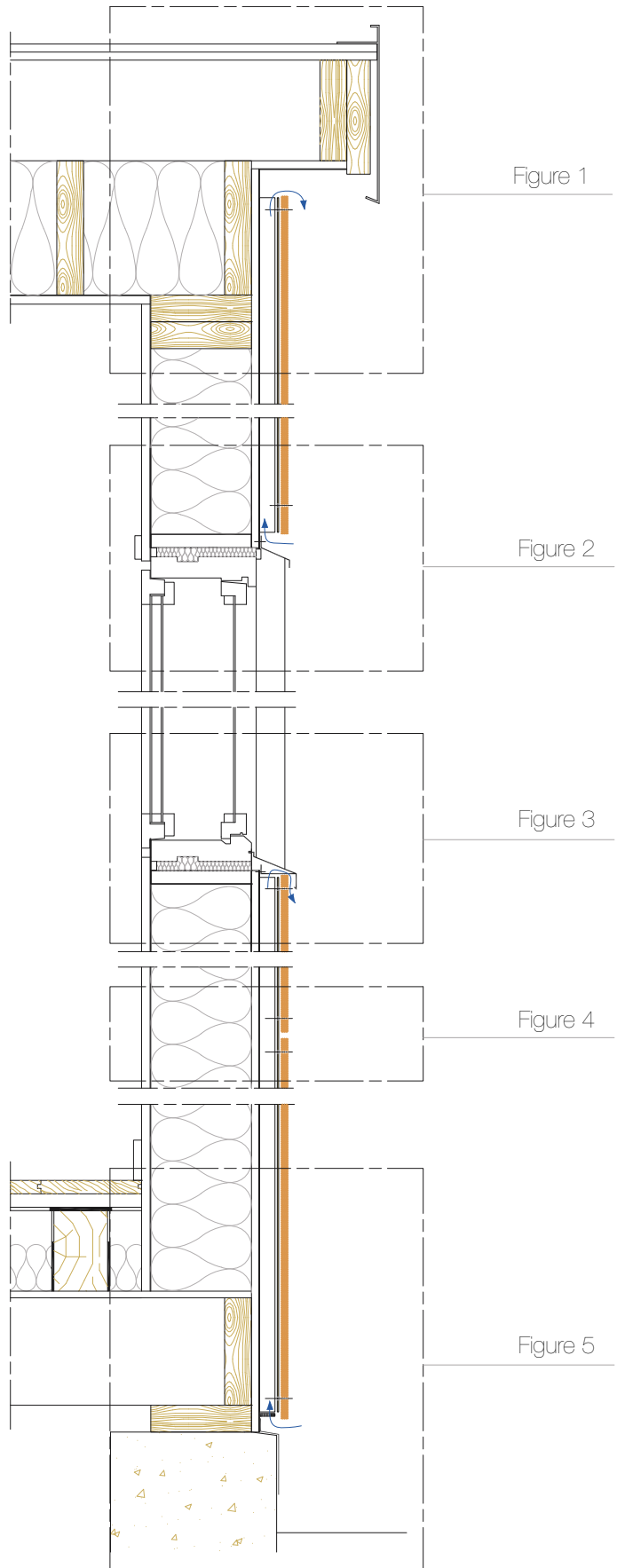

This drawing indicates a typical fixing arrangement on a wooden supporting structure. Please contact your Formica Group representative for other possibilities. Any information or suggestions concerning applications, specification or compliance with regulations and standards is provided solely for your convenient reference and without any representation as to accuracy or suitability. The user must verify and test the suitability of any information or products for his or her particular purpose or specific application.

Technical drawings in this brochure should be considered as general examples of how VIVIX® panels can be installed, there are other profiles and systems available in the market for ventilated façades which are not shown in this brochure. Consideration needs to be given to local circumstances, for example climate, wind load and local building regulations.

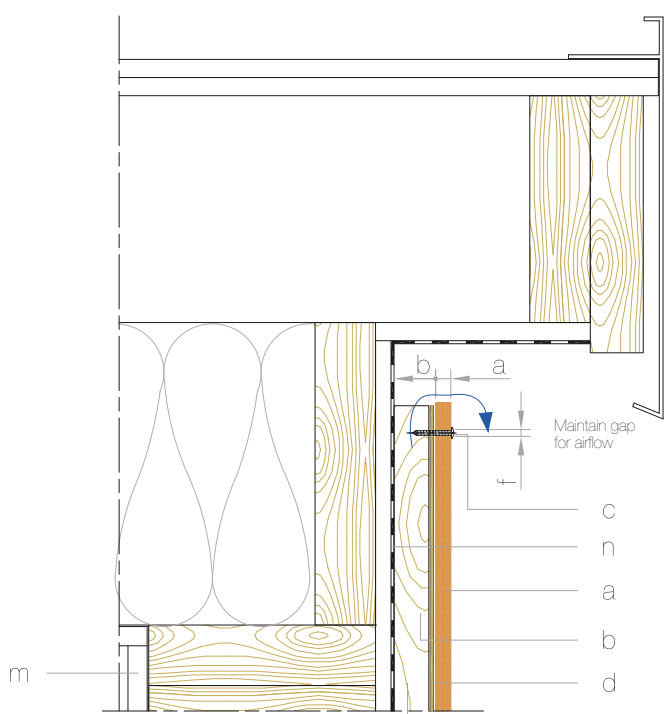

Figure 1. Top of wall

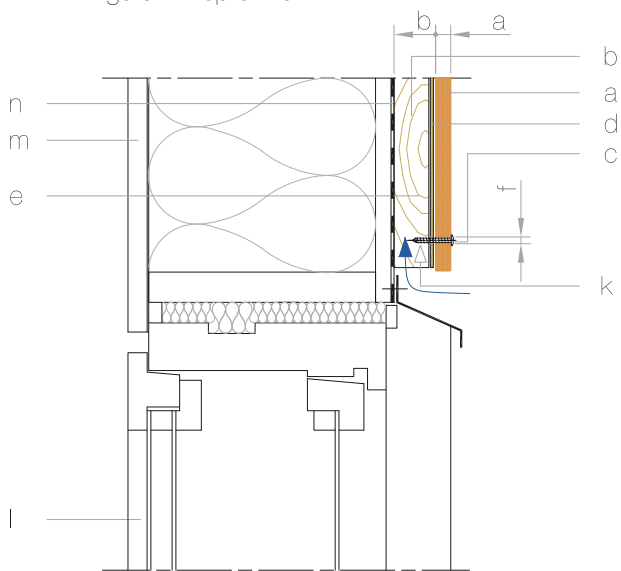

Figure 2. Window head

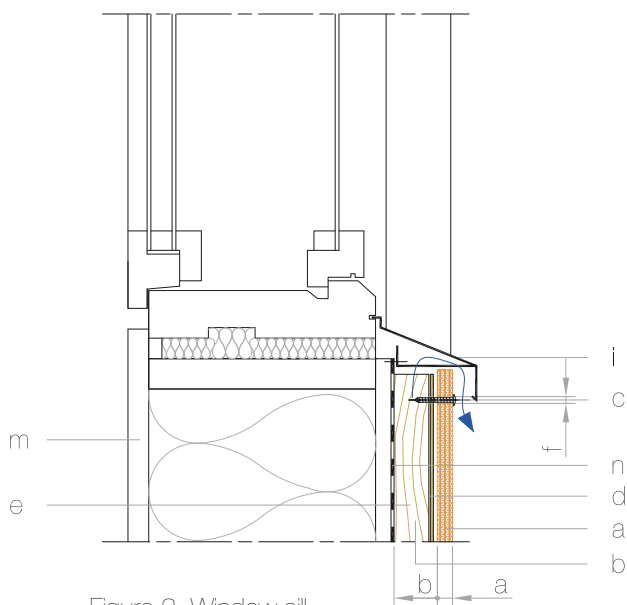

Figure 3. Window sill

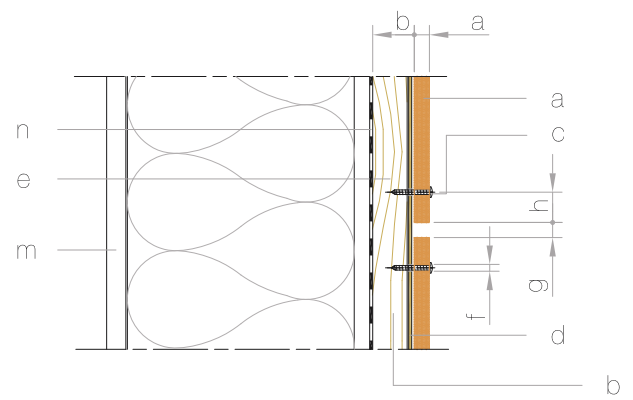

Figure 4. Horizontal panel joint

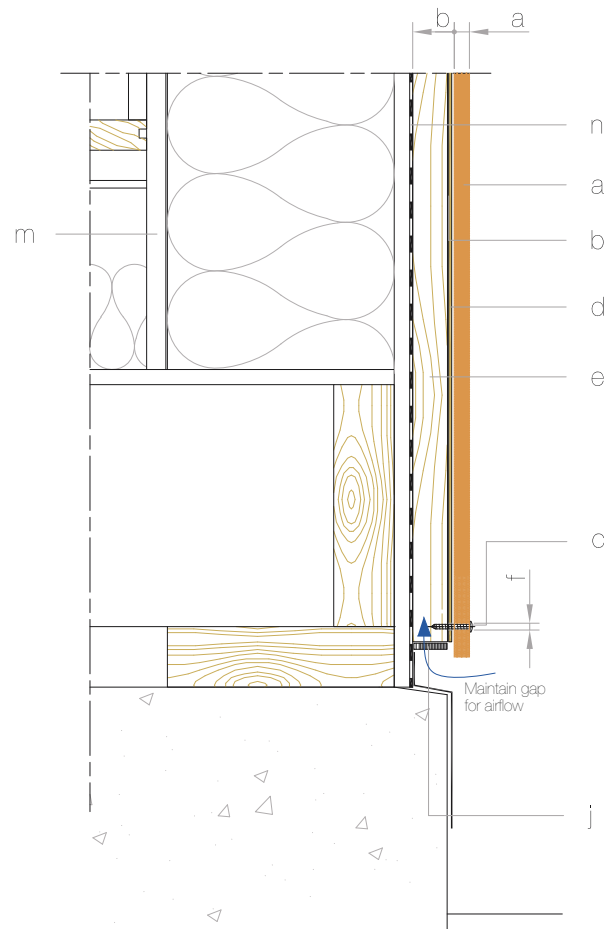

Figure 5. Bottom of wall

Scale 1:5

- a VIVIX® Panel thickness: 6, 8 or 10 mm
- b Air cavity: 20 mm (min.)
- c Stainless screw
- d EPDM rubber strip
- e Vertical timber batten
- f Hole diameter: 1.5 x stainless screw diameter
- g Min. joint dimension: 10 mm
- h Edge distance: min. 20 mm - max. 10 x panel thickness
- i Formed metal sheet
- j Ventilation grille
- k Ventilation distance: 50 cm²/m (min.)
- l Window
- m Load bearing wall
- n Weather resistive barrier

Components of the ventilated façade

VIVIX® architectural panels - a variety of sizes

The choice of panel formats provides flexibility to adapt the panels in the most cost effective and suitable combination for façades or building elements. Please refer to page 33 for specific panel sizes.

Substructure

The substructure may be made up of:

- Metallic brackets (L)
- Vertical profile (T)
- Timber battens.

Elements used for attachment of VIVIX panels to the substructure

Panels are attached to the substructure using screws, rivets or other hidden attaching devices.

Calculations for façade systems

Loads to be taken into consideration.

The loading to be factored into calculating the façade system is worked out using the weight of the panels themselves and the wind load. The effects of variations in temperature or humidity do not need to be taken into account when the system has been calculated and executed properly.

The installer must take into account local wind load and national building regulations.

VIVIX panel weights

Thickness	4.5 mm	6 mm	8 mm	10 mm
Weight per m ²	6.5 kg	8.7 kg	11.6 kg	14.5 kg

Note: EN438 minimum density is 1.35 gr/cm³.

Wind load

Wind load is transmitted through panels to the substructure and unloaded through the supporting wall.

Calculations are performed on a project basis by assigned engineers. Please contact your preferred system manufacturer or installer who will be able to provide the necessary values and calculations. Your Formica Group representative can provide contact information, if necessary.

Design

The following recommendations need to be taken into consideration:

- The minimum distance between a drilled hole and the edge of the VIVIX panel should be 20 mm (or 75 mm concealed) and the maximum distance should be the panel thickness x 10.
- The minimum space between VIVIX panels should be no less than 10 mm.

- The maximum distance between screws / rivets depends on the thickness of the panel:

	6 mm	8 mm	10 mm
2 fixings in one direction	450 mm	600 mm	750 mm
3 or more fixings in one direction	550 mm	750 mm	900 mm

- VIVIX panels in 4.5mm thickness can for example be used in balcony panel applications. The maximum distance between screws / rivets for 4.5 mm thick panels is 300 mm.

Setting up the system

The system should be installed by skilled and experienced fitters using the appropriate tools and equipment.

The system profile should be perfectly level and flat, particularly when using panels of 6 mm thickness.

The system manufacturer's instructions must be followed carefully especially with regard to the attachment of the parts of the profile to allow for its expansion differential for thermal loads.

VIVIX panels should be pre-conditioned, outdoors on site, for a period of 72 hours before installation.

Care should be taken to shield the protective film on the surface of the panels from solar radiation or other heat sources during pre-conditioning and storage.

The protective film should be removed from both sides of the panel simultaneously before installation.

VIVIX architectural panels, should be transported packed on the specially supplied pallets and should be stored on flat pallets and covered with a cap sheet. Care should be taken to shield the protective film on the surface of the panels from solar radiation or other heat sources during pre-conditioning and storage.

Lift the panels straight up, do not slide the panels against each other.

The protective film should be removed from both sides of the panel simultaneously before installation.

Certificates

Avis Technique (Technical Opinion) N° 2/03-984-985, Centre Scientifique et Technique du Bâtiment (CSTB).

Document for Technical Suitability (DIT), Eduardo Torroja.

Euroclass B-s1,d0 Fire Retardant Certificate in accordance with European regulation EN 13501-1.

VIVIX panels are certified by the CE Mark to meet or exceed conformity with European consumer safety, health and environmental requirements.

Certificate N° E203388 for Quality Management Systems, (ISO 9001:2000), Lloyd's Register Quality Assurance Limited.

GreenGuard Air Quality Certification for Low Emitting Products, GreenGuard® Environmental Institute.

Formica Group are FSC® certified and comply with the requirements of FSC. Network of participating European Formica Group sites is shown on certificate number TT-COC-003588.

Please note, not all sizes of panel are available with all certifications.



Please note, not all sizes of panel are available with all certifications.

Formica Group is committed to making sustainable principles and practices a part of everything we do. We strive to adhere to the highest ethical standards as we advance in our efforts to protect vital resources for future needs.

Physical properties

Property	Standard & Clause	Standard Value	
		EDF Exterior grade, severe use, flame-retardant grade	EDS Exterior grade, severe use, standard grade
Thickness Tolerance	EN 438-2-5	6 mm +/-0.4 mm 8 mm +/-0.5 mm 10 mm +/-0.5 mm	
Flatness Tolerance	EN 438-2-9	6 mm 5 mm/m 8 mm 5 mm/m 10 mm 3 mm/m	
Length Width Tolerance	EN 438-2-6	+10 mm/-0	
Straightness of Edge Tolerance	EN 438-2-7	1.5 mm/m max deviation	
Flexural Modulus	EN ISO 178	9000 MPa (min)	
Flexural Strength	EN ISO 178	80 MPa (min)	
Tensile Strength	EN ISO 572-2	60 MPa (min)	
Density	EN ISO 1183	1.35 g/cm ³ (min)	
Impact Resistance	EN 438-2-21	height 1800 mm (D = 10 mm. max.)	
Resistance to Wet conditions	EN 438-2-15	mass increase 8% (max) appearance grade 4 (min)	mass increase 5% (max) appearance grade 4 (min)
Dimensional Stability at Elevated Temperature	EN 438-2-17	L 0.3% (max) T 0.6% (max)	
Resistance to UV Light	EN 438-2-28	contrast min 3 after 1500 hrs appearance min 4 after 1500 hrs	
Resistance to Artificial Weathering	EN 438-2-29	contrast min 3 after 650 MJ/m ² appearance min 4 after 650 MJ/m ²	
Resistance to Climatic Shock	EN 438-2 - 19	flexural strength index (Ds) 0.95 (min) flexural modulus index (Dm) 0.95 (min) appearance grade 4 (min)	
Fire Test (SBI)	EN 13501-1	B-s1,d0	D-s2,d0
Oxygen Index	ISO 4589-2	45% (min)	
Thermal Conductivity	EN 12524	0.3 w/mk	

Project References

- Page 2 Guggenheim Museum Bilbao. Artist: Daniel Buren. Photography: Aitor Ortiz
- Page 4 Complex Esportiu Aquatic L'Argila. Valencia. Architect: AC Architecture S.L.P. Emilio Conejero. Photography: Estudio Carlos Gutiérrez
- Page 6 Hotel Beatriz & Spa. Albacete. Architect: Rafael Martínez Concha. Photography: Marcos Morilla
- Page 8 Hotel La Naval. Sestao, Vizcaya. Architect: Javier Muñoz. Photography: Jorge Flores
- Page 10 Secondary School. Ondarroa, Vizcaya. Architect: Dueñas. Photography: Jorge Flores
- Page 12 Quality Spa & Resort Son. Norway. Architect: Halvorsen og Reine AS. Photography: Fotograf Morten Brakestad
- Page 14 Water Treatment Center. Lemoiz, Vizcaya. Architect & Developer: Consorcio de Aguas y Gaz Arquitectos. Photography: Jorge Flores
- Page 16 Tomás Bodero Industrial Pavilion. Burgos. Architect: Marco Rico. Photography: Jorge Flores
- Page 18 Housing in Finland. Architect: Pentti Kareoja / ARK-House. Photography: Jussi Tiainen
- Page 20 Housing in Norway. Architect: Borealis Arkitekter. Photography: Arthur Arnesen
- Page 22 Toll booth. Variante sur metropolitana of Bilbao, Supersur. Property of: Foral Government of Vizcaya. Architect: Acxt – Idom. Photography: Jorge Flores
- Page 24 Mesoiro Civic Center. A Coruña. Architect: Naos Arquitectura. Photography: Marcos Morilla, Santos Díez
- Page 26 Housing in Boras, Sweden. Architect: DHT Arkitekter, AB / Sven Hedlund
Housing in Leganés, Madrid. Architect: Ricardo Rodríguez Junyent. Photography: Marcos Morilla
Private home in Valencia. Photography: Marcos Soria
San Chinarro Primary School. Madrid. Architect: Technical Services, Madrid City Hall. Photography: Marcos Morilla
- Page 27 Geriatric Hospital in Unbe, Vizcaya. Architect: Emilio Puertas. Photography: Jorge Flores
Housing in Lemoiz, Vizcaya. Architect: Javier Muñoz. Photography: Jorge Flores
Estación Ave Antequera. Málaga. Architect: Tífsa – Ineco. Photography: Juan Carlos Teuma
Building entrances in Viana, Navarra. Developer: Dragados. Photography: Jorge Flores
- Page 28 CEIP. Lleida. Architect: Actar Architecture ASS, S.L., (Manuel Gausa & Florence Raveau). Photography: Verónica Escudero
Private Home in Denmark. Architect: Mads Lützen
Housing in Sestao, Vizcaya. Architect: Ana Díaz (Department of housing and regional planning. The Basque Government)
Photography: Jorge Flores
- Page 29 Housing in Sweden. Architect: WSP Arkitektur
Housing in Carranza, Vizcaya. Architect: Estudio de Arquitectura Edos. Photography: Jorge Flores
Toll booth. Variante Sur Metropolitana Bilbao, Supersur. Architect: Acxt – Idom. Photography: Jorge Flores
Customs building in Finland. Architect: Hannu Kiiskilä, ARRAK Arkkitechdit Oy

Austria

Tel: +49 (0) 180 367 64 22
austria@formica.com

Belgium

Tel: +32 2 705 18 18
contact.belgie@formica.com

Denmark

Tel: +45 43 58 82 00
info.danmark@formica.com

Finland

Tel: +358 3 5800 200
info.finland@formica.com

France

Tel: +33 (0) 3 87 29 10 13
service.echantillons@formica.com

Germany

Tel: +49 (0) 180 367 64 22
kontakt.deutschland@formica.com

Holland

Tel: +31 (0) 70 413 48 20
contact.nederland@formica.com

Ireland

Tel: +353 1 872 4322
samples.uk@formica.com

Italy

Tel: +39.011.9027092
italia@formica.com

Middle East

Tel: +971 4 3219791
middle.east@formica.com

Norway

Tel: +47 800 13 016
info.norge@formica.com

Poland

Tel: +48 22 516 20 84/85
info.polska@formica.com

Russia

Tel: +7 495 646 07 25
Samples tel: +8 800 333 11 63
russia@formica.com

Spain

Tel: +34 902 11 47 73
muestras@formica.com

Sweden

Tel: +46 42 38 48 30
info.sverige@formica.com

Switzerland

Tel: +41 44 818 88 18
schweiz@formica.com

United Kingdom

Tel: +44 191 259 3100
Samples tel: +44 191 259 3512
samples.uk@formica.com



formica.com